

COSMIC

2017

CATALOGUE
CATÁLOGO

COSMIC

Stimulation, relaxation, comfort...
the bathroom reintroduces us to
ourselves through objects that
transcend the merely functional.

Activarse, relajarse, sentirse cómodo...
en el baño nos reencontramos con
nosotros mismos, a través de una
serie de objetos que trascienden lo
meramente funcional.



Bath Experiences

004 COSMIC

006 THE CREATORS
LOS CREADORES

024 SHOWROOM



026 FURNITURE WITH WASHBASIN
MOBILIARIO CON LAVABO

028 **Block**

050 **Block Evo**

072 **Container**

088 **Global Container**

104 **Modular**

166 **The Grid**



194 WASHBASINS
LAVABOS

196 **Compact**

210 **Container**

220 **Global Container**

230 **Fancy**

248 **Mix**

256 **Modular**

266 **The Grid**



270 BAHTUBS
BAÑERAS

272 **Mix**

276 **Up Grade**



282 FAUCETS
GRIFERÍA

284 **Control**

290 **Flow**



294 LIGHTING
ILUMINACIÓN

296 **Light**



300 MIRRORS
ESPEJOS

302 **Basic**

308 **Container**

314 **Global Container**

322 **Flow**

328 **Led Lighting**

334 **Modular**

342 **The Grid**



348 ACCESSORIES
ACCESORIOS

350 **Architect**

368 **Bath Life**

380 **Black & White**

390 **Container**

400 **Contract**

410 **Extreme**

420 **Logic**

432 **Minimalism**

444 **Project**

456 **The Grid**

468 **Working**



480 FREE STANDING ACCESSORIES
COMPLEMENTOS

482 **Saku**

489 DISPLAYS

494 MATERIALS
MATERIALES

498 SALES CONDITIONS
CONDICIONES DE VENTA







Cosmic

Cosmic conceives the bathroom as an reflection of a person's personality and the search for wellbeing through design. One of the most global and suggestive offers on the market: accessories, furniture, washbasins, bathtubs, shower trays, fittings, lightings, mirrors and free-standing accessories.

Cosmic entiende el cuarto de baño como un reflejo más de la personalidad de cada individuo y su búsqueda del bienestar a través del diseño. Una de las ofertas más globales y sugestivas existentes en el mercado: accesorios, muebles, lavabos, bañeras, platos de ducha, grifería, iluminación, espejos y complementos.





Miquel de Mas



Xavier Claramunt



Willi Kunzel



Núria Coll



Martín Ruiz Azua



Gerard Moliné



Jonathan Daifuku



Carles Ferruz

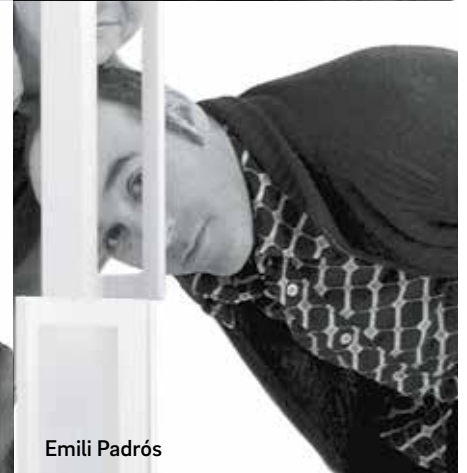

Emili Padrós



Ana Mir

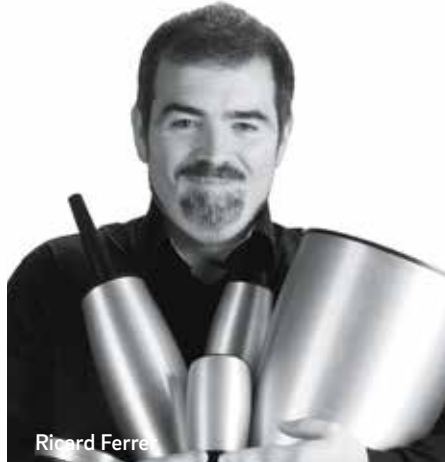

Ricard Ferré



Àlex Armenter

The creators

Los creadores

Over the years the Cosmic Studio has been designing and developing numerous collections that have become classics. It has also collaborated with and coordinated work by renowned designers.

A lo largo de la historia Cosmic Studio ha diseñado y desarrollado multitud de colecciones que se han convertido en clásicos, y ha colaborado y coordinado el trabajo de reconocidos diseñadores.



1993



Architect

A multitude of pieces come out of architectonic forms that dominate with their resistance. Full collection of accessories, converted into a classic.

De las formas arquitectónicas surgen multitud de piezas que destacan por su resistencia. Colección completa de accesorios convertida en un clásico.

Cosmic Studio

"A vocation for design. We rely on the creator as someone capable of successfully bringing the concept we want to convey to the consumer."

Team dedicated to innovation and researching new designs and materials.

"Vocación por el diseño. Apostamos por la figura del creador como alguien capaz de materializar el concepto que queremos transmitir al consumidor."

Equipo dedicado a la investigación de nuevos diseños y materiales y a la innovación.

1998



Inox

The resistance of steel combines with the most contemporary forms resulting in intensely sober and elegant pieces.

La resistencia del acero se une a las formas más contemporáneas dando como resultado piezas extremadamente sobrias y elegantes.

Cosmic Studio

1999



Ozone

A minimalist basin ideal for small spaces which can be complemented by a towel bar.

Lavabo mínimo para espacios reducidos que opcionalmente puede incorporar un toallero doble.

Ricard Ferrer

Barcelona - España, 1968

"I like simple products, those which offer functionality without any pretension, that are elegant, those that fulfil their purpose."

Product designer from the Elisava School and the Llotja School in Barcelona, with a top-up BA in Design from the University of Southampton.

Nominations in the Delta Adi-fad awards and first prize in both 2001 and 2003 in the Expohogar design competition.

"Me interesan los productos simples, los que ofrecen el uso sin más pretensiones, los elegantes, los que cumplen lo que prometen."

Diseñador de producto por la Escuela Elisava y Llotja en Barcelona, BA top in design de la Universidad de Southampton.

Selecciones en los premios Delta Adi-fad y primer premio 2001 y 2003 en el concurso de diseño Expohogar.



Liria

The poetry and beauty of the flower make this lavatory brush a gift item.

La poesía y la belleza de la flor convierten el escobillero en un objeto de regalo.



Logic

Pieces that bring together the functions and basic forms of the bathroom to create comfortable and pleasant ambiances.

Piezas que recogen los usos y formas básicas del baño para crear ambientes confortables y cómodos.



Minimalism

Maximum wellbeing in the bathroom environment with minimum elements.

El máximo bienestar en el entorno del baño con mínimos elementos.

Javier Mariscal

Valencia - España, 19505

"To surprise first, to fascinate, later. And finally, to convince. This is our strategy."

Graphic designer from the Elisava School in Barcelona who has devoted his career to furniture design, interior design, graphic design, landscaping, painting, sculpture, illustration, web and multimedia design and animation. All of these disciplines form the basis of his professional activity.

"Sorprender primero, fascinar después. Finalmente convencer. Esta es nuestra estrategia."

Diseñador gráfico por la Escuela Elisava de Barcelona ha dedicado su carrera al diseño de mobiliario, el interiorismo, el diseño gráfico, el paisajismo, la pintura, la escultura, la ilustración, el diseño web y multimedia y la animación. Todas estas disciplinas son objeto de su actividad profesional.

Cosmic Studio



Cosmic Studio



2001



Lux Gold

Golden Lux award in the Fashion and Advertising category for the campaign conducted by artistic director Jaume de Laiguana for Cosmic. The project presented powerful photographs from choreographer Nacho Duato, who was managing the Spanish National Dance Company at the time.

Lux de Oro en la categoría de Moda y Publicidad por la campaña realizada por el director artístico Jaume de Laiguana para Cosmic. El trabajo presentaba fotografías impactantes del coreógrafo Nacho Duato, que en aquel momento dirigía la Compañía Nacional de Danza de España.

Aluminium

Top level technical and functional features are blended together in refined and avantgarde aesthetics, with bathroom spaces explicitly in mind.

Altas prestaciones técnicas y funcionales se funden en una estética depurada y vanguardista, especialmente ideada para espacios de baño.

System

A collection of bathroom accessories designed to create decor sets by freely distributing mirrors, cupboards and shelves in aluminium base frames.

Muebles auxiliares de baño para configurar conjuntos a partir de espejos, armarios y repisas que pueden distribirse libremente en los marcos base de aluminio.

Jonathan Daifuku

Boston - USA, 1954

"Creator of timeless pieces that combine understated practicality with different multicultural influences."

Architect from the School of Fine Arts in Paris. Bachelor in "Environmental Design and Architecture" from Rhode Island School of Design in the USA.

Finalist in the Lighting for Tomorrow competition with the Wave project. (2003).

"Creador de objetos intemporales que combinan una sobria funcionalidad con varias influencias multiculturales."

Arquitecto por la escuela de Bellas Artes de París. Bachelor en "Enviromental Design y Architecture" por Rhode Island School of Design en USA.

Finalista en el concurso Lighting for Tomorrow con el proyecto Wave. (2003).

Ricard Ferrer



Lux Silver

Silver Lux award for the campaign conducted by the artistic director Jaume de Laiguana for Cosmic. The proposal presented spectacular images of famous models such as Martina Klein, Eulalie Martine, Verónica Blume and Bimba Bosé, who appeared naked, surrounded by smoke, rubbish and freezing water, in order to condemn the pollution of the planet.

Lux de Plata por la campaña creada por el director artístico Jaume de Laiguana para Cosmic. La propuesta presentaba imágenes espectaculares de famosas modelos como Martina Klein, Eulalie Martine, Verónica Blume o Bimba Bosé, que aparecían desnudas rodeadas de humo, basura o aguas heladas para denunciar la contaminación del planeta.



Container

A set of shelves, containers and washbasin built at different levels to help with organisation.

Conjunto de estantes, containers y lavabo construido a diferentes niveles con el objetivo de marcar un orden.

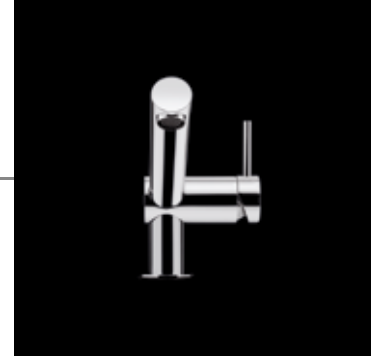

Control

Extraordinarily subtle design and high technology to fulfil a simple and elementary concept.

Diseño extraordinariamente sutil y alta tecnología al servicio de un concepto simple y elemental.

Xavier Claramunt

Igualada, Barcelona - España, 1965

"Experience architect."

Architect from the Advanced Technical School of Architecture in Barcelona. Master Craftsman from the Government of Catalonia.

He became known as a jewellery designer, really took off as a successful aeronautical engineer and then took a wild leap and ended up as an unpredictable architect.

"Arquitecto de experiencias."

Arquitecto por la Escuela Técnica Superior de Arquitectura de Barcelona. Maestro Artesano por la Generalitat de Catalunya.

Se dio a conocer como diseñador de joyería, despegó como ingeniero aeronáutico para saltar en pleno vuelo y aterrizar como arquitecto impredecible.

Xavier Claramunt y Miquel de Mas



2003



Príncipe Felipe

Príncipe Felipe award for Business Excellence 2003 for marketing, management and design management. These awards, granted by the Ministry of Finance and the Ministry of Science and Technology, aim to give public recognition to those Spanish companies that have made a substantial effort to improve their competitiveness factors, as well as to encourage other companies to continue working on the path towards excellence.

Premio Príncipe Felipe a la Excelencia Empresarial 2003 por marketing, gestión y gestión del diseño. Estos premios, otorgados por los ministerios de Economía y de Ciencia y Tecnología, tienen como objetivo hacer un reconocimiento público de aquellas empresas españolas que han realizado un importante esfuerzo por mejorar sus factores de competitividad, así como animar a otras empresas a seguir trabajando por el camino de la excelencia.

Premio a la calidad del diseño en la empresa

Business Design Quality award 2003, presented by BCD (Barcelona Design Centre) and the Barcelona Chamber of Commerce.

Premio a la Calidad del Diseño en la Empresa 2003, presentado por BCD (Barcelona Design Centre) y la Cámara de Comercio de Barcelona.

Liquid

Special quality material for the moist atmosphere of the bathroom and extraordinarily aesthetic beauty based on the most elementary and avantgarde forms.

Materiales con altas prestaciones para el ambiente húmedo del baño y extraordinaria belleza estética basada en las formas más elementales y vanguardistas.

Núria Coll y Willi Kunzel

Badalona - España, 1973
Dachau - Germany, 1968

"Agility and creativity. New perspectives in the field of design."

NC: Winner of first prize in the professional category of the Manacor furniture competition (Mallorca).

WK: Design at the Akademie Industrielle Vormengeving in Eindhoven, The Netherlands, and at the Elisava School in Barcelona. Collaborator in the European Design Centre for the Volkswagen group.

"Agilidad y creatividad. Nuevos puntos de vista en el diseño."

NC: Ganadora del Primer Premio profesional de Mobiliario de Manacor (Mallorca).

WK: Diseño en la Akademie Industrielle Vormengeving de Eindhoven, Holanda y en la Escola Elisava de Barcelona. Colaborador en el Design Center Europe del Grupo Volkswagen.



With

Wall-hung washbasins with rounded edges that are complemented with very practical auxiliary trolleys.

Lavabos de pared suspendidos y con acabados redondeados que se complementan de carros auxiliares muy prácticos.

Xavier Claramunt y Miquel de Mas

Igualada, Barcelona - España, 1965
Barcelona - España, 1975

"Experience architect."

"As a sceptic, I seek originality and discover innocence."

XC: Architect from the Advanced Technical School of Architecture in Barcelona. Master Craftsman from the Government of Catalonia.

He became known as a jewellery designer, really took off as a successful aeronautical engineer and then took a wild leap and ended up as an unpredictable architect.

MDM: Interior designer from the Rubí Municipal School of Fine Arts (Barcelona) and technician of Interactive Multimedia Systems from UOC-UPC in Barcelona.

He trained as an interior designer but later became an industrial designer. He lives three-dimensionally, navigating digital environments and seeking new challenges.



"Arquitecto de experiencias."

"Incrédulo, busco la originalidad y hallo la inocencia."

XC: Arquitecto por la Escuela Técnica Superior de Arquitectura de Barcelona. Maestro Artesano por la Generalitat de Catalunya.

Se dio a conocer como diseñador de joyería, despegó como ingeniero aeronáutico para saltar en pleno vuelo y aterrizar como arquitecto impredecible.

MDM: Interiorista por la Escuela Municipal de Bellas Artes de Rubí (Barcelona) y técnico en Sistemas Interactivos Multimedia UOC-UPC de Barcelona.

Se formó como interiorista y se transformó a diseñador industrial. Vive las tres dimensiones, navega en entornos digitales y busca nuevos retos.



Working

Based on pure function, without ostentation. Simple forms with an extremely elegant expression.

Basada en la función pura, sin más pretensiones. Formas simples con un gesto extremadamente elegante.

Cosmic Studio



2005



Compact

Be part of the most personal moments. The Compact bathroom collection achieves this air of complicity, with dual functions such as integrated storage drawers.

Ser participe de los momentos más personales. Con la colección de lavabos Compact esta complicitad se consigue, ofreciendo funciones alternativas a la propia como los cajones de almacenamiento integrados.

Cosmic Studio



Organizer

Installations that want to leave the walls where they are hidden and wander through the bathroom surfaces.

Instalaciones que quieren salir de las partes donde están escondidas y pasearse por las superficies del baño.

Xavier Claramunt y Miquel de Mas



Organizer

Metal tubes with hanging neoprene structures for an optimal organization.

Tubos metálicos con estructuras colgadas de neopreno para una organización óptima.

Xavier Claramunt y Miquel de Mas





Premis
Delta'07

△
Delta
Plata

Simplex

Washbasins and polyethylene stools made with a modern and innovative technique that offers rounded, simple and resistant finishes.

Lavabos y taburetes de polietileno fabricados con una moderna e innovadora técnica que permite acabados redondeados, simples y resistentes.

Martín Ruiz Azúa y Gerard Moliné

País Vasco - España, 1965
Barcelona - España, 1977

*"Global communication
for a local life."*

*"Design must also learn from
craftmanship above all from
its ethics and sustainability."*

MRA: Bachelor's degree in Fine Arts (Design) from the University of Barcelona (UB). Postgraduate degree in Architecture and Design of Ephemeral Installations from the Polytechnic University of Catalonia (UPC). Design Plus award 2009 for the Cosmic Flow collection, Interior Designer Plus award 2009, AD award for best designer 2010, Silver Delta award 2011.

GM: Graduate of the Elisava Barcelona School of Design and Engineering. ADI FAD medal 2002, Expohogar Regalo award (2005, 2006), top nominated design in the INDEX 2005 awards. Since 2003 he has worked alongside Martín Ruiz Azúa on different projects.



PREMI DELTA Simplex

Delta de Plata award for its Simplex collection in the 32nd edition of the Delta ADI-FAD awards of Industrial design.

Premio Delta de Plata 2007 por su colección Simplex en la 32ª edición de los premios Delta ADI-FAD de Diseño Industrial.

*"Comunicación global
para una vida local."*

*"El diseño también debe aprender
de la artesanía, sobre todo
ética y sostenibilidad."*

MRA: Licenciado en Bellas Artes (Diseño) por la UB. Postgraduado en Arquitectura y Diseño de Montajes Efimeros por la UPC.

Design Plus 2009 Flow de Cosmic, Premio Interiorismo Plus 2009, Premio AD mejor diseñador del año 2010, Premio Delta de Plata 2011.

GM: Graduado en la Escuela Superior de Diseño Elisava.

Medalla ADI FAD 2002, Premio Expohogar Regalo (2005, 2006), Top Nominated INDEX 2005.

Desde 2003 ha trabajado conjuntamente con Martín Ruiz Azúa en diferentes proyectos.

2005



Contract

Functional forms that do not renounce the touch of elegance that makes them unique.

Formas funcionales que no renuncian a ese toque de elegancia que las convierte en singulares.

Anonymous

Pieces that combine more than one function and offer multiple alternatives: magazine/ toilet paper racks, shelves with hooks...

Piezas que combinan más de una función y ofrecen múltiples alternativas: portarrollos revistero, estante colgador...

Cosmic Studio

Emiliana Design Studio

ANA MIR

Valencia, Barcelona - España, 1969

EMILI PADRÓS

Barcelona - España, 1969

"We offer a fresh approach to every project. Our values consist of experimenting with new materials, objects and spaces."

AM: Bachelor in Fine Arts from the Polytechnic University in Valencia and Master in Industrial Design from the Central Saint Martin's School of Art Design in London (1992-1994).

She teaches at (Gives classes at) the Elisava ESDi School of Design in Barcelona.

EP: Master in Industrial Design from Central Saint Martin's School of Arts and Design in London (1992-1994). Industrial Designer from the Elisava School.

In 1996 he founded the Emiliana Design Studio with Anna Mir for product and furniture development, interior design, curatorship and exhibition design.



"Ofrecemos un renovado enfoque en cada proyecto. Nuestros valores son la experimentación con los materiales, objetos y espacios."

AM: Licenciada en Bellas Artes por la Universidad Politécnica de Valencia y Master en Diseño Industrial por la Universidad Central Saint Martin's School of Art Design de Londres (1992-1994).

Imparte clases en Elisava Escola Superior de Disseny de Barcelona.

EP: Master en Diseño Industrial en Central Saint Martins School of Arts and Design, 1992-94 London. Diseñador Industrial por la Escuela Elisava.

En 1996 funda emiliana design studio junto con Anna Mir para el desarrollo de producto y mobiliario, el interiorismo, el comisariado y diseño de exposiciones.

2006



Bath Life

Set of perfectly straight lines and angles within an exclusive and timeless design.

Conjugación de líneas y ángulos rectos perfectos, de diseño exclusivo y atemporal.



Bath Life

A timeless range, made with fine materials, which evoke pure and sophisticated styles.

Serie atemporal, realizada con materiales nobles, que evoca formas puras y sofisticadas.



Drop

Arising from the image of the drop of water that adapts and flows over surfaces, based on the architectural forms of each object so they are easily recognisable for the user but more rounded, as if they had been eroded by water.

Nace a partir de la imagen de la gota de agua que se adapta y fluye sobre las superficies, partiendo de las formas arquetípicas de cada objeto para que sean fácilmente reconocibles por el usuario, pero más redondeadas, como si estuvieran erosionadas por el agua.

Carles Ferruz

Barcelona - España, 1968

"Avant-garde design and development of integral decoration projects."

Interior designer from the Llotja School in Barcelona.

After 20 years of experience in the sector, in 1993 Carles Ferruz launched FERRUZ DECORADORS at his current location in Barcelona.

"Diseño de vanguardia y desarrollo de proyectos integrales de decoración."

Interiorista por la Escuela Llotja de Barcelona.

Tras 20 años de experiencia en el sector, en 1993 Carles Ferruz abrió las puertas de FERRUZ DECORADORS en su actual sede en Barcelona.

Carles Ferruz



Ricard Ferrer



2007



Saku

Vegetable forms that grow and evolve; thus its name "saku", to flourish in Japanese.

Formas vegetales que crecen y evolucionan, de ahí su nombre "saku", florecer en japonés.



Bi

Simple forms that combine the elegance of steel with the functionality of plastic, seeking excellent performance over and above fashions and trends.

Formas simples que unen la elegancia del acero con la funcionalidad del plástico, y buscan dar un excelente rendimiento más allá de modas y tendencias.



Extreme

Serene balance between sober elegance of rectangular lines and the sensuality of forms.

Sereno equilibrio entre la sobria elegancia de las líneas rectangulares y la sensualidad de sus formas.

Ricard Ferrer



Ricard Ferrer

Cosmic Studio



Project

From the amalgamation of circular and squared forms comes the versatility and functionality of all its elements.

De la conjugación de formas circulares y cuadradas, surge la versatilidad y funcionalidad de todos sus elementos.

Block

Sculpt refined forms. Soften angles. Trace soft lines. Cosmic has cast one of its most emblematic collections, Block, relocating it in time using a new material of exceptionally high quality.

Esculpir formas depuradas. Redondear los ángulos. Trazar líneas suaves. Cosmic ha moldeado una de sus colecciones de lavabos más emblemáticas, Block, resituándola en el tiempo con un nuevo material de una calidad excepcional.

DESIGN PLUS Block

Design Plus Award 2007 for Block collection, given by the German Design Council in collaboration with Messe Frankfurt.

Premio Design Plus 2007 por la colección de mobiliario Block, concedido por German Design Council en colaboración con Messe Frankfurt.

Cosmic Studio

Cosmic Studio



2008



Flow

The sensuality of natural forms blends into a strict and functional geometry.

La sensualidad de las formas naturales se funde en una estricta y funcional geometría.

**Martín Ruiz Azúa
y Gerard Moliné**



2009



DESIGN PLUS Flow

Design Plus Award 2009 for Flow collection, given by the German Design Council in collaboration with Messe Frankfurt.

Premio Design Plus 2009 por la colección Flow, concedido por German Design Council en colaboración con Messe Frankfurt.



Organics

Pieces without edges, moulded by and for use. their design is inspired by the erosion of water, its blurring of contours and how they are moulded to sweeten their profiles.

Piezas sin aristas, modeladas por y para su uso. su diseño se inspira en la erosión del agua y en cómo ésta difumina los contornos y los moldea dulcificando los perfiles.

Ricard Ferrer

2010



Mix

The combination of organic and compact gives the perfect result. A collection with the tranquillity and wellbeing of the bathroom in mind.

La mezcla entre lo orgánico y lo compacto da el resultado perfecto. Una colección especialmente ideada para el relax y el bienestar en el espacio de baño.

Martín Ruiz Azúa

País Vasco - España, 1965

"Global communication for a local life."

Bachelor's degree in Fine Arts (Design) from the University of Barcelona (UB). Postgraduate degree in Architecture and Design of Ephemeral Installations from the Polytechnic University of Catalonia (UPC).

Design Plus award 2009 for the Cosmic Flow collection, Interior Designer Plus award 2009, AD award for best designer 2010, Silver Delta award 2011.

"Comunicación global para una vida local."

Licenciado en Bellas Artes (Diseño) por la UB. Postgraduado en Arquitectura y Diseño de Montajes Efímeros por la UPC.

Design Plus 2009 Flow de Cosmic, Premio Interiorismo Plus 2009, Premio AD mejor diseñador del año 2010, Premio Delta de Plata 2011.



Hiro

Designed for organisation and storage requirements, offering solutions to spaces usually between the toilet and the bathroom fittings.

Pensada para resolver diversas necesidades de organización y almacenaje, aportando soluciones a los espacios que suelen quedar entre los sanitarios y el mobiliario.

Ricard Ferrer



Black & White

The classic colour contrast transforms the bathroom into a bold atmosphere or blends it in to the other components to create harmonious and diaphanous environments.

El contraste cromático más clásico permite transformar el baño en un ambiente atrevido o bien fundirse con el resto de elementos para convertir los entornos en armónicos y diáfanos.

Cosmic Studio



2011



Modular

Modular is the most intelligent and flexible solution for organisation and storage requirements in the bathroom environment.

Modular es la solución más inteligente y flexible para las necesidades de orden y almacenaje en el entorno del baño.

Àlex Armenter

Barcelona - España, 1961

"A good project begins with a good commission"

Architect from the Polytechnic University of Catalonia (UPC).

Architecture and interior design projects for leading companies, including Industrias Cosmic, SAU.

Dedicated to the restoration of buildings in Barcelona and London.

"Un buen proyecto empieza por un buen encargo."

Arquitecto por la UPC.

Proyectos de arquitectura e interiorismo para destacadas empresas entre ellas, Industrias Cosmic, SAU.

Dedicado a la rehabilitación de edificios en Barcelona y Londres.

2013



Fancy

When less is more. Furniture with washbasin, wall and counter top washbasins. Compacted collection and also adaptable to all spaces and needs. Warm and refined forms, because of its rounded edges.

Cuando menos es más. Muebles con lavabo, lavabos a pared y de sobreencimera. Colección compacta y a la vez adaptable a todos los espacios y necesidades. Formas cálidas y depuradas gracias a sus cantos redondeados.

Cosmic Studio

2015



Global Container

Simple lines and innovative concepts reveal an ultracontemporary collection.

Una colección ultra contemporánea por sus líneas básicas y conceptos innovadores.

Xavier Claramunt y Miquel de Mas





Container

The reedition of the original collection with fine materials creates elegant and unique environments.

La reedición de la colección original con materiales nobles permite crear espacios elegantes y únicos.



Suite

After thirty years of creating exclusive bathrooms, Cosmic is going the extra mile with the launch of its first collection of high quality screens and partitions.

Después de treinta años de experiencia creando los mejores entornos de baño, Cosmic da un paso adelante y lanza al mercado su primera colección de mamparas y divisorias de alta gama.



The Grid

Parallel lines which frame objects specifically designed for an architecturally engineered bathroom.

Líneas paralelas que enmarcan objetos dedicados a un baño concebido desde la óptica arquitectónica.

**Xavier Claramunt
y Miquel de Mas**

Cosmic Studio

Ricard Ferrer





Showroom

Cosmic Showroom, situated at the central office of Industrias Cosmic, S.A.U., is a place to experience the contact with the product. Washbasins, bathtubs, shower trays, cabinets, faucets and accessories...

Cosmic showroom es un espacio situado en la sede central de Industrias Cosmic, S.A.U. donde disfrutar de la experiencia del contacto con el producto. Lavabos, bañeras, duchas, mobiliario, griferías y accesorios...



CERDANYA, 2
POL. IND. LA BORDA
P.O. BOX 184
08140 CALDES DE MONTBUI
T. +34 938 654 277
info@icosmic.com
www.icosmic.com





Furniture with washbasin

Mobiliario con lavabo

- 028 **Block**
 - 050 **Block Evo**
 - 072 **Container**
 - 088 **Global Container**
 - 104 **Modular**
 - 166 **The Grid**
-



Block

Design by **Cosmic Studio**







779 121 403 102 064 (X2)
2 DRAWER CABINET WITH BIOBASED MATTE WASHBASIN
MUEBLE 2 CAJONES CON LAVABO BIOBASED MATE
(80.5X50X52CM)



Sculpt refined forms. Soften angles.
Trace soft lines. Cosmic has cat one of its
most emblematic collections, Block,
relocating it in time using a new material
of exceptionally high quality.

Esculpir formas depuradas. Redondear
los ángulos. Trazar líneas suaves.
Cosmic ha moldeado una de sus colecciones
de lavabos más emblemáticas, Block,
resituándola en el tiempo con un nuevo
material de una calidad excepcional.

779 121 403 102 064
2 DRAWER CABINET WITH BIOBASED MATTE WASHBASIN
MUEBLE 2 CAJONES CON LAVABO BIOBASED MATE
(80.5X50X52CM)

779 001 407 102 064
CABINET
ARMARIO
(40X26X80CM)









779 121 803 110 110
2 DRAWER CABINET WITH BIOBASED MATTE WASHBASIN
MUEBLE 2 CAJONES CON LAVABO BIOBASED MATE
(100X50X52 CM)

779 001 407 110 110
CABINET
ARMARIO
(40X26X80 CM)







779121403108108
2 DRAWER CABINET WITH BIOBASED MATTE WASHBASIN
MUEBLE 2 CAJONES CON LAVABO BIOBASED MATE
(80X50X52 CM)









Self & soft close with new rail system which can be completely removed. The inside of the drawers is comprised of compartments so that items can be neatly organized.

Apertura y cierre amortiguado con guías de extracción total ocultas soft & self close. El interior de los cajones se presenta con contenedores para distribuir los utensilios de forma organizada.

The drawers, with a handle in the side, are completely removable to let the most pleasant use.

Los cajones, con tirador integrado en el lateral, se extraen totalmente permitiendo un uso muy cómodo.

Block has successfully passed the high demanding tests of long last durability and resistance to extreme uses (static charge or impact testing) to assure long last durability of the product.

Toda la gama **Block** ha superado con éxito exigentes tests de durabilidad y resistencia a usos extremos (cargas estáticas o test de impacto), para asegurar una larga vida al producto.



Leg set (optional).

Pies opcionales.



Eco friendly: furniture made in Spain with certified wood board (PEFC/FSC) following the chain of custody in forestry.

Producto ambientalmente responsable: muebles fabricados en España con tableros de madera certificada (PEFC/FSC) conforme la cadena de custodia de productos forestales.



Cabinet with aluminium shelves.

Armario con estantes en aluminio.



Lacquered finishing and high quality laminate. Colours unalterable.

Acabados lacados de alta gama. Los tonos se mantienen inalterables a lo largo del tiempo.





100% recyclable: 100% of the material can be recovered.

Reciclable 100%: puede ser reemplazado y utilizado al final de la vida como inerte.

 **CRISTALPLANT®
BIOBASED**

Less CO₂: 30% lighter which not only allows for easier manipulation and installation but produces less CO₂ than other similar products.

Menos CO₂: composición muy ligera, ha reducido su peso específico en un 30%, produciendo, por tanto, menos CO₂ con respecto a productos similares disponibles actualmente en el mercado, además de facilitar su manipulación e instalación.

Solid Surface Biobased Washbasins

Cristalplant® Biobased Washbasins: unique compound material, technologically advanced, made up of 50% natural minerals (aluminium trihydrate -ATH- derived from bauxite) and 50% high-purity polyester bioresins. An inert, hypoallergenic, non-toxic material.

Solid Surface Biobased Washbasins

Lavabos de Cristalplant® Biobased: material compuesto, tecnológicamente avanzado y único, formado por un 50% de minerales naturales (trihidrato de aluminio -ATH- derivado de la bauxita) y un 50% de biorresinas de poliéster de gran pureza; se trata, por lo tanto, de un material inerte, hipoalérgico y no tóxico.

Plant resins: this is the first ecologically sustainable solid surface derived from plant resins mixed with highly pure natural minerals. Some 30% of the resin component, formerly of fossil origin, has been replaced with polyesters of plant origin from certified growers.

Resinas de origen vegetal: es el primer solid surface eco sostenible que deriva de materias primas resinosa de origen vegetal mezcladas con minerales inertes y naturales de extrema pureza. El 30% de la resina, anteriormente de origen fósil, ha sido substituida por poliésteres de origen vegetal procedentes de cultivos certificados.

Non-GMO: VOC (Volatile organic compounds) and BIO-BASED points awarded for the eco-sustainability certificate "Leadership in Energy and Environmental Design". This material has been certified as containing resins derived from vegetable starches and non-GMO corn. While the minimum requirement is 5%, these resins reach 12% in our product.

Sin OGM: es un material idóneo para obtener puntuación VOC (Compuestos Orgánicos Volátiles) y BIO-BASED para el certificado de eco-sostenibilidad "Leadership in Energy and Environmental Design". El material obtuvo el certificado que confirma que las resinas derivan de almidones vegetales y maíz sin OGM (organismos genéticamente modificados); en el material, dichas resinas superan incluso el 12%, cuando el requisito mínimo es normalmente del 5%.



Washbasins | Lavabos

Durable and recoverable: this material regains its original appearance using soapy water and a scrubber which will eliminate even cigarette burns. The durable and recoverable nature make this is an eco-compatible material.

Duradero y recuperable: material que puede recuperar completamente su aspecto original utilizando simplemente detergentes y estropajos abrasivos para eliminar incluso las quemaduras de cigarrillo. Sus propiedades de duración y capacidad de recuperación lo convierten en un material eco-compatible.



The hidden click-clack drain valve can be easily open and close by pressing the cover.

Al presionar la tapa abrimos o cerramos la válvula automática oculta click-clack.



Optimum ultraviolet resistance: compact, non-porous, hygienic, resistant and pleasant to the touch thanks to the velvety finish, similar to natural stone.

Óptima resistencia a los rayos ultravioletas: es compacto, no poroso, higiénico, resistente y agradable al tacto gracias a su acabado aterciopelado, similar al de la piedra natural.

Highly fire resistant: the material is practically fireproof, with Class 1 fire resistance rating.

Alta resistencia al fuego: es prácticamente ignífugo, con certificado de resistencia al fuego Clase 1.



CODE / CODIFICACIÓN

779	121	003	AAA	AAA	MATTE STRUCTURE + MATTE FRONT CUERPO MATE + FRONTAL MATE
779	121	003	AAA	BBB	MATTE STRUCTURE + GLOSSY FRONT CUERPO MATE + FRONTAL BRILLO
COLLECTION COLECCIÓN	TYPE MODELO	STRUCTURE COLOUR COLOR CUERPO	DOOR COLOUR COLOR PUERTA		

FINISHES / ACABADOS

AAA

MATTE LACQUERED / LACADO MATE

STRUCTURE AND FRONT COLOUR
COLOR CUERPO Y FRONTAL

	102 MATTE WHITE BLANCO MATE		116 MATTE GREEN VERDE MATE
	104 MATTE LIGHT GREY GRIS CLARO MATE		126 MATTE BLUE AZUL MATE
	110 MATTE LIGHT CREAM CREMA LIGHT MATE		124 MATTE AUBERGINE BERENJENA MATE
	140 MATTE OLIVE GREY GRIS OLIVA MATE		122 MATTE PINK ROSA MATE
	112 MATTE MINK VISON MATE		120 MATTE RUBY RUBÍ MATE
	106 MATTE AMETHYST GREY GRIS AMATISTA MATE		118 MATTE ORANGE NARANJA MATE
	114 MATTE CHOCOLATE CHOCOLATE MATE		128 MATTE METALLIC GREY GRIS METALIZADO MATE
	108 MATTE BLACK NEGRO MATE		

BBB

GLOSSY LACQUERED / LACADO BRILLO

FRONT COLOUR
COLOR FRONTAL

	064 GLOSSY WHITE BLANCO BRILLO		115 GLOSSY GREEN VERDE BRILLO
	103 GLOSSY LIGHT GREY GRIS CLARO BRILLO		125 GLOSSY BLUE AZUL BRILLO
	109 GLOSSY LIGHT CREAM CREMA LIGHT BRILLO		123 GLOSSY AUBERGINE BERENJENA BRILLO
	139 GLOSSY OLIVE GREY GRIS OLIVA BRILLO		121 GLOSSY PINK ROSA BRILLO
	111 GLOSSY MINK VISON BRILLO		119 GLOSSY RUBY RUBÍ BRILLO
	105 GLOSSY AMETHYST GREY GRIS AMATISTA BRILLO		117 GLOSSY ORANGE NARANJA BRILLO
	113 GLOSSY CHOCOLATE CHOCOLATE BRILLO		127 GLOSSY METALLIC GREY GRIS METALIZADO BRILLO
	034 GLOSSY BLACK NEGRO BRILLO		

THIS WASHBASIN CAN BE CUSTOM ORDERED WITHOUT A TAP HOLE.
 ESTE MUEBLE EXISTE, BAJO PEDIDO, SIN AGUJERO PARA GRIFERIA.



2 DRAWER CABINET WITH MATTE WASHBASIN
 MUEBLE 2 CAJONES CON LAVABO MATE

779 121 003 AAA AAA
 MATTE STRUCTURE + MATTE FRONT
 CUERPO MATE + FRONTAL MATE

779 121 003 AAA BBB
 MATTE STRUCTURE + GLOSSY FRONT
 CUERPO MATE + FRONTAL BRILLO

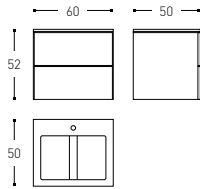

INCH 23.62x19.69x20.47



2 DRAWER CABINET WITH MATTE WASHBASIN
 MUEBLE 2 CAJONES CON LAVABO MATE

779 121 403 AAA AAA
 MATTE STRUCTURE + MATTE FRONT
 CUERPO MATE + FRONTAL MATE

779 121 403 AAA BBB
 MATTE STRUCTURE + GLOSSY FRONT
 CUERPO MATE + FRONTAL BRILLO

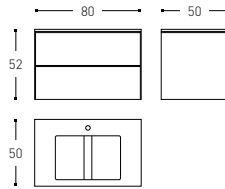

INCH 31.5x19.69x20.47



2 DRAWER CABINET WITH MATTE WASHBASIN
 MUEBLE 2 CAJONES CON LAVABO MATE

779 121 803 AAA AAA
 MATTE STRUCTURE + MATTE FRONT
 CUERPO MATE + FRONTAL MATE

779 121 803 AAA BBB
 MATTE STRUCTURE + GLOSSY FRONT
 CUERPO MATE + FRONTAL BRILLO

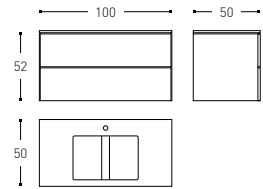

INCH 39.37x19.69x20.47



4 DRAWER CABINET WITH 2 SINK MATTE WASHBASIN
 MUEBLE 4 CAJONES CON LAVABO MATE 2 SENOS

779 122 205 AAA AAA
 MATTE STRUCTURE + MATTE FRONT
 CUERPO MATE + FRONTAL MATE

779 122 205 AAA BBB
 MATTE STRUCTURE + GLOSSY FRONT
 CUERPO MATE + FRONTAL BRILLO

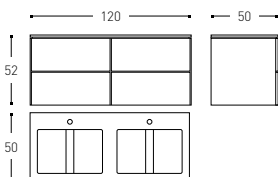

INCH 47.24x19.69x20.47



4 DRAWER CABINET WITH RIGHT MATTE WASHBASIN SINK
 MUEBLE 4 CAJONES CON LAVABO MATE SENO DERECHA

779 122 215 AAA AAA
 MATTE STRUCTURE + MATTE FRONT
 CUERPO MATE + FRONTAL MATE

779 122 215 AAA BBB
 MATTE STRUCTURE + GLOSSY FRONT
 CUERPO MATE + FRONTAL BRILLO

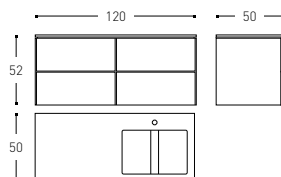

INCH 47.24x19.69x20.47



4 DRAWER CABINET WITH LEFT MATTE WASHBASIN SINK
 MUEBLE 4 CAJONES CON LAVABO MATE SENO IZQUIERDA

779 122 225 AAA AAA
 MATTE STRUCTURE + MATTE FRONT
 CUERPO MATE + FRONTAL MATE

779 122 225 AAA BBB
 MATTE STRUCTURE + GLOSSY FRONT
 CUERPO MATE + FRONTAL BRILLO

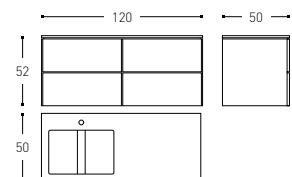

INCH 47.24x19.69x20.47





4 DRAWER CABINET WHIT 2 SINK MATTE WASHBASIN
MUEBLE 4 CAJONES CON LAVABO MATE 2 SENOS

779 123 005 AAA AAA
MATTE STRUCTURE + MATTE FRONT
CUERPO MATE + FRONTAL MATE

779 123 005 AAA BBB
MATTE STRUCTURE + GLOSSY FRONT
CUERPO MATE + FRONTAL BRILLO

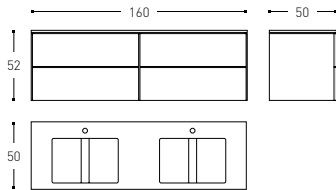

4 DRAWER CABINET WITH RIGHT MATTE WASHBASIN SINK
MUEBLE 4 CAJONES CON LAVABO MATE SENO DERECHA

779 123 015 AAA AAA
MATTE STRUCTURE + MATTE FRONT
CUERPO MATE + FRONTAL MATE

779 123 015 AAA BBB
MATTE STRUCTURE + GLOSSY FRONT
CUERPO MATE + FRONTAL BRILLO

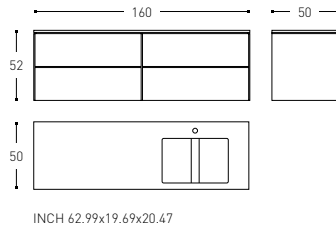

4 DRAWER CABINET WITH LEFT MATTE WASHBASIN SINK
MUEBLE 4 CAJONES CON LAVABO MATE SENO IZQUIERDA

779 123 025 AAA AAA
MATTE STRUCTURE + MATTE FRONT
CUERPO MATE + FRONTAL MATE

779 123 025 AAA BBB
MATTE STRUCTURE + GLOSSY FRONT
CUERPO MATE + FRONTAL BRILLO

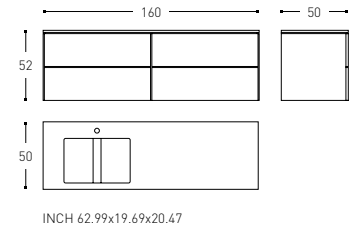

4 DRAWER CABINET WITH 2 SINK MATTE WASHBASIN
MUEBLE 4 CAJONES CON LAVABO MATE 2 SENOS

779 123 805 AAA AAA
MATTE STRUCTURE + MATTE FRONT
CUERPO MATE + FRONTAL MATE

779 123 805 AAA BBB
MATTE STRUCTURE + GLOSSY FRONT
CUERPO MATE + FRONTAL BRILLO

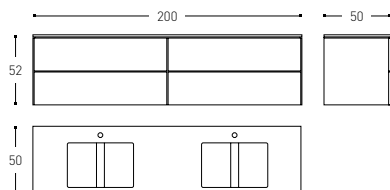

CABINET
ARMARIO

779 001 407 AAA AAA
MATTE STRUCTURE + MATTE FRONT
CUERPO MATE + FRONTAL MATE

779 001 407 AAA BBB
MATTE STRUCTURE + GLOSSY FRONT
CUERPO MATE + FRONTAL BRILLO

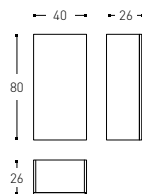

LEGS SET (X2)
CONJUNTO PIES (X2)

719 0199

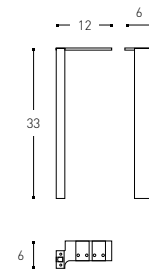

Spare parts | Recambios

TRAP WITH VALVE
SIFÓN CON VÁLVULA

3419151

SPARE PART OF / RECAMBIO DE
**779121003AAABBB, 779121403AAABBB, 779121803AAABBB,
779122205AAABBB, 779122215AAABBB, 779122225AAABBB,
779123005AAABBB, 779123015AAABBB, 779123025AAABBB,
779123805AAABBB**

DRAIN COVER
TAPA DESAGÜE

3410297

MATTE WHITE-CHROME / BLANCO MATE-CROMO

SPARE PART OF / RECAMBIO DE

CLEANING SET
KIT DE LIMPIEZA

3410295

SPARE PART OF / RECAMBIO DE

REPAIRING KIT
KIT REPARACIÓN

3410296

SPARE PART OF / RECAMBIO DE

CABINET WITH WASHBASIN MOUNTING SET
ACCESORIO SUJECIÓN MUEBLE CON LAVABO

3419120

SPARE PART OF / RECAMBIO DE
**779121003AAABBB, 779122225AAABBB, 779122205AAABBB,
779122215AAABBB**

3419121

SPARE PART OF / RECAMBIO DE
**779121403AAABBB, 779123025AAABBB, 779123015AAABBB,
779123005AAABBB**

3419122

SPARE PART OF / RECAMBIO DE
779121803AAABBB, 779123805AAABBB

UPPER DRAWER FOR WASHBASIN CABINET
CAJÓN SUPERIOR MUEBLE PARA LAVABO

3410284

SPARE PART OF / RECAMBIO DE
779121003AAABBB, 779122205AAABBB, 779122225AAABBB, 779122215AAABBB

3410285

SPARE PART OF / RECAMBIO DE
**779121403AAABBB, 779123005AAABBB, 779123025AAABBB,
779125015AAABBB**

3410286

SPARE PART OF / RECAMBIO DE
779121803AAABBB, 779123805AAABBB

UPPER DRAWER FOR CABINET WITHOUT TOP
CAJÓN SUPERIOR MUEBLE SIN ENCIMERA

3410136

SPARE PART OF / RECAMBIO DE
779122215AAABBB, 779122225AAABBB

3410248

SPARE PART OF / RECAMBIO DE
779123015AAABBB, 779123025AAABBB

LOWER DRAWER
CAJÓN INFERIOR

3410131

SPARE PART OF / RECAMBIO DE
779121003AAABBB, 779122225AAABBB, 779122205AAABBB, 779122215AAABBB

3410133

SPARE PART OF / RECAMBIO DE
**779121403AAABBB, 779123025AAABBB, 779123015AAABBB,
779123005AAABBB**

3410135

SPARE PART OF / RECAMBIO DE
779121803AAABBB, 779123805AAABBB

UPPER/LOWER DRAWER FOR CABINET & LOWER FOR CABINET WITHOUT TOP
CAJÓN SUP./INF. MUEBLE Y INF. MUEBLE SIN ENCIMERA

3410137

SPARE PART OF / RECAMBIO DE
779122215AAABBB, 779122225AAABBB

3410249

SPARE PART OF / RECAMBIO DE
779123015AAABBB, 779123025AAABBB

RAIL SYSTEM SET FOR CABINET WITH BASIN 60/80/100CM
JUEGO DE GUÍAS MUEBLE LAVABO 60/80/100CM

3410138

SPARE PART OF / RECAMBIO DE
**779121003AAABBB, 779121403AAABBB, 779121803AAABBB,
779122205AAABBB, 779123005AAABBB, 779123805AAABBB,
779122215AAABBB, 779122225AAABBB, 779129015AAABBB, 779123025AAABBB**

RAIL SYSTEM SET + CABINET WITHOUT TOP 60CM
JUEGO GUÍAS MUEBLE + MUEBLE SIN ENCIMERA 60CM

3410139

SPARE PART OF / RECAMBIO DE
779122215AAABBB, 779122225AAABBB, 779123025AAABBB, 779123015AAABBB

FRONT PART 60CM 2 U.
FRONTAL 60CM 2 U.

77999001BBB

MATTE / MATE

SPARE PART OF / RECAMBIO DE
779121003AAABBB, 779122205AAABBB, 779122215AAABBB, 779122225AAABBB

77999001BBB

GLOSSY / BRILLO

SPARE PART OF / RECAMBIO DE
779121003AAABBB, 779122205AAABBB, 779122215AAABBB, 779122225AAABBB

FRONT PART 80CM 2 U.
FRONTAL 80CM 2 U.

77999002BBB

MATTE / MATE

SPARE PART OF / RECAMBIO DE
**779121403AAABBB, 779123005AAABBB, 779123015AAABBB,
779123025AAABBB**

77999002BBB

GLOSSY / BRILLO

SPARE PART OF / RECAMBIO DE
**779121403AAABBB, 779123005AAABBB, 779123015AAABBB,
779123025AAABBB**



FRONT PART 100CM 2 U.
FRONTAL 100CM 2 U.

77999003BBB

MATTE / MATE

SPARE PART OF / RECAMBIO DE
779121803AAABBB, 779123805AAABBB

77999003BBB

GLOSSY / BRILLO

SPARE PART OF / RECAMBIO DE
779121803AAABBB, 779123805AAABBB

STRAIGHT DIVIDER
SEPARADOR RECTO

3419011

SPARE PART OF / RECAMBIO DE
**7791210003AAABBB, 779121403AAABBB, 779121803AAABBB,
779122205AAABBB, 779122215AAABBB, 779122225AAABBB,
779123005AAABBB, 779123015AAABBB, 779123025AAABBB,
779123805AAABBB**

RIGHT ANGLE DIVIDER
SEPARADOR CURVO

3419014

SPARE PART OF / RECAMBIO DE
**779121003AAAABBB, 779121403AAABBB, 779121803AAABBB,
779122205AAABBB, 779122215AAABBB, 779122225AAABBB,
779123005AAABBB, 779123015AAABBB, 779123025AAABBB,
779123805AAABBB**

HIGH BASKET
CONTAINER ALTO

3419015

SMOKED / FUME

SPARE PART OF / RECAMBIO DE
**779121003AAAABBB, 779121403AAABBB, 779121803AAABBB,
779122205AAABBB, 779122215AAABBB, 779122225AAABBB,
779123005AAABBB, 779123015AAABBB, 779123025AAABBB,
779123805AAABBB**

CABINET MOUNTING SET
ACCESORIO SUJECIÓN ARMARIO

3419119

SPARE PART OF / RECAMBIO DE
779001407AAABBB

HINGE CABINET
BISAGRA ARMARIO

3419101

SPARE PART OF / RECAMBIO DE
779001407AAABBB

CABINET DOOR
PUERTA ARMARIO

77999004BBB

MATTE / MATE

SPARE PART OF / RECAMBIO DE
779001407AAABBB

77999004BBB

GLOSSY / BRILLO

SPARE PART OF / RECAMBIO DE
779001407AAABBB



Block Evo

Design by **Cosmic Studio**







719 02 1403 102 102
2 DRAWER CABINET & GLOSSY TECKSTONE WASHBASIN
MUEBLE 2 CAJONES LAVABO TECKSTONE BRILLO
(80,5X50X58)



Block Evo is the perfect balance between design and price. It offers what you expect: iconic design, maximal functionality and easy maintenance. This is Block Evo, the new version of Block, open to all.

Block Evo es el equilibrio perfecto entre diseño y precio. Ofrece todo aquello que esperas: diseño icónico, máxima funcionalidad y fácil mantenimiento. Esto es Block Evo, la nueva versión de Block accesible a todos.







719 00 1407 139 139
CABINET
ARMARIO
(35X20X77,5)

719 01 1803 139 139
2 DRAWER CABINET & MATTE TECKSTONE WASHBASIN
MUEBLE 2 CAJONES LAVABO TECKSTONE MATE
(100,5X50X58)

719 00 2808 139 139
CABINET
ARMARIO
(35X20X155)







719 01 1803 139 139
2 DRAWER CABINET & MATTE TECKSTONE WASHBASIN
MUEBLE 2 CAJONES LAVABO TECKSTONE MATE
(100,5X50X58)

719 00 1407 139 139
CABINET
ARMARIO
(35X20X77,5)











719 02 1403 177 177
2 DRAWER CABINET & GLOSSY TECKSTONE WASHBASIN
MUEBLE 2 CAJONES LAVABO TECKSTONE BRILLO
(80,5X50X58)

719 00 2808 177 177
CABINET
ARMARIO
(35X20X155)





719 02 1003 176 176
2 DRAWER CABINET & GLOSSY TECKSTONE WASHBASIN
MUEBLE 2 CAJONES LAVABO TECKSTONE BRILLO
(60,5X50X58)

719 00 2808 176 176
CABINET
ARMARIO
(35X20X155)





The drawers, with an integrated handle in the side, are completely removable to let the most pleasant use.

Los cajones, con tirador integrado en el lateral, se extraen totalmente permitiendo un uso más cómodo.



Leg set (optional).

Pies opcionales.

Hidden self & soft close with new rail system which can be completely removed. The long lasting durability of drawers is assured by quality control tests (up to 20,000 cycles).

Apertura y cierre amortiguado con nuevas guías de extracción total ocultas soft & self close. La durabilidad de los cajones está asegurada ya que han superado con éxito hasta 20.000 ciclos en los test de control de calidad.



Best use of storage space thanks to the depth of the drawers. Inner drawers of anthracite colors. Divided container which can be shifted to let the most suitable use of personal space.

Optimización del espacio gracias a una mayor profundidad de los cajones. Interiores de color antracita, con un separador móvil que permite una organización del espacio personal.



Lacquered and high quality laminate finishes. High resistance to abrasion, waterproof and easy maintenance. Colours unalterable.

Acabados lacados y laminados de alta gama. Gran resistencia a la abrasión, impermeables y de fácil limpieza. Los tonos se mantienen inalterables a lo largo del tiempo.



Eco friendly: furniture made in Spain with certified wood board (PEFC/FSC) following the chain of custody in forestry.

Producto ambientalmente responsable: muebles fabricados en España con tableros de madera certificada (PEFC/FSC) conforme la cadena de custodia de productos forestales.



TECKSTONE

5
YEARS
GUARANTEE
AÑOS
GARANTÍA

Washbasins made of Teckstone, advanced formula composed of natural minerals (calcium carbonate and quartz) mixed with resin and covered by a Gelcoat Premium Maxguard. High resistance to UVA rays and attack of chemical products.

Lavabos de Teckstone, formulación avanzada compuesta de minerales naturales (carbonato de calcio y cuarzo) mezclados con resina y recubiertos con una película Gelcoat Premium Maxguard. Alta resistencia a los rayos UVA y ataque de productos químicos.



Long or short cabinet with fumed glass shelves.

Armario alto o bajo con estantes en cristal "fumé".

The hidden click-clack drain valve can be easily open and close by pressing the cover.

Al presionar la tapa abrimos o cerramos la válvula automática oculta click-clack.



It gives the possibility to adding built-in plugs.

Posibilidad de incorporar enchufes en el interior.

Block Evo has successfully passed the high demanding tests of long last durability and resistance to extreme uses (static charge or impact testing) to assure long last durability of the product.

Toda la gama **Block Evo** ha superado con éxito exigentes tests de durabilidad y resistencia a usos extremos (cargas estáticas o test de impacto), para asegurar una larga vida al producto.



Block Evo

Design by Cosmic Studio



CODE / CODIFICACIÓN

719	AA	1003	BBB	BBB	TECHNICALS TÉCNICOS
719	AA	1003	CCC	CCC	MATTE LACQUERED LACADO MATE
719	AA	1003	DDD	DDD	GLOSSY LACQUERED LACADO BRILLO

COLLECTION
COLECCIÓN

WASHBASIN
LAVABO

TYPE
MODELO

STRUCTURE AND DOOR COLOUR
COLOR CUERPO Y PUERTA

FINISHES / ACABADOS

AA

WASHBASIN / LAVABO



01
MATTE
MATE



02
GLOSSY
BRILLO

BBB BBB

TECHNICALS / TÉCNICOS

STRUCTURE AND DOOR / CUERPO Y PUERTA

WOOD FINISHES
ACABADOS EN MADERA



175 175
OAK PATINA WHITE
ROBLE PATINADO BLANCO



176 176
GREYISH OAK
ROBLE GRISACEO



177 177
MOKA OAK
ROBLE MOKA

CCC CCC

MATTE LACQUERED / LACADO MATE

STRUCTURE AND DOOR / CUERPO Y PUERTA

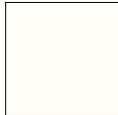

102 102
MATE WHITE
BLANCO MATE

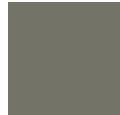

116 116
MATE GREEN
VERDE MATE

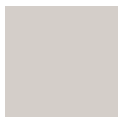

104 104
MATE LIGHT GREY
GRIS CLARO MATE



126 126
MATE BLUE
AZUL MATE



110 110
MATE LIGHT CREAM
CREMA LIGHT MATE



124 124
MATE AUBERGINE
BERENJENA MATE



140 140
MATE OLIVE GREY
GRIS OLIVA MATE



122 122
MATE PINK
ROSA MATE



112 112
MATE MINK
VISON MATE



120 120
MATE RUBY
RUBÍ MATE



106 106
MATE AMETHYST
GREY
GRIS AMATISTA MATE



118 118
MATE ORANGE
NARANJA MATE



114 114
MATE CHOCOLATE
CHOCOLATE MATE



128 128
MATE METALLIC GREY
GRIS METALIZADO
MATE



108 108
MATE BLACK
NEGRO MATE

DDD DDD

GLOSSY LACQUERED / LACADO BRILLO

STRUCTURE AND DOOR / CUERPO Y PUERTA



064 064
GLOSSY WHITE
BLANCO BRILLO



115 115
GLOSSY GREEN
VERDE BRILLO



103 103
GLOSSY LIGHT GREY
GRIS CLARO BRILLO



125 125
GLOSSY BLUE
AZUL BRILLO



109 109
GLOSSY LIGHT CREAM
CREMA LIGHT BRILLO



123 123
GLOSSY AUBERGINE
BERENJENA BRILLO



139 139
GLOSSY OLIVE GREY
GRIS OLIVA BRILLO



121 121
GLOSSY PINK
ROSA BRILLO



111 111
GLOSSY MINK
VISON BRILLO



119 119
GLOSSY RUBY
RUBÍ BRILLO



105 105
GLOSSY AMETHYST
GREY
GRIS AMATISTA
BRILLO



117 117
GLOSSY ORANGE
NARANJA BRILLO



113 113
GLOSSY CHOCOLATE
CHOCOLATE BRILLO



127 127
GLOSSY METALLIC
GREY
GRIS METALIZADO
BRILLO



034 034
GLOSSY BLACK
NEGRO BRILLO



Block Evo

Design by Cosmic Studio



2 DRAWER CABINET & TECKSTONE WASHBASIN
MUEBLE 2 CAJONES LAVABO TECKSTONE

719 AA 1003 BBB BBB
TECHNICALS / TÉCNICOS
719 AA 1003 CCC CCC
MATTE LACQUERED / LACADO MATE
719 AA 1003 DDD DDD
GLOSSY LACQUERED / LACADO BRILLO

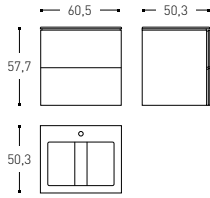

INCH 23.8x19.8x22.7



2 DRAWER CABINET & TECKSTONE WASHBASIN
MUEBLE 2 CAJONES LAVABO TECKSTONE

719 AA 1403 BBB BBB
TECHNICALS / TÉCNICOS
719 AA 1403 CCC CCC
MATTE LACQUERED / LACADO MATE
719 AA 1403 DDD DDD
GLOSSY LACQUERED / LACADO BRILLO

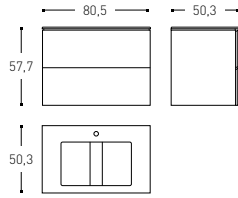

INCH 31.7x19.8x22.7



2 DRAWER CABINET & TECKSTONE WASHBASIN
MUEBLE 2 CAJONES LAVABO TECKSTONE

719 AA 1803 BBB BBB
TECHNICALS / TÉCNICOS
719 AA 1803 CCC CCC
MATTE LACQUERED / LACADO MATE
719 AA 1803 DDD DDD
GLOSSY LACQUERED / LACADO BRILLO

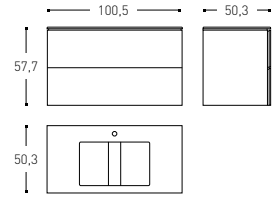

INCH 39.6x19.8x22.7



LEGS SET (X2)
CONJUNTO PIES (X2)

719 0198
GLOSSY CHROME / CROMO BRILLO

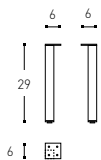

INCH 2.4x2.4x11.4



SOCKET
ENCHUFE

719 0096

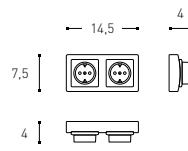

INCH 5.7x1.6x2.9



CONTAINER
CONTAINER

341 9015
SMOKED/FUMÉ

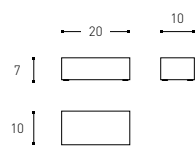

INCH 7.9x3.9x2.7



■ ■
CABINET
ARMARIO

719 00 2808 BBB BBB
TECHNICALS / TÉCNICOS
719 00 2808 CCC CCC
MATTE LACQUERED / LACADO MATE
719 00 2808 DDD DDD
GLOSSY LACQUERED / LACADO BRILLO

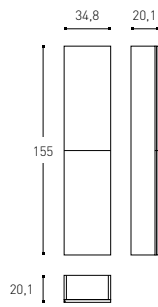

INCH 13.7x7.9x61



■ ■
CABINET
ARMARIO

719 00 1407 BBB BBB
TECHNICALS / TÉCNICOS
719 00 1407 CCC CCC
MATTE LACQUERED / LACADO MATE
719 00 1407 DDD DDD
GLOSSY LACQUERED / LACADO BRILLO

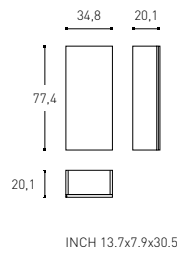

INCH 13.7x7.9x30.5



Block Evo

Design by **Cosmic Studio**

TRAP WITH VALVE
SIFÓN CON VÁLVULA

3419151

SPARE PART OF / RECAMBIO DE
719AA1003BBBBBB, 719AA1403BBBBBB, 719AA1803BBBBBB

DRAIN COVER
TAPA DESAGÜE

3419406

GLOSSY WHITE / BLANCO BRILLO

SPARE PART OF / RECAMBIO DE
719021003BBBBBB, 719021403BBBBBB, 719021803BBBBBB

3419407

WHITE-MATTE / BLANCO-MATE

SPARE PART OF / RECAMBIO DE
719011003BBBBBB, 719011403BBBBBB, 719011803BBBBBB

OVERFLOW ESCUTCHEON
EMBELLECEDOR REBOSASERO

3419152

CHROME / CROMO

SPARE PART OF / RECAMBIO DE
719AA1003BBBBBB, 719AA1403BBBBBB, 719AA1803BBBBBB

3419153

GLOSSY WHITE / BLANCO BRILLO

SPARE PART OF / RECAMBIO DE
719AA1003BBBBBB, 719AA1403BBBBBB, 719AA1803BBBBBB

CABINET WITH WASHBASIN MOUNTING SET
ACCESORIO SUJECIÓN MUEBLE CON LAVABO

3410446

SPARE PART OF / RECAMBIO DE
719AA1003BBBBBB, 719AA1403BBBBBB, 719AA1803BBBBBB

UPPER DRAWER FOR WASHBASIN CABINET
CAJÓN SUPERIOR MUEBLE PARA LAVABO

3419140

SPARE PART OF / RECAMBIO DE
719AA1003BBBBBB

3419141

SPARE PART OF / RECAMBIO DE
719AA1403BBBBBB

3419142

SPARE PART OF / RECAMBIO DE
719AA1803BBBBBB

LOWER DRAWER
CAJÓN INFERIOR

3419143

SPARE PART OF / RECAMBIO DE
719AA1003BBBBBB

3419144

SPARE PART OF / RECAMBIO DE
719AA1403BBBBBB

3419145

SPARE PART OF / RECAMBIO DE
719AA1803BBBBBB

SET OF RAILS FOR FURNITURE WITH VANITY TOP
JUEGO GUÍAS MUEBLE CON ENCIMERA

3419148

SPARE PART OF / RECAMBIO DE
719AA1003BBBBBB, 719AA1403BBBBBB, 719AA1803BBBBBB

FIXING TRIGGER FOR RIGHT RAIL
GATILLO SUJECIÓN GUÍA DERECHA

3419149

SPARE PART OF / RECAMBIO DE
719AA1003BBBBBB, 719AA1403BBBBBB, 719AA1803BBBBBB

FIXING TRIGGER FOR LEFT RAIL
GATILLO SUJECIÓN GUÍA IZQUIERDA

3419150

SPARE PART OF / RECAMBIO DE
719AA1003BBBBBB, 719AA1403BBBBBB, 719AA1803BBBBBB

SUBJECTION SQUARE
ESCUADRA

3419146

SPARE PART OF / RECAMBIO DE
719AA1003BBBBBB, 719AA1403BBBBBB, 719AA1803BBBBBB

UPPER FRONT PART (60CM)
FRONTAL SUPERIOR (60CM)

71999002BBB

TECHNICAL / TÉCNICO

SPARE PART OF / RECAMBIO DE
719AA1003BBBBBB

71999002BBB

MATTE / MATE

SPARE PART OF / RECAMBIO DE
719AA1003BBBBBB

71999002BBB

GLOSSY / BRILLO

SPARE PART OF / RECAMBIO DE
719AA1003BBBBBB

UPPER FRONT PART (80CM)
FRONTAL SUPERIOR (80CM)

71999004BBB

TECHNICAL / TÉCNICO

SPARE PART OF / RECAMBIO DE
719AA1403BBBBBB

71999004BBB

MATTE / MATE

SPARE PART OF / RECAMBIO DE
719AA1403BBBBBB

71999004BBB

GLOSSY / BRILLO

SPARE PART OF / RECAMBIO DE
719AA1403BBBBBB

UPPER FRONT PART (100CM)
FRONTAL SUPERIOR (100CM)

71999006BBB

TECHNICAL / TÉCNICO

SPARE PART OF / RECAMBIO DE
719AA1803BBBBBB

71999006BBB

MATTE / MATE

SPARE PART OF / RECAMBIO DE
719AA1803BBBBBB

71999006BBB

GLOSSY / BRILLO

SPARE PART OF / RECAMBIO DE
719AA1803BBBBBB

Spare parts | Recambios

LOWER FRONT PART (60CM)
FRONTAL INFERIOR (60CM)

71999003BBB

TECHNICAL / TÉCNICO

SPARE PART OF / RECAMBIO DE
719AA1003BBBBBB

71999003BBB

MATTE / MATE

SPARE PART OF / RECAMBIO DE
719AA1003BBBBBB

71999003BBB

GLOSSY / BRILLO

SPARE PART OF / RECAMBIO DE
719AA1003BBBBBB

LOWER FRONT PART (80CM)
FRONTAL INFERIOR (80CM)

71999005BBB

TECHNICAL / TÉCNICO

SPARE PART OF / RECAMBIO DE
719AA1403BBBBBB

71999005BBB

MATTE / MATE

SPARE PART OF / RECAMBIO DE
719AA1403BBBBBB

71999005BBB

GLOSSY / BRILLO

SPARE PART OF / RECAMBIO DE
719AA1403BBBBBB

LOWER FRONT PART (100CM)
FRONTAL INFERIOR (100CM)

71999007BBB

TECHNICAL / TÉCNICO

SPARE PART OF / RECAMBIO DE
719AA1803BBBBBB

71999007BBB

MATTE / MATE

SPARE PART OF / RECAMBIO DE
719AA1803BBBBBB

71999007BBB

GLOSSY / BRILLO

SPARE PART OF / RECAMBIO DE
719AA1803BBBBBB

DRAWER DIVIDERS
SEPARADOR CAJÓN

3419139

SPARE PART OF / RECAMBIO DE
719AA1003BBBBBB, 719AA1403BBBBBB, 719AA1803BBBBBB

CABINET MOUNTING SET
ACCESORIO SUJECIÓN ARMARIO

3410441

SPARE PART OF / RECAMBIO DE
719002808BBBBBB, 719001407BBBBBB

CABINET SHELF HOLDER
SOPORTE ESTANTE ARMARIO

3419408

SPARE PART OF / RECAMBIO DE
719002808BBBBBB, 719001407BBBBBB

GLASS SHELF
ESTANTE VIDRIO

3419147

SPARE PART OF / RECAMBIO DE
719002808BBBBBB, 719001407BBBBBB

DOOR
PUERTA

71999001BBB

TECHNICAL / TÉCNICO

SPARE PART OF / RECAMBIO DE
719002808BBBBBB, 719001407BBBBBB

CABINET DOOR
PUERTA ARMARIO

71999001BBB

MATTE / MATE

SPARE PART OF / RECAMBIO DE
719002808BBBBBB, 719001407BBBBBB

71999001BBB

GLOSSY / BRILLO

SPARE PART OF / RECAMBIO DE
719002808BBBBBB, 719001407BBBBBB

HINGE CABINET
BISAGRA ARMARIO

3419409

SPARE PART OF / RECAMBIO DE
719001407BBBBBB, 719002808BBBBBB

DRYWALL ANCHOR
TACO PLADUR

3410637

SPARE PART OF / RECAMBIO DE
719AA1003BBBBBB, 719AA1403BBBBBB, 719AA1803BBBBBB, 719002808BBBBBB, 719001407BBBBBB



Container

Design by **Claramunt De Mas**









The reedition of the original collection with fine materials creates elegant and unique environments.

La reedición de la colección original con materiales nobles permite crear espacios elegantes y únicos.

775 06 10
WASHBASIN
LAVABO
(57X57X12,5 CM)

775 02 99
LEGS
PATAS
(100X3,2X77,5 CM)

775 80 15
TROLLEY
CARRO
(50X38,4X66,1 CM)











775 85 25
REVOLVING MIRROR + TOWEL RACK SHELF + HOOK
ESPEJO GIRATORIO + TOALLERO ESTANTE + COLGADOR
(57,5X37,6X198,6 CM)



775 85 23
REVOLVING MIRROR + 4 TOWEL RACKS SHELF
ESPEJO GIRATORIO + 4 TOALLEROS ESTANTE
(57,5X37,6X198,6 CM)



The washbasin stands on stainless steel legs in a glossy finish, offering towel rack function.

El lavabo descansa sobre unas patas de acero inoxidable en acabado brillo, que ofrecen la función de toallero.

The washbasin follows the original shape and design faithfully. A piece that combines the latest CNC (computer numerical control) technology with the most exclusive materials: Carrara, Marquina and Brescia marble (matte and glossy finish).

El lavabo es fiel a la forma y al diseño original. Una pieza que combina la última tecnología CNC (control numérico) con los materiales mas exclusivos Mármol Carrara, Marquina y Brescia (en mate y brillo).



Special hook for bathrobes.

Colgador especial para albornoces.



The revolving mirror measuring 1.90 m high, it allows for a full length view. The angle at which it turns means that shelving for box containers can be hidden from view behind it.

Espejo giratorio de 1,90 m, posibilita que una persona se refleje totalmente. El ángulo de giro permite esconder detrás de él estantes donde depositar cajas-container.



Eco friendly: furniture made in Spain with certified wood board (PEFC/FSC) following the chain of custody in forestry.

Producto ambientalmente responsable: muebles fabricados en España con tableros de madera certificada (PEFC/FSC) conforme la cadena de custodia de productos forestales.



Trolley, bench, stool, containers and tray made in moisture resistant MDF with a natural wood veneer, protected by an ecological 100% water-based varnish with anti-glare properties, which creates a matte finish.

Carro, banqueta y taburete, contenedores y bandeja fabricados con MDF hidrófugo con chapa de madera natural, protegida con barniz ecológico 100% al agua, con propiedades antireflectantes, que le confiere un acabado mate.

MARBLE | **5**
YEARS
GUARANTEE
AÑOS
GARANTÍA

Container has successfully passed the high demanding tests of long last durability and resistance to extreme uses (static charge or impact testing) to assure long last durability of the product.

Toda la gama **Container** ha superado con éxito exigentes tests de durabilidad y resistencia a usos extremos (cargas estáticas o test de impacto), para asegurar una larga vida al producto.



CODE / CODIFICACIÓN

775 AA 10 CARRARA

775 BB 10 MARQUINA-BRECCIA

COLLECTION
COLECCIÓN

WASHBASIN
LAVABO

TYPE
MODELO

AA

WASHBASIN / LAVABO

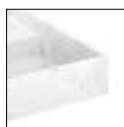

05
MATTE CARRARA
CARRARA MATE



15
GLOSSY CARRARA
CARRARA BRILLO

BB

WASHBASIN / LAVABO



06
MATTE MARQUINA
MARQUINA MATE



16
GLOSSY MARQUINA
MARQUINA BRILLO



08
MATTE BRECCIA
BRECCIA MATE



18
GLOSSY BRECCIA
BRECCIA BRILLO

CODE / CODIFICACIÓN

775 CC 23

COLLECTION
COLECCIÓN

FINISHES
ACABADOS

TYPE
MODELO

CC

FURNITURE / MUEBLES

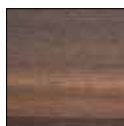

80
ANCIENT OAK
ROBLE MILENARIO



85
CANADIAN OAK
ROBLE CANADIENSE



⊙
COUNTERTOP WASHBASIN
 LAVABO ENCIMERA

775 AA 10
 CARRARA
775 BB 10
 MARGUINA-BRECCIA

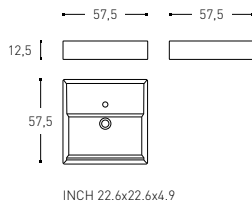

⊙ ⊙
LEGS
 PATAS

775 02 99

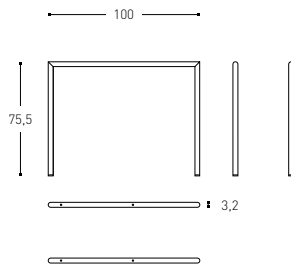

INCH 39.4x29.7



◆ ◻ ⊙ ⊙

REVOLVING MIRROR + 4 TOWEL RACKS SHELF
 ESPEJO GIRATORIO + 4 TOALLEROS ESTANTE

775 CC 23 *

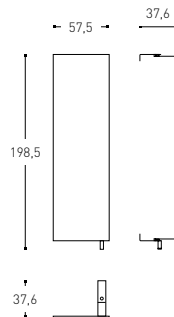

INCH 22.6x14.8x78.1

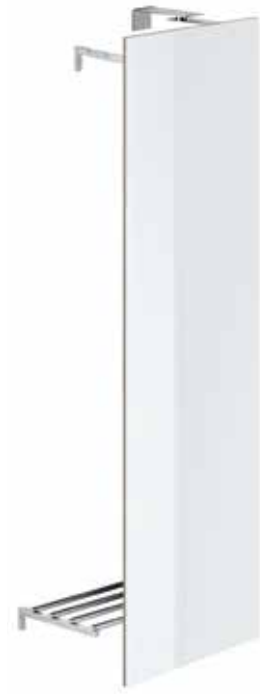

◆ ◻ ⊙ ⊙

REVOLVING MIRROR + TOWEL RACK SHELF + HOOK
 ESPEJO GIRATORIO + TOALLERO ESTANTE + COLGADOR

775 CC 25

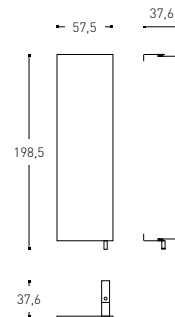

INCH 22.6x14.8x78.1

* 1 BIG BASKET AND 1 SMALL BASKET INCLUDED
 * 1 CONTAINER GRANDE Y 1 CONTAINER PEQUEÑO INCLUIDOS



Container

Design by Claramunt De Mas



☐
TROLLEY
CARRO

775 CC 15*

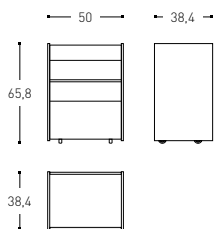

INCH 19.7x15.1x25.9



☐
BIG BASKET
CONTAINER GRANDE

775 CC 49

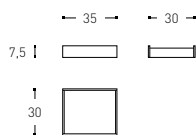

INCH 13.8x11.8x2.9



☐
SMALL BASKET
CONTAINER PEQUEÑO

775 CC 48

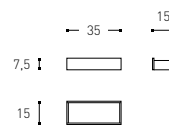

INCH 13.8x5.9x2.9

* 1 BIG BASKET AND 1 SMALL BASKET INCLUDED

* 1 CONTAINER GRANDE Y 1 CONTAINER PEQUEÑO INCLUIDOS



☐○
STOOL
BANQUETA

775 CC 07

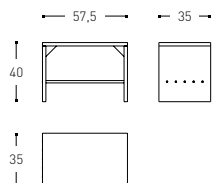

INCH 22.6x13.8x15.7



☐
STOOL
TABURETE

775 CC 06

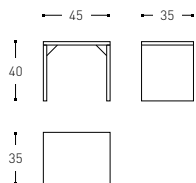

INCH 17.7x13.8x15.7



☐
SHELF
ESTANTE

775 CC 46

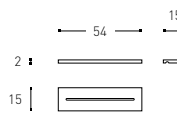

INCH 21.2x5.9x0.8



○
SHELF 50 CM
ESTANTE 50 CM

775 02 60

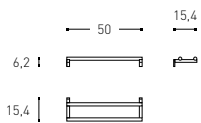

INCH 19.7x6.1x2.4



○
SHELF 100 CM
ESTANTE 100 CM

775 02 70

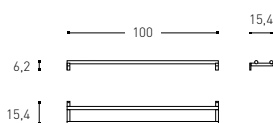

INCH 39.4x6.1x2.4



○
TOWEL BAR 50 CM
TOALLERO 50 CM

775 02 65

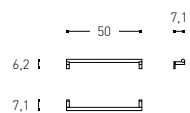

INCH 19.7x2.8x2.4



○
TOWEL BAR 100 CM
TOALLERO 100 CM

775 02 66

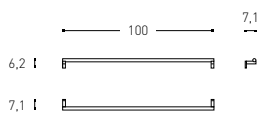

INCH 39.3x2.8x2.4



○
HOOK
COLGADOR

775 02 21

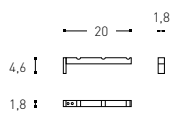

INCH 7.9x0.7x1.8



○
TOWEL RACK SHELF
TOALLERO ESTANTE

775 02 68

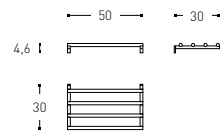

INCH 19.7x11.8x1.8

Container

Design by **Claramunt De Mas**



FREE DRAIN VALVE
VÁLVULA DESCARGA LIBRE

340 76 00
CHROME / CROMO

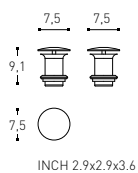

Spare parts | Recambios

SCREW MOUNTING SET (M5/M6)
JUEGO BIS SUJECIÓN (M5/M6)

3309100

SPARE PART OF / RECAMBIO DE
7750221, 7750260, 7750265, 7750266, 7750268, 7750270

BASIC MOUNTING SET
ACCESORIO SUJECIÓN BÁSICO

3410018

SPARE PART OF / RECAMBIO DE
7750221, 7750260, 7750265, 7750266, 7750268, 7750270

MOUNTING SET
ACCESORIO SUJECIÓN

3410653

SPARE PART OF / RECAMBIO DE
7750299, 7758023, 7758523, 7758025, 7758525

TRAP
SIFÓN

3410590

CHROME / CROMO

SPARE PART OF / RECAMBIO DE
755XX10

EXTENSION PIPE
TUBO ALARGO CROMO

2900113

CHROME / CROMO

SPARE PART OF / RECAMBIO DE
755XX10



Global Container

Design by **Claramunt De Mas**

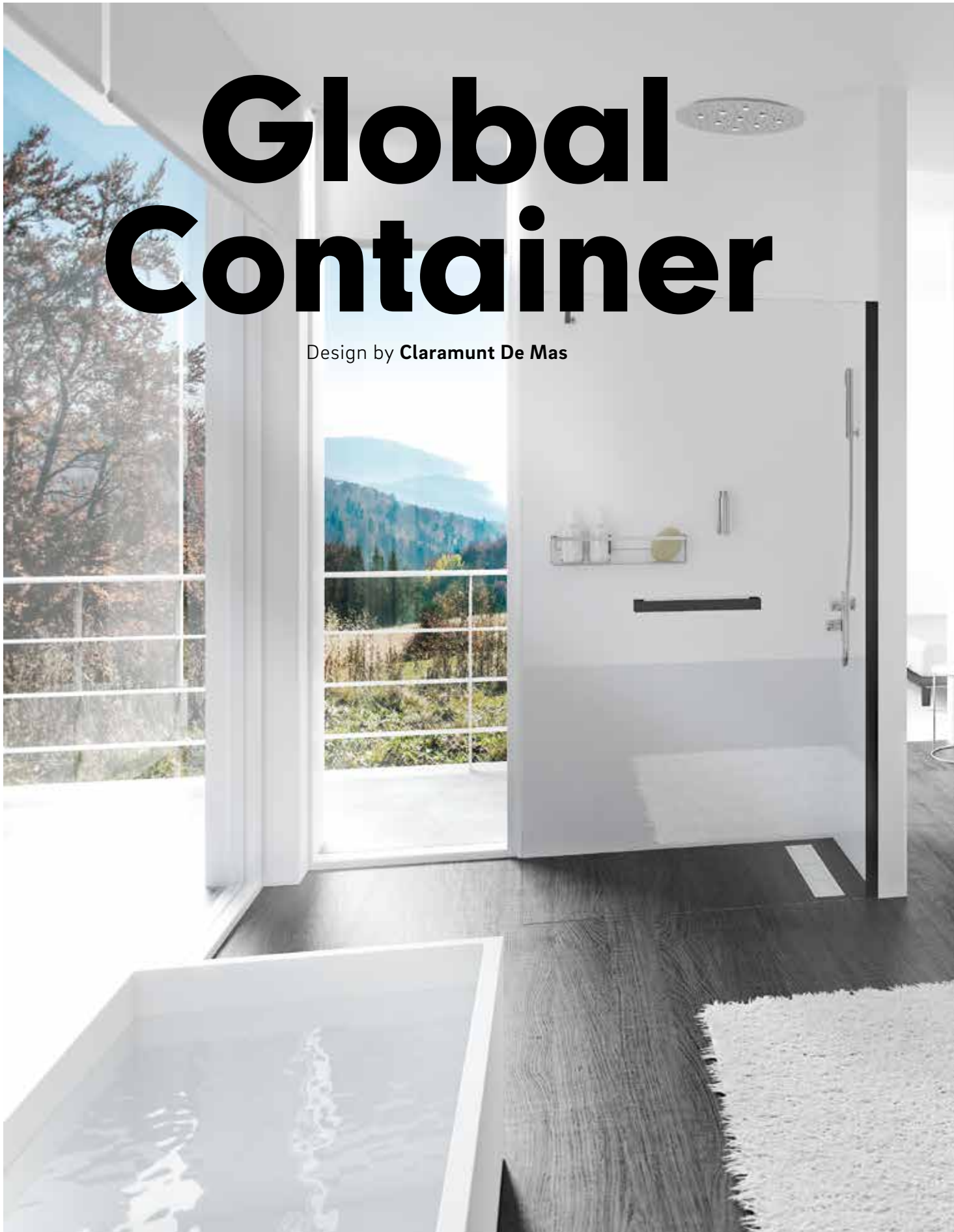





Simple lines and innovative concepts
reveal an ultracontemporary collection.

Una colección ultra contemporánea
por sus líneas básicas y conceptos
innovadores.



755 01 64
TOWEL RACK
TOALLERO
(15 CM)

755 05 10
WASHBASIN
LAVABO
(55X55X13 CM)

755 89 03
SLIDING MIRROR
ESPEJO CORREDERO
(100 CM)

755 00 0902 102 102
1 DRAWER CABINET
MUEBLE 1 CAJÓN
(55X50 CM)











755 00 1302 126 126
1 DRAWER CABINET
MUEBLE 1 CAJÓN
(75X51X33 CM)

755 45 03
SLIDING MIRROR
ESPEJO CORREDERO
(100X12,5X85 CM)



Global Container

Design by Claramunt De Mas



Porcelain washbasin designed to be fitted to a wall, streamlined outline and large 55x55 cm dimensions.

Lavabo de porcelana diseñado para instalación a pared, de líneas depuradas y grandes dimensiones 55x55 cm.

Bowl-shaped basin which acts as a storage for water. The design itself encourages water savings in daily use. Basin overflow comprising four holes which function as a soap holder.

Seno en forma de bol, que sirve de depósito para almacenar el agua. El propio diseño fomenta el ahorro en las acciones cotidianas. Rebosadero de cuatro agujeros que tienen la función de jabonera.



Option to add a towel rack, a towel shelf or both.

Posibilidad de añadir un toallero, un toallero repisa o ambas opciones a la vez.

Large capacity drawer with two containers inside to facilitate storage.

Cajón de gran capacidad con dos containers en su interior que facilitan el almacenaje.



The drawer modules are suspended and can be placed where needed.

Los módulos de los cajones quedan suspendidos pudiendo ser colocados donde se necesite.



Eco friendly: furniture made in Spain with certified wood board (PEFC/FSC) following the chain of custody in forestry. Lacquered finishing high quality. Colours unalterable.

Producto ambientalmente responsable: muebles fabricados en España con tableros de madera certificada (PEFC/FSC) conforme la cadena de custodia de productos forestales. Acabados lacados de alta gama. Los tonos se mantienen inalterables a lo largo del tiempo.



Remote controlled applies with bi-LED technology, to regulate intensity and warmth.

Aplique con tecnología bi-LED, que incluye mando para regular la intensidad y calidez de la luz.

Shelving and mirror have combined together in this collection to become a "wall-less" dressing room with a mirror which slides through the shelves, hiding or revealing the items inside.

Estantes y espejo se han fusionado en esta colección convirtiéndose en un armario camerino sin "paredes" en el que el espejo desliza por los estantes ocultando o dejando al descubierto los objetos de uso diario.

PORCELAIN | **5 YEARS GUARANTEE**
AÑOS GARANTÍA

Global Container has successfully passed the high demanding tests of long last durability and resistance to extreme uses (static charge or impact testing) to assure long last durability of the product.

Toda la gama **Global Container** ha superado con éxito exigentes tests de durabilidad y resistencia a usos extremos (cargas estáticas o test de impacto), para asegurar una larga vida al producto.





CODE / CODIFICACIÓN

755 00 1302 AAA AAA
755 00 1302 BBB BBB

MATTE LACQUERED
LACADO MATE

GLOSSY LACQUERED
LACADO BRILLO

COLLECTION
COLECCIÓN

TYPE
MODELO

FINISHES
ACABADOS

FURNITURE / MUEBLES

AAA AAA

MATTE LACQUERED / LACADO MATE

STRUCTURE AND DOOR / CUERPO Y PUERTA

	102 102 MATE WHITE BLANCO MATE		116 116 MATTE GREEN VERDE MATE
	104 104 MATTE LIGHT GREY GRIS CLARO MATE		126 126 MATTE BLUE AZUL MATE
	110 110 MATTE LIGHT CREAM CREMA LIGHT MATE		124 124 MATTE AUBERGINE BERENJENA MATE
	140 140 MATTE OLIVE GREY GRIS OLIVA MATE		122 122 MATTE PINK ROSA MATE
	112 112 MATTE MINK VISON MATE		120 120 MATTE RUBY RUBI MATE
	106 106 MATTE AMETHYST GREY GRIS AMATISTA MATE		118 118 MATTE ORANGE NARANJA MATE
	114 114 MATTE CHOCOLATE CHOCOLATE MATE		128 128 MATTE METALLIC GREY GRIS METALIZADO MATE
	108 108 MATTE BLACK NEGRO MATE		

BBB BBB

GLOSSY LACQUERED / LACADO BRILLO

STRUCTURE AND DOOR / CUERPO Y PUERTA

	064 064 GLOSSY WHITE BLANCO BRILLO		115 115 GLOSSY GREEN VERDE BRILLO
	103 103 GLOSSY LIGHT GREY GRIS CLARO BRILLO		125 125 GLOSSY BLUE AZUL BRILLO
	109 109 GLOSSY LIGHT CREAM CREMA LIGHT BRILLO		123 123 GLOSSY AUBERGINE BERENJENA BRILLO
	139 139 GLOSSY OLIVE GREY GRIS OLIVA BRILLO		121 121 GLOSSY PINK ROSA BRILLO
	111 111 GLOSSY MINK VISON BRILLO		119 119 GLOSSY RUBY RUBI BRILLO
	105 105 GLOSSY AMETHYST GREY GRIS AMATISTA BRILLO		117 117 GLOSSY ORANGE NARANJA BRILLO
	113 113 GLOSSY CHOCOLATE CHOCOLATE BRILLO		127 127 GLOSSY METALLIC GREY GRIS METALIZADO BRILLO
	034 034 GLOSSY BLACK NEGRO BRILLO		



CODE / CODIFICACIÓN

755 CC 65

GLOSSY CHROME / MATTE INOX
CROMO BRILLO / INOX MATE

COLLECTION
COLECCIÓN

FINISHES
ACABADOS

TYPE
MODELO

TOWEL RACK / TOALLEROS

CC



01
GLOSSY CHROME
CROMO BRILLO



03
MATTE INOX
INOX MATE

CODE / CODIFICACIÓN

755 DD 01

WHITE / MATTE INOX / GLOSSY SILVER
BLANCO / INOX MATE / PLATA BRILLO

COLLECTION
COLECCIÓN

FINISHES
ACABADOS

TYPE
MODELO

SHELVES AND MIRRORS / ESTANTES Y ESPEJOS

DD

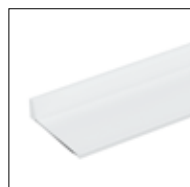

45
WHITE
BLANCO

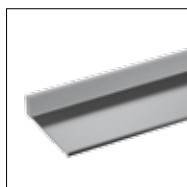

59
MATTE INOX
INOX MATE



89
GLOSSY SILVER
PLATA BRILLO

Global Container

Design by **Claramunt De Mas**



⊛
WASHBASIN + TRAP
 LAVABO + SIFÓN

755 05 10

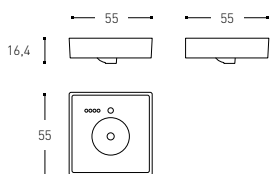

INCH 21.7x21.7x6.5



◻
1 DRAWER CABINET
 MUEBLE 1 CAJÓN

755 00 0902 AAA AAA
 MATTE LACQUERED / LACADO MATE
755 00 0902 BBB BBB
 GLOSSY LACQUERED / LACADO BRILLO

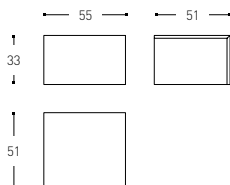

INCH 21.7x20.1x6.5



◻
1 DRAWER CABINET
 MUEBLE 1 CAJÓN

755 00 1302 AAA AAA
 MATTE LACQUERED / LACADO MATE
755 00 1302 BBB BBB
 GLOSSY LACQUERED / LACADO BRILLO

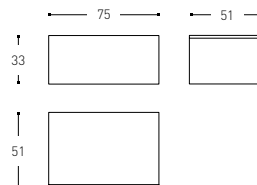

INCH 29.5x20.1x6.5



○
TOWEL RACK
 TOALLERO

755 CC 64

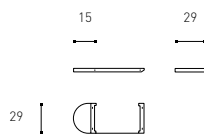

INCH 5.91x11.4



○
TOWEL RACK
 TOALLERO

755 CC 65

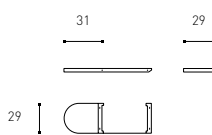

INCH 12.2x11.4



○
DOUBLE TOWEL RACK
 TOALLERO DOBLE

755 CC 61

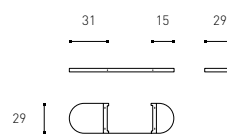

INCH 5.91+12.2x11.4



◆●
MIRROR
ESPEJO

755 DD 01 *

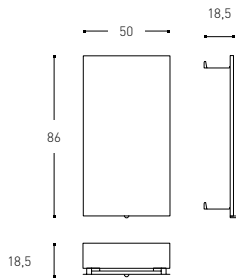

INCH 19.7x7.3x33.9



◆●
SLIDING MIRROR
ESPEJO CORREDERO

755 DD 02 *

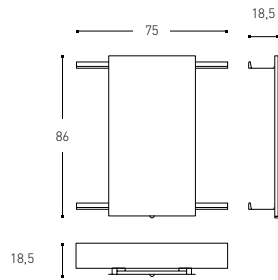

INCH 29.5x7.3x33.9



◆●
SLIDING MIRROR
ESPEJO CORREDERO

755 DD 03 *

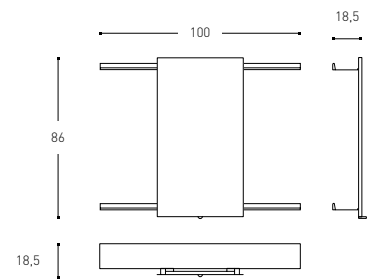

INCH 39.4x7.3x33.9

*
INCLUDES 1 CONTAINER AND 1 TALL CONTAINER
INCLUYE 1 CONTAINER Y 1 CONTAINER ALTO



△
BASKET
CONTAINER

755 05 49

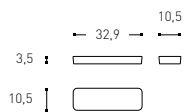

INCH 12.9x4.1x1.4



△
HIGH BASKET
CONTAINER ALTO

755 05 48

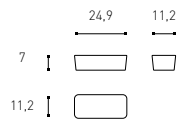

INCH 9.8x4.4x2.8



●
SHELF (X2)
ESTANTE (X2)

755 DD 47
50 CM

755 DD 44
75 CM

755 DD 50
100 CM

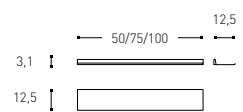

INCH 2.9x4.9x1.2



Global Container

Design by **Claramunt De Mas**



△
BASKET
CONTAINER

755 06 33

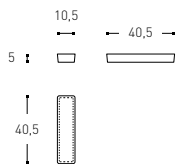

INCH 4.1x15.9x1.9



●
BILED WALL LAMP REMOTE CONTROL
APLIQUE BILED CON MANDO A DISTANCIA

755 0190
(LED CII IP44 1X12W) (INPUT 110-220V)



INCH 19.4x1x0.5



●
LEGS SET (X2)
CONJUNTO PIES (X2)

755 0198

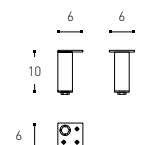

INCH 2.4x2.4x3.9



●
VALVE
VÁLVULA

34103 87

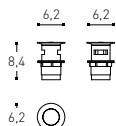

INCH 2.4x2.4x3.3

Spare parts | Recambios

DRYWALL ANCHOR
TACO PLADUR

3410637

SPARE PART OF / RECAMBIO DE
775000902AAABBB, 755001302AAABBB, 7555901, 7554501, 7555901, 7554502, 7554503, 7555902, 7555903, 7558901, 7558902, 7558903

WASHBASIN/MIRROR MOUNTING SET
ACCESORIO SUJECIÓN LAVABO/ESPEJO

3307500

SPARE PART OF / RECAMBIO DE
7550510

TRAP
SIFÓN

3410590

CHROME / CROMO

SPARE PART OF / RECAMBIO DE
7550510

CABINET WITH WASHBASIN MOUNTING SET
ACCESORIO SUJECIÓN MUEBLE CON LAVABO

3410446

SPARE PART OF / RECAMBIO DE
775000902AAABBB, 755001302AAABBB

DRAWER
CAJÓN

3419154

SPARE PART OF / RECAMBIO DE
755000902AAABBB

3419155

SPARE PART OF / RECAMBIO DE
755001302AAABBB

RAIL SYSTEM
JUEGO DE GUÍAS

3419156

SPARE PART OF / RECAMBIO DE
775000902AAABBB, 755001302AAABBB

FIXING TRIGGER FOR RIGHT RAIL
GATILLO SUJECIÓN GUÍA DERECHA

3419149

SPARE PART OF / RECAMBIO DE
775000902AAABBB, 755001302AAABBB

FIXING TRIGGER FOR LEFT RAIL
GATILLO SUJECIÓN GUÍA IZQUIERDA

3419150

SPARE PART OF / RECAMBIO DE
775000902AAABBB, 755001302AAABBB

FRONT PART (55CM)
FRONTAL (55CM)

75599001BBB

MATTE / MATE

SPARE PART OF / RECAMBIO DE
755000902AAABBB

75599001BBB

GLOSSY / BRILLO

SPARE PART OF / RECAMBIO DE
755000902AAABBB

FRONT PART (75CM)
FRONTAL (75CM)

75599002BBB

MATTE / MATE

SPARE PART OF / RECAMBIO DE
755001302AAABBB

75599002BBB

GLOSSY / BRILLO

SPARE PART OF / RECAMBIO DE
755001302AAABBB

STOPPER SET
CONJUNTO TOPE

3410654

SPARE PART OF / RECAMBIO DE
7555901, 7554501, 7554502, 7554503, 7555902, 7555903, 7558901, 7558902, 7558903

GLASS CLIP SET
CONJUNTO 2 CLIPS

3410655

SPARE PART OF / RECAMBIO DE
7555901, 7554501, 7554502, 7554503, 7555902, 7555903, 7558901, 7558902, 7558903

MIRROR DOOR HANDLE
TIRADOR PUERTA ESPEJO

3410656

SPARE PART OF / RECAMBIO DE
7555901, 7554501, 7554502, 7554503, 7555902, 7555903, 7558901, 7558902, 7558903

WALL MOUNTING SET FOR MIRROR
ACCESORIO SUJECIÓN ESPEJO

3410713

SPARE PART OF / RECAMBIO DE
7550190

REMOTE CONTROL
MANDO A DISTANCIA

3410712

SPARE PART OF / RECAMBIO DE
7550190



Modular

Design by Àlex Armenter







74N 116 116 00 06 2 21 (X2)
1 DRAWER ADDITIONAL UNIT
MUEBLE AUXILIAR 1 CAJÓN
(40X45X25)

74N 106 106 00 06 2 21 (X2)
1 DRAWER ADDITIONAL UNIT
MUEBLE AUXILIAR 1 CAJÓN
(40X45X25)

744 11 07 00 00 0806 (X2)
CRISTALPLANT COUNTER TOP
ENCIMERA CRISTALPLANT
(80,6X45X1,5)



Modular is the most intelligent and flexible solution for organisation and storage requirements in the bathroom environment.

Modular es la solución más inteligente y flexible para las necesidades de orden y almacenaje en el entorno del baño.

74N 106 106 10 14 3 12 (X2)
2 DRAWERS CABINET FOR WASHBASIN
MUEBLE CON 2 CAJONES PARA LAVABO
(80X55X50)

74N 116 116 00 14 8 12
2 DOORS ADDITIONAL UNIT
MUEBLE AUXILIAR CON 2 PUERTAS
(80X55X50)

74C 11 09 22 00 2407
CRISTALPLANT COUNTER TOP WITH 2 SINKS
ENCIMERA CRISTALPLANT 2 SENOS
(240,7X55X1,5)



744 129 131 00 28 1 00
CABINET
ARMARIO
(40X20X150)



744 129 000 00 10 A 04 (X2)
MEDICINE CABINET
ARMARIO ESPEJO
(60X13X80)



744 11 07 11 00 2208
CRISTALPLANT COUNTER TOP
ENCIMERA CRISTALPLANT
(220,8X55X1,5)

74N 129 129 00 14 8 02
2 DOORS ADDITIONAL UNIT
MUEBLE AUXILIAR CON 2 PUERTAS
(80X55X70)

74N 129 129 00 04 7 04 (X2)
1 DOOR ADDITIONAL UNIT
MUEBLE AUXILIAR CON 1 PUERTA
(30X55X70)

74N 129 131 10 14 3 02
2 DRAWERS CABINET FOR WASHBASIN
MUEBLE PARA LAVABO 2 CAJONES
(80X55X70)







74N 140 139 00 04 7 11 (X2)
1 DOOR ADDITIONAL UNIT
MUEBLE AUXILIAR CON 1 PUERTA
(30X45X50)

74N 140 139 10 10 3 11
2 DRAWERS CABINET FOR WASHBASIN
MUEBLE PARA LAVABO 2 CAJONES
(60X45X50)

74N 140 139 00 06 3 11
2 DRAWERS ADDITIONAL UNIT
MUEBLE AUXILIAR CON 2 CAJONES
(40X45X50)

74C 11 07 11 00 1608
CRISTALPLANT COUNTER TOP WITH 1 SINK
ENCIMERA CRISTALPLANT 1 SENO

744 140 000 00 10 A 06
MEDICINE CABINET WITH LIGHTING
ARMARIO ESPEJO CON LUZ
(60X13X80)



74N 108 108 00 06 2 22 (X3)
1 DRAWER ADDITIONAL UNIT
MUEBLE AUXILIAR 1 CAJÓN
(40X55X25)

74N 108 108 10 14 3 12
2 DRAWERS CABINET FOR WASHBASIN
MUEBLE PARA LAVABO 2 CAJONES
(80X55X50)

74S 11 09 10 00 2008
CRISTALPLANT COUNTER TOP
ENCIMERA CRISTALPLANT
(200,8X55X1.5)

744 111 003
COUNTERTOP WASHBASIN
LAVABO DE SOBRE-ENCIMERA
(58X37X13)







74N 108 108 00 06 2 22 (X3)
1 DRAWER ADDITIONAL UNIT
MUEBLE AUXILIAR 1 CAJÓN
(40X55X25)

74N 108 108 10 14 3 12
2 DRAWERS CABINET FOR WASHBASIN
MUEBLE PARA LAVABO 2 CAJONES
(80X55X50)

74S 11 09 10 00 2008
CRISTALPLANT COUNTER TOP
ENCIMERA CRISTALPLANT
(200,8X55X1,5)

744 111 003
COUNTERTOP WASHBASIN
LAVABO DE SOBRE-ENCIMERA
(58X37X13)





744 102 118 00 10 8 01
2 DOORS ADDITIONAL UNIT
MUEBLE AUXILIAR CON 2 PUERTAS
(60X45X70)

744 102 116 00 04 7 01
1 DOOR ADDITIONAL UNIT
MUEBLE AUXILIAR CON 1 PUERTA
(30X45X70)

744 102 124 00 04 7 01
1 DOOR ADDITIONAL UNIT
MUEBLE AUXILIAR CON 1 PUERTA
(30X45X70)

744 102 126 00 04 7 01
1 DOOR ADDITIONAL UNIT
MUEBLE AUXILIAR CON 1 PUERTA
(30X45X70)

744 11 07 00 00 1508 (X2)
CRISTALPLANT COUNTER TOP
ENCIMERA CRISTALPLANT
(150,8X45X1,5)



74N 129 129 00 08 3 01 (X2)
2 DRAWERS ADDITIONAL UNIT
MUEBLE AUXILIAR CON 2 CAJONES
50X45X70

74N 129 129 10 18 8 01 (X2)
2 DOORS CABINET FOR WASHBASIN
MUEBLE PARA LAVABO 2 PUERTAS
100X45X70

744 07 07 22 00 3007
PHENOLIC RESIN COUNTER TOP
ENCIMERA RESINA FENÓLICA

744 03 00 00 (X2)
VIT-TECH WASHBASIN
LAVABO VIT-TECH
46X34X12,5

744 129 000 00 08 A 01 (X2)
MEDICINE CABINET WITH LIGHTING
ARMARIO ESPEJO CON LUZ
(50X13X80)







74N 126 126 00 08 7 04 (X2)
1 DOOR ADDITIONAL UNIT
MUEBLE AUXILIAR CON 1 PUERTA
(50X55X70)

74N 126 126 10 18 3 02
2 DRAWERS CABINET FOR WASHBASIN
MUEBLE PARA LAVABO 2 CAJONES
(100X55X70)

744 08 09 11 01 2007
PHENOLIC RESIN COUNTER TOP
ENCIMERA RESINA FENÓLICA
(200,7X55X1,5)

744 06 00 00
VIT-TECH WASHBASIN
LAVABO VIT-TECH
(46X34X12,5)



Modular

Design by Àlex Armenter



Self & soft close with new rail system which can be completely removed. The long lasting durability of drawers is assured by quality control tests (up to 20,000 times).

Apertura y cierre amortiguado con guías de extracción total ocultas soft & self close. La durabilidad de los cajones está asegurada ya que han superado con éxito hasta 20.000 ciclos en los test de control de calidad.



Straight edged fittings furniture available in two depths, 45 and 55 cm. Units available in various widths, from 30 to 100 cm. New units, 25 or 50 cm high, that allow for an infinite number of combinations.

Mobiliario de estética lineal con dos profundidades, de 45 y 55 cm. Múltiples anchos de mueble disponibles, de 30 a 100 cm. Nuevos módulos de 25 y 50 cm de altura, que permiten crear infinitas combinaciones.



Units include an optional storage systems such as containers, dividers and a hanging wastebaskets.

Módulos que integran sistemas opcionales de almacenaje y orden como containers, separadores y papelera.

The drawers, with a handle, are completely removable to let the most pleasant use.

Los cajones, con tirador integrado, se extraen totalmente permitiendo un uso más cómodo.

Furniture | Muebles

Eco friendly: furniture made in Spain with certified wood board (PEFC/FSC) following the chain of custody in forestry. Lacquered finishing and high quality laminate.

Producto ambientalmente responsable: muebles fabricados en España con tableros de madera certificada (PEFC/FSC) conforme la cadena de custodia de productos forestales. Acabados lacados y laminados de alta gama.



Modular has successfully passed the high demanding tests of long-lasting durability and resistance to extreme uses (static charge or impact testing) to assure long-lasting durability of the product.

Toda la gama **Modular** ha superado con éxito exigentes tests de durabilidad y resistencia a usos extremos (cargas estáticas o test de impacto), para asegurar una larga vida al producto.



Leg set (optional).

Pies opcionales.



The wardrobes and front parts of the doors do not have handles thanks to the Touch Latch Senso® (Push-Open) opening system.

Los frontales de muebles y armarios están libres de tiradores gracias al sistema de apertura Touch Latch Senso® (Push-Open).



Easy wall fixing & adjustable attachment systems.

Fácil anclaje a pared y sistemas de fijación regulables.



COMPOSITION / COMPOSICIÓN

ORGANISE YOUR MODULAR PROJECT WITH | MODULAR PLAN
CONFIGURA EL ESPACIO DEL BAÑO CON | www.icosmic.com



CABINETS FOR WASHBASIN
MUEBLES PARA LAVABO

DEPTH / PROFUNDIDAD
45 CM / 55 CM
INCH 17.7 / 21.6

+

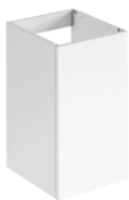

ADDITIONAL UNITS
MUEBLES AUXILIARES

DEPTH / PROFUNDIDAD
45 CM / 55 CM
INCH 17.7 / 21.6

+



COUNTER TOP WITH BUILT IN WASHBASIN
ENCIMERAS CON LAVABO INTEGRADO

DEPTH / PROFUNDIDAD
45 CM / 55 CM
INCH 17.7 / 21.6



CABINETS FOR WASHBASIN
MUEBLES PARA LAVABO

DEPTH / PROFUNDIDAD
45 CM / 55 CM
INCH 17.7 / 21.6

+

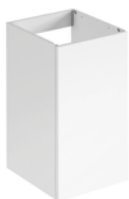

ADDITIONAL UNITS
MUEBLES AUXILIARES

DEPTH / PROFUNDIDAD
45 CM / 55 CM
INCH 17.7 / 21.6

+



COUNTER TOP
ENCIMERAS

DEPTH / PROFUNDIDAD
45 CM / 55 CM
INCH 17.7 / 21.6

+



COUNTERTOP WASHBASIN
LAVABO DE SOBRE-ENCIMERA



CABINETS FOR WASHBASIN
MUEBLES PARA LAVABO

DEPTH / PROFUNDIDAD
45 CM / 55 CM
INCH 17.7 / 21.6

+

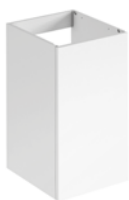

ADDITIONAL UNITS
MUEBLES AUXILIARES

DEPTH / PROFUNDIDAD
45 CM / 55 CM
INCH 17.7 / 21.6

+



COUNTER TOP
ENCIMERAS

DEPTH / PROFUNDIDAD
45 CM / 55 CM
INCH 17.7 / 21.6

+



BUILT IN WASHBASIN
LAVABO ENCASTRADO

OPTIONAL / OPCIONAL



LEGS
PATAS

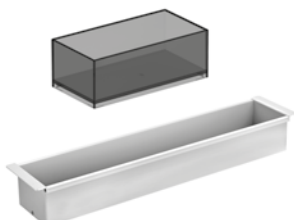

ACCESSORIES
ACCESORIOS



MEDICINE CABINETS
ARMARIOS ESPEJO



CABINET
ARMARIO

CODE / CODIFICACIÓN

74N	AAA	AAA	10	10	8	01
74N	AAA	BBB	10	10	8	01
74N	AAA	CCC	10	10	8	01
74N	BBB	BBB	10	10	8	01
74N	BBB	CCC	10	10	8	01

PVC STRUCTURE + PVC FRONT
CUERPO PVC + FRONTAL PVC

PVC STRUCTURE + MATTE FRONT
CUERPO PVC + FRONTAL MATE

PVC STRUCTURE + GLOSSY FRONT
CUERPO PVC + FRONTAL BRILLO

MATTE STRUCTURE + MATTE FRONT
CUERPO MATE + FRONTAL MATE

MATTE STRUCTURE + GLOSSY FRONT
CUERPO MATE + FRONTAL BRILLO





COLLECTION COLECCIÓN	STRUCTURE COLOUR COLOR CUERPO	DOOR COLOUR COLOR PUERTA	TYPE MODELO			
-------------------------	----------------------------------	-----------------------------	----------------	--	--	--

FINISHES / ACABADOS

AAA

PVC

STRUCTURE AND FRONT COLOUR
COLOR CUERPO Y FRONTAL

	129 MATTE WHITE BLANCO MATE
	130 MATE ANTHRACITE ANTRACITA MATE
	131 BLEACHED OAK ROBLE CLARO
	132 SLATE OAK ROBLE PIZARRA

BBB

MATTE LACQUERED / LACADO MATE

STRUCTURE AND FRONT COLOUR
COLOR CUERPO Y FRONTAL

	102 MATE WHITE BLANCO MATE		116 MATTE GREEN VERDE MATE
	104 MATTE LIGHT GREY GRIS CLARO MATE		126 MATTE BLUE AZUL MATE
	110 MATTE LIGHT CREAM CREMA LIGHT MATE		124 MATTE AUBERGINE BERENJENA MATE
	140 MATTE OLIVE GREY GRIS OLIVA MATE		122 MATTE PINK ROSA MATE
	112 MATTE MINK VISON MATE		120 MATTE RUBY RUBI MATE
	106 MATTE AMETHYST GREY GRIS AMATISTA MATE		118 MATTE ORANGE NARANJA MATE
	114 MATTE CHOCOLATE CHOCOLATE MATE		128 MATTE METALLIC GREY GRIS METALIZADO MATE
	108 MATTE BLACK NEGRO MATE		

CCC

GLOSSY LACQUERED / LACADO BRILLO

FRONT COLOUR
COLOR FRONTAL

	064 GLOSSY WHITE BLANCO BRILLO		115 GLOSSY GREEN VERDE BRILLO
	103 GLOSSY LIGHT GREY GRIS CLARO BRILLO		125 GLOSSY BLUE AZUL BRILLO
	109 GLOSSY LIGHT CREAM CREMA LIGHT BRILLO		123 GLOSSY AUBERGINE BERENJENA BRILLO
	139 GLOSSY OLIVE GREY GRIS OLIVA BRILLO		121 GLOSSY PINK ROSA BRILLO
	111 GLOSSY MINK VISON BRILLO		119 GLOSSY RUBY RUBI BRILLO
	105 GLOSSY AMETHYST GREY GRIS AMATISTA BRILLO		117 GLOSSY ORANGE NARANJA BRILLO
	113 GLOSSY CHOCOLATE CHOCOLATE BRILLO		127 GLOSSY METALLIC GREY GRIS METALIZADO BRILLO
	034 GLOSSY BLACK NEGRO BRILLO		

Modular

Design by Àlex Armenter

DEPTH
PROFUNDIDAD
45 CM
INCH 17.7

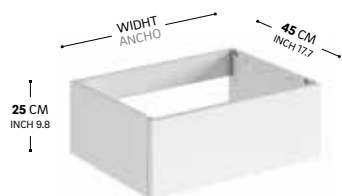

1 DRAWER CABINET FOR WASHBASIN
MUEBLE CON 1 CAJÓN PARA LAVABO

FINISHES ACABADOS	WIDTH ANCHO		
	60 CM INCH 23.6	80 CM INCH 31.5	100 CM INCH 39.4
PVC+PVC PVC+PVC	-	-	-
PVC+MATTE PVC+MATE	-	-	-
MATTE+MATTE MATE+MATE	-	-	-
PVC+GLOSSY PVC+BRILLO	-	-	-
MATTE+GLOSSY MATE+BRILLO	-	-	-

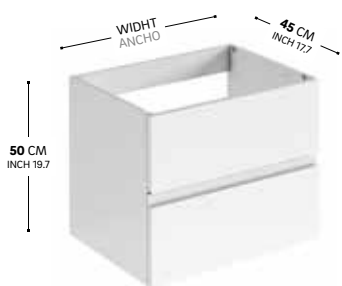

2 DRAWERS CABINET FOR WASHBASIN
MUEBLE CON 2 CAJONES PARA LAVABO

FINISHES ACABADOS	WIDTH ANCHO		
	60 CM INCH 23.6	80 CM INCH 31.5	100 CM INCH 39.4
PVC+PVC PVC+PVC	-	-	-
PVC+MATTE PVC+MATE	-	-	-
MATTE+MATTE MATE+MATE	-	-	-
PVC+GLOSSY PVC+BRILLO	-	-	-
MATTE+GLOSSY MATE+BRILLO	-	-	-

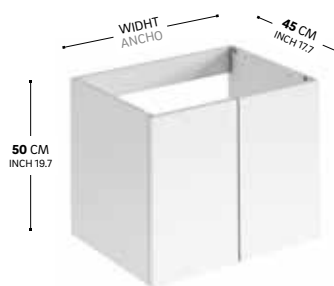

2 DOORS CABINET FOR WASHBASIN
MUEBLE CON 2 PUERTAS PARA LAVABO

FINISHES ACABADOS	WIDTH ANCHO		
	60 CM INCH 23.6	80 CM INCH 31.5	100 CM INCH 39.4
PVC+PVC PVC+PVC	-	-	-
PVC+MATTE PVC+MATE	-	-	-
MATTE+MATTE MATE+MATE	-	-	-
PVC+GLOSSY PVC+BRILLO	-	-	-
MATTE+GLOSSY MATE+BRILLO	-	-	-

Cabinets for washbasin | Muebles para lavabo



2 DRAWERS CABINET FOR WASHBASIN
MUEBLE CON 2 CAJONES PARA LAVABO

FINISHES ACABADOS	WIDTH ANCHO		
	60 CM INCH 23.6	80 CM INCH 31.5	100 CM INCH 39.4
PVC+PVC PVC+PVC	-	-	-
PVC+MATTE PVC+MATE	-	-	-
MATTE+MATTE MATE+MATE	-	-	-
PVC+GLOSSY PVC+BRILLO	-	-	-
MATTE+GLOSSY MATE+BRILLO	-	-	-

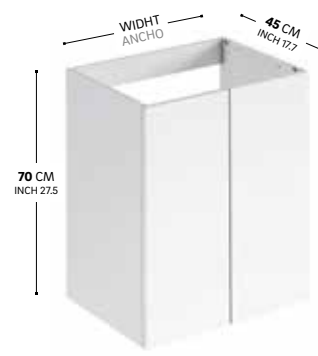

2 DOORS CABINET FOR WASHBASIN
MUEBLE CON 2 PUERTAS PARA LAVABO

FINISHES ACABADOS	WIDTH ANCHO		
	60 CM INCH 23.6	80 CM INCH 31.5	100 CM INCH 39.4
PVC+PVC PVC+PVC	-	-	-
PVC+MATTE PVC+MATE	-	-	-
MATTE+MATTE MATE+MATE	-	-	-
PVC+GLOSSY PVC+BRILLO	-	-	-
MATTE+GLOSSY MATE+BRILLO	-	-	-

Modular

Design by Àlex Armenter

DEPTH
PROFUNDIDAD
45 CM
INCH 17.7



■ □
CABINET
ARMARIO

744 AAA AAA 00 28 100
PVC+PVC

744 AAA BBB 00 28 100
PVC+MATTE / PVC+MATE

744 AAA CCC 00 28 100
PVC+GLOSSY / PVC+BRILLO

744 BBB BBB 00 28 100
MATTE+MATTE / MATE+MATE

744 BBB CCC 00 28 100
MATTE+GLOSSY / MATE+BRILLO

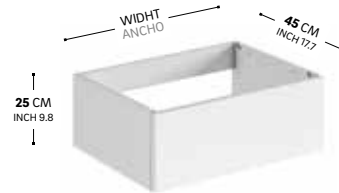
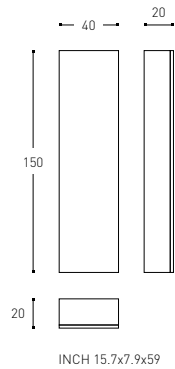

■ □
1 DRAWER ADDITIONAL UNIT
MUEBLE AUXILIAR CON 1 CAJÓN

FINISHES ACABADOS	WIDTH ANCHO				
	40 CM INCH 15.7	50 CM INCH 19.7	60 CM INCH 23.6	80 CM INCH 31.5	100 CM INCH 39.4
PVC+PVC PVC+PVC	-	-	-	-	-
PVC+MATTE PVC+MATE	-	-	-	-	-
MATTE+MATTE MATE+MATE	-	-	-	-	-
PVC+GLOSSY PVC+BRILLO	-	-	-	-	-
MATTE+GLOSSY MATE+BRILLO	-	-	-	-	-

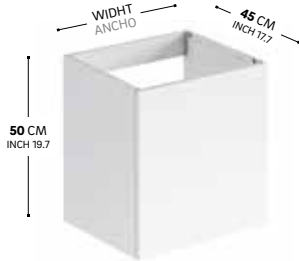

■ □
1 DOOR ADDITIONAL UNIT
MUEBLE AUXILIAR CON 1 PUERTA

FINISHES ACABADOS	WIDTH ANCHO		
	30 CM INCH 11.8	40 CM INCH 15.7	50 CM INCH 19.7
PVC+PVC PVC+PVC	-	-	-
PVC+MATTE PVC+MATE	-	-	-
MATTE+MATTE MATE+MATE	-	-	-
PVC+GLOSSY PVC+BRILLO	-	-	-
MATTE+GLOSSY MATE+BRILLO	-	-	-

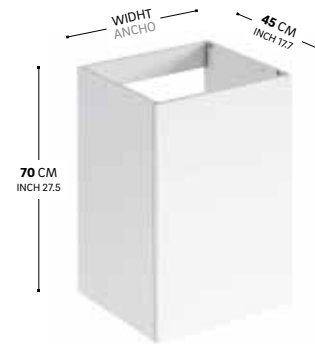

■ □
1 DOOR ADDITIONAL UNIT
MUEBLE AUXILIAR CON 1 PUERTA

FINISHES ACABADOS	WIDTH ANCHO		
	30 CM INCH 11.8	40 CM INCH 15.7	50 CM INCH 19.7
PVC+PVC PVC+PVC	-	-	-
PVC+MATTE PVC+MATE	-	-	-
MATTE+MATTE MATE+MATE	-	-	-
PVC+GLOSSY PVC+BRILLO	-	-	-
MATTE+GLOSSY MATE+BRILLO	-	-	-

Additional units | Muebles auxiliares

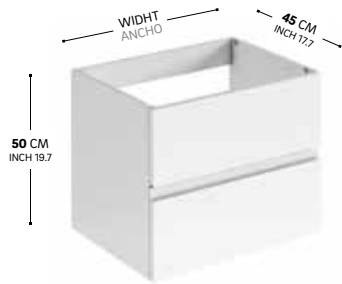

■ □
2 DRAWERS ADDITIONAL UNIT
 MUEBLE AUXILIAR CON 2 CAJONES

FINISHES ACABADOS	WIDTH ANCHO				
	40 CM INCH 15.7	50 CM INCH 19.7	60 CM INCH 23.6	80 CM INCH 31.5	100 CM INCH 39.4
PVC+PVC PVC+PVC	-	-	-	-	-
PVC+MATTE PVC+MATE	-	-	-	-	-
MATTE+MATTE MATE+MATE	-	-	-	-	-
PVC+GLOSSY PVC+BRILLO	-	-	-	-	-
MATTE+GLOSSY MATE+BRILLO	-	-	-	-	-



■ □
2 DRAWERS ADDITIONAL UNIT
 MUEBLE AUXILIAR CON 2 CAJONES

FINISHES ACABADOS	WIDTH ANCHO				
	40 CM INCH 15.7	50 CM INCH 19.7	60 CM INCH 23.6	80 CM INCH 31.5	100 CM INCH 39.4
PVC+PVC PVC+PVC	-	-	-	-	-
PVC+MATTE PVC+MATE	-	-	-	-	-
MATTE+MATTE MATE+MATE	-	-	-	-	-
PVC+GLOSSY PVC+BRILLO	-	-	-	-	-
MATTE+GLOSSY MATE+BRILLO	-	-	-	-	-

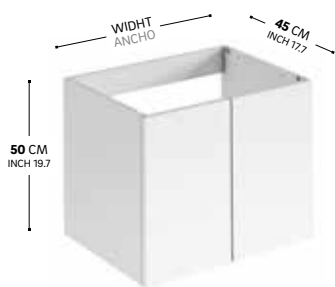

■ □
2 DOORS ADDITIONAL UNIT
 MUEBLE AUXILIAR CON 2 PUERTAS

FINISHES ACABADOS	WIDTH ANCHO		
	60 CM INCH 23.6	80 CM INCH 31.5	100 CM INCH 39.4
PVC+PVC PVC+PVC	-	-	-
PVC+MATTE PVC+MATE	-	-	-
MATTE+MATTE MATE+MATE	-	-	-
PVC+GLOSSY PVC+BRILLO	-	-	-
MATTE+GLOSSY MATE+BRILLO	-	-	-

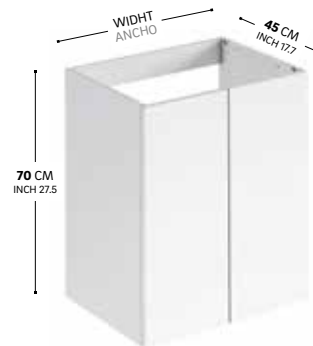

■ □
2 DOORS ADDITIONAL UNIT
 MUEBLE AUXILIAR CON 2 PUERTAS

FINISHES ACABADOS	WIDTH ANCHO		
	60 CM INCH 23.6	80 CM INCH 31.5	100 CM INCH 39.4
PVC+PVC PVC+PVC	-	-	-
PVC+MATTE PVC+MATE	-	-	-
MATTE+MATTE MATE+MATE	-	-	-
PVC+GLOSSY PVC+BRILLO	-	-	-
MATTE+GLOSSY MATE+BRILLO	-	-	-

THE SHOWN MEASURES ARE GIVEN AS AN INDICATION (ONLY) AND NOT VALID FOR THE INSTALLATION.
 LAS MEDIDAS INDICADAS SON ORIENTATIVAS, NO SON VÁLIDAS PARA LA INSTALACIÓN.

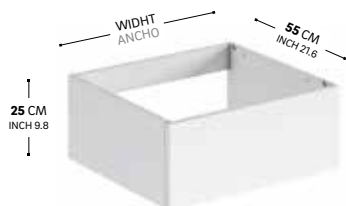

1 DRAWER CABINET FOR WASHBASIN
MUEBLE CON 1 CAJÓN PARA LAVABO

FINISHES ACABADOS	WIDTH ANCHO		
	60 CM INCH 23.6	80 CM INCH 31.5	100 CM INCH 39.4
PVC+PVC PVC+PVC	-	-	-
PVC+MATTE PVC+MATE	-	-	-
MATTE+MATTE MATE+MATE	-	-	-
PVC+GLOSSY PVC+BRILLO	-	-	-
MATTE+GLOSSY MATE+BRILLO	-	-	-

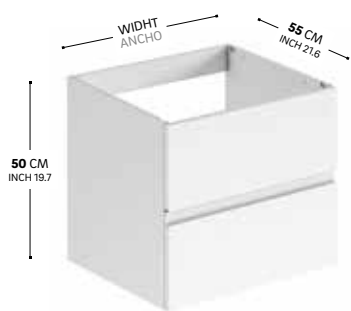

2 DRAWERS CABINET FOR WASHBASIN
MUEBLE CON 2 CAJONES PARA LAVABO

FINISHES ACABADOS	WIDTH ANCHO		
	60 CM INCH 23.6	80 CM INCH 31.5	100 CM INCH 39.4
PVC+PVC PVC+PVC	-	-	-
PVC+MATTE PVC+MATE	-	-	-
MATTE+MATTE MATE+MATE	-	-	-
PVC+GLOSSY PVC+BRILLO	-	-	-
MATTE+GLOSSY MATE+BRILLO	-	-	-

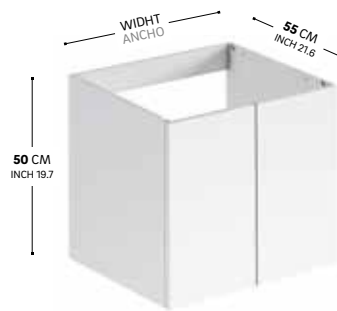

2 DOORS CABINET FOR WASHBASIN
MUEBLE CON 2 PUERTAS PARA LAVABO

FINISHES ACABADOS	WIDTH ANCHO		
	60 CM INCH 23.6	80 CM INCH 31.5	100 CM INCH 39.4
PVC+PVC PVC+PVC	-	-	-
PVC+MATTE PVC+MATE	-	-	-
MATTE+MATTE MATE+MATE	-	-	-
PVC+GLOSSY PVC+BRILLO	-	-	-
MATTE+GLOSSY MATE+BRILLO	-	-	-

Cabinets for washbasin | Muebles para lavabo

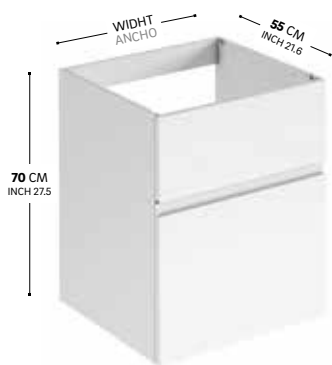

2 DRAWERS CABINET FOR WASHBASIN
MUEBLE CON 2 CAJONES PARA LAVABO

FINISHES ACABADOS	WIDTH ANCHO		
	60 CM INCH 23.6	80 CM INCH 31.5	100 CM INCH 39.4
PVC+PVC PVC+PVC	-	-	-
PVC+MATTE PVC+MATE	-	-	-
MATTE+MATTE MATE+MATE	-	-	-
PVC+GLOSSY PVC+BRILLO	-	-	-
MATTE+GLOSSY MATE+BRILLO	-	-	-

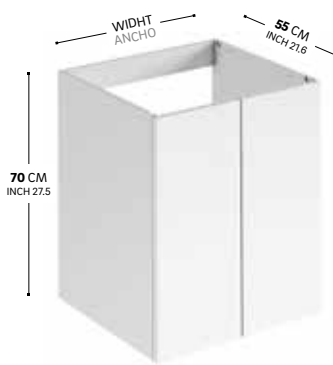

2 DOORS CABINET FOR WASHBASIN
MUEBLE CON 2 PUERTAS PARA LAVABO

FINISHES ACABADOS	WIDTH ANCHO		
	60 CM INCH 23.6	80 CM INCH 31.5	100 CM INCH 39.4
PVC+PVC PVC+PVC	-	-	-
PVC+MATTE PVC+MATE	-	-	-
MATTE+MATTE MATE+MATE	-	-	-
PVC+GLOSSY PVC+BRILLO	-	-	-
MATTE+GLOSSY MATE+BRILLO	-	-	-

Modular

Design by Àlex Armenter

DEPTH
PROFUNDIDAD
55 CM
INCH 21.6



■ □
CABINET
ARMARIO

744 AAA AAA 00 28 100
PVC+PVC

744 AAA BBB 00 28 100
PVC+MATTE / PVC+MATE

744 AAA CCC 00 28 100
PVC+GLOSSY / PVC+BRILLO

744 BBB BBB 00 28 100
MATTE+MATTE / MATE+MATE

744 BBB CCC 00 28 100
MATTE+GLOSSY / MATE+BRILLO

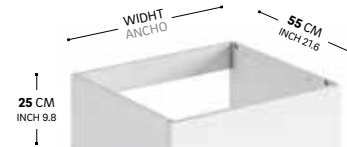
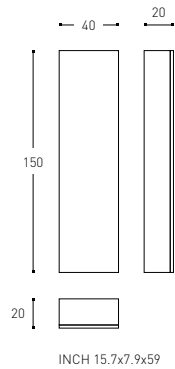

■ □
1 DRAWER ADDITIONAL UNIT
MUEBLE AUXILIAR CON 1 CAJÓN

FINISHES ACABADOS	WIDTH ANCHO				
	40 CM INCH 15.7	50 CM INCH 19.7	60 CM INCH 23.6	80 CM INCH 31.5	100 CM INCH 39.4
PVC+PVC PVC+PVC	-	-	-	-	-
PVC+MATTE PVC+MATE	-	-	-	-	-
MATTE+MATTE MATE+MATE	-	-	-	-	-
PVC+GLOSSY PVC+BRILLO	-	-	-	-	-
MATTE+GLOSSY MATE+BRILLO	-	-	-	-	-

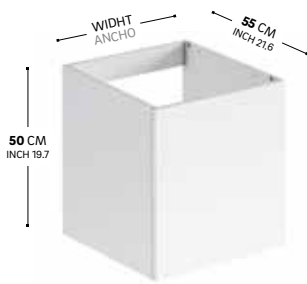

■ □
1 DOOR ADDITIONAL UNIT
MUEBLE AUXILIAR CON 1 PUERTA

FINISHES ACABADOS	WIDTH ANCHO		
	30 CM INCH 11.8	40 CM INCH 15.7	50 CM INCH 19.7
PVC+PVC PVC+PVC	-	-	-
PVC+MATTE PVC+MATE	-	-	-
MATTE+MATTE MATE+MATE	-	-	-
PVC+GLOSSY PVC+BRILLO	-	-	-
MATTE+GLOSSY MATE+BRILLO	-	-	-

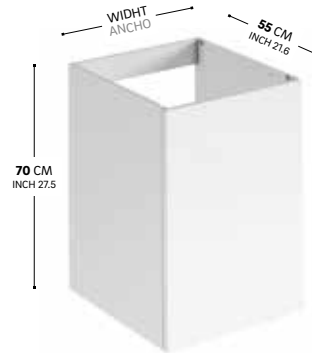

■ □
1 DOOR ADDITIONAL UNIT
MUEBLE AUXILIAR CON 1 PUERTA

FINISHES ACABADOS	WIDTH ANCHO		
	30 CM INCH 11.8	40 CM INCH 15.7	50 CM INCH 19.7
PVC+PVC PVC+PVC	-	-	-
PVC+MATTE PVC+MATE	-	-	-
MATTE+MATTE MATE+MATE	-	-	-
PVC+GLOSSY PVC+BRILLO	-	-	-
MATTE+GLOSSY MATE+BRILLO	-	-	-

Additional units | Muebles auxiliares

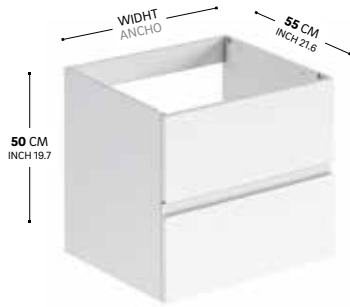

■ □
2 DRAWERS ADDITIONAL UNIT
 MUEBLE AUXILIAR CON 2 CAJONES

FINISHES ACABADOS	WIDTH ANCHO				
	40 CM INCH 15.7	50 CM INCH 19.7	60 CM INCH 23.6	80 CM INCH 31.5	100 CM INCH 39.4
PVC+PVC PVC+PVC	-	-	-	-	-
PVC+MATTE PVC+MATE	-	-	-	-	-
MATTE+MATTE MATE+MATE	-	-	-	-	-
PVC+GLOSSY PVC+BRILLO	-	-	-	-	-
MATTE+GLOSSY MATE+BRILLO	-	-	-	-	-

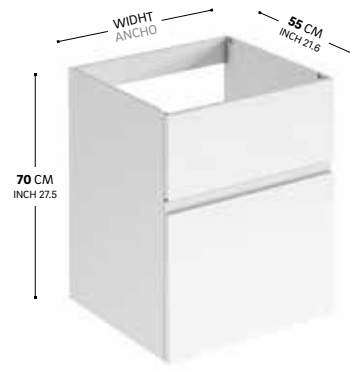

■ □
2 DRAWERS ADDITIONAL UNIT
 MUEBLE AUXILIAR CON 2 CAJONES

FINISHES ACABADOS	WIDTH ANCHO				
	40 CM INCH 15.7	50 CM INCH 19.7	60 CM INCH 23.6	80 CM INCH 31.5	100 CM INCH 39.4
PVC+PVC PVC+PVC	-	-	-	-	-
PVC+MATTE PVC+MATE	-	-	-	-	-
MATTE+MATTE MATE+MATE	-	-	-	-	-
PVC+GLOSSY PVC+BRILLO	-	-	-	-	-
MATTE+GLOSSY MATE+BRILLO	-	-	-	-	-

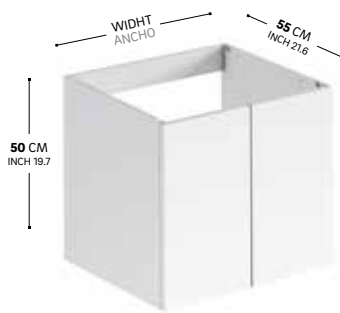

■ □
2 DOORS ADDITIONAL UNIT
 MUEBLE AUXILIAR CON 2 PUERTAS

FINISHES ACABADOS	WIDTH ANCHO		
	60 CM INCH 23.6	80 CM INCH 31.5	100 CM INCH 39.4
PVC+PVC PVC+PVC	-	-	-
PVC+MATTE PVC+MATE	-	-	-
MATTE+MATTE MATE+MATE	-	-	-
PVC+GLOSSY PVC+BRILLO	-	-	-
MATTE+GLOSSY MATE+BRILLO	-	-	-

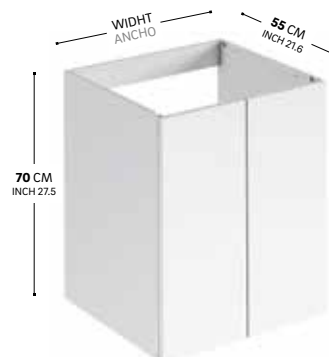

■ □
2 DOORS ADDITIONAL UNIT
 MUEBLE AUXILIAR CON 2 PUERTAS

FINISHES ACABADOS	WIDTH ANCHO		
	60 CM INCH 23.6	80 CM INCH 31.5	100 CM INCH 39.4
PVC+PVC PVC+PVC	-	-	-
PVC+MATTE PVC+MATE	-	-	-
MATTE+MATTE MATE+MATE	-	-	-
PVC+GLOSSY PVC+BRILLO	-	-	-
MATTE+GLOSSY MATE+BRILLO	-	-	-

THE SHOWN MEASURES ARE GIVEN AS AN INDICATION (ONLY) AND NOT VALID FOR THE INSTALLATION.
 LAS MEDIDAS INDICADAS SON ORIENTATIVAS, NO SON VÁLIDAS PARA LA INSTALACIÓN.

Modular

Design by Àlex Armenter



LEGS SET FOR 70 CM HIGH UNITS
CONJUNTO PIES PARA MUEBLES DE 70 CM ALTO

3410728

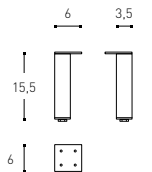

INCH 2.4x1.4x6.1



LEGS SET FOR 50 CM HIGH WITH COUNTER-TOP
WASHBASINS UNITS
CONJUNTO PIES PARA MUEBLES DE 50 CM DE ALTO
CON LAVABOS DE SOBRE-ENCIMERA

3410727

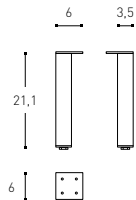

INCH 2.4x1.4x8.3



LEGS SET FOR 50 CM HIGH WITH BUILT IN
OR FITTED WASHBASINS UNITS
CONJUNTO PIES PARA MUEBLES DE 50 CM DE ALTO CON
ENCIMERAS CON LAVABOS CONTINUOS O ENCASTRADOS

3410726

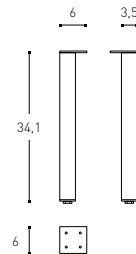

INCH 2.4x1.4x13.4



CONTAINER SUSPENDIDO
CONTAINER SUSPENDIDO

744 34 02
SMOKED / FUMÉ

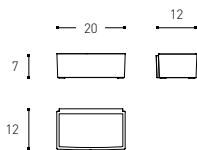

INCH 7.9x4.7x2.7



CONTAINER
CONTAINER

34190 15
SMOKED / FUMÉ

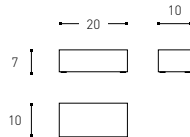

INCH 7.9x3.9x2.7



HANGING WASTEBASKET
PAPELERA SUSPENDIDA

744 34 04
SMOKED / FUMÉ

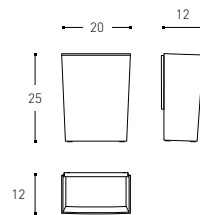

INCH 7.9x4.7x9.8

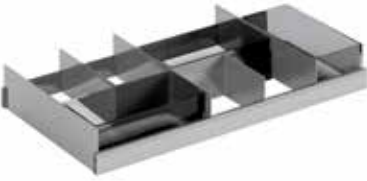

UPPER DRAWER DIVIDER SET ADDITIONAL UNITS
KIT SEPARADORES CAJON SUPERIOR MUEBLES AUXILIARES

45 CM / INCH 17.7

- 744 67 13**
50 CM / INCH 19.7
2 METHALIC DIVIDER + 2 CONTAINER
2 SEPARADORES + 2 CONTAINERS
- 744 67 14**
60 CM / INCH 23.6
2 METHALIC DIVIDER + 3 CONTAINER
2 SEPARADORES + 3 CONTAINERS
- 744 67 15**
80 CM / INCH 31.5
4 METHALIC DIVIDER + 4 CONTAINER
4 SEPARADORES + 4 CONTAINERS
- 744 67 16**
100 CM / INCH 39.4
6 METHALIC DIVIDER + 5 CONTAINER
6 SEPARADORES + 5 CONTAINERS



UPPER DRAWER DIVIDER SET ADDITIONAL UNITS
KIT SEPARADORES CAJON SUPERIOR MUEBLES AUXILIARES

55 CM / INCH 21.6

- 744 67 17**
50 CM / INCH 19.7
2 METHALIC DIVIDER + 3 CONTAINER
2 SEPARADORES + 3 CONTAINERS
- 744 67 18**
60 CM / INCH 23.6
2 METHALIC DIVIDER + 3 CONTAINER
2 SEPARADORES + 3 CONTAINERS
- 744 67 19**
80 CM / INCH 31.5
4 METHALIC DIVIDER + 4 CONTAINER
4 SEPARADORES + 4 CONTAINERS
- 744 67 20**
100 CM / INCH 39.4
6 METHALIC DIVIDER + 3 CONTAINER
6 SEPARADORES + 3 CONTAINERS



ADDITIONAL FRONT COVER
TAPETA LATERAL

- 744 000 AAA 00 00 0 00**
PVC
- 744 000 BBB 00 00 0 00**
MATTE / MATE
- 744 000 CCC 00 00 0 00**
GLOSSY / BRILLO

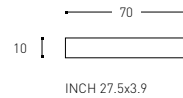

LOWER DRAWER CONTAINER
CONTAINER PARA CAJON INFERIOR

- 744 67 30**
40 CM / INCH 15.7
- 744 67 31**
50 CM / INCH 19.7
- 744 67 32**
60 CM / INCH 23.6
- 744 67 33**
80 CM / INCH 31.5
- 744 67 34**
100 CM / INCH 39.4

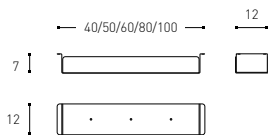



Modular offers three types of countertop: continuous countertops with a built in sink, only available in Cristalplant®; countertops (in Cristalplant®, vitrified steel or phenolic resin) adapted for combination with our washbasins made of vitrified steel; and countertops (available in all three materials) which are equipped to install our Modular above-counter sinks. The three countertops are suitable to cover a width range from 60 cm to 3 metres.

Modular ofrece tres tipos de encimera: encimeras continuas con seno integrado, sólo disponibles en Cristalplant®; encimeras (en Cristalplant®, acero vitrificado o resina fenólica) adaptadas para combinar con nuestros lavabos para encastrar de acero vitrificado; y encimeras (disponibles en los tres materiales) con la mecanización necesaria para instalar nuestros lavabos de sobre-encimera Modular. Las tres encimeras permiten cubrir anchos desde 60 cm hasta los 3 metros.

Cristalplant® a technologically advanced and unique compound, made up of high percentage of mineral extenders from nature (ATH derived from bauxite) as well as a small one of high-pureness polyester and acrylic polymers. Strongly UV-resistant.

Cristalplant®, material compuesto por un porcentaje elevado de minerales naturales (trihidrato de aluminio -ATH- derivado de la bauxita) y un bajo porcentaje de polímeros poliésteres y acrílicos de gran pureza. Óptima resistencia a los rayos ultravioletas.

PHENOLIC RESIN

5
YEARS
GUARANTEE
AÑOS
GARANTÍA

Phenolic Resin: Synthetic thermosetting resin, very resistant to heat and water (5 year guarantee).

Resina Fenólica: resina sintética termoestable muy resistente al calor y al agua (garantía de 5 años).



High safety tempered glass.

Vidrio templado de alta seguridad.



Modular

Design by Àlex Armenter

CODE / CODIFICACIÓN

74_	11	07	1	1	00	0900	CRISTALPLANT CRISTALPLANT
74_	AA	07	1	1	00	0900	RESIN RESINA
74_	BB	07	1	1	00	0900	GLASS VIDRIO
COLLECTION COLECCIÓN	FINISH ACABADO	DEPTH PROFUNDIDAD 45 CM: 07 55 CM: 09	NUMBER OF SINKS NÚMERO DE SENOS (0, 1, 2, 3...)	NUMBER OF TAP HOLES NÚMERO DE AGUJEROS PARA GRIFERÍA (0, 1, 2...)	UPSTAND COPETE (00, 01)	COUNTER SIZES IN MM MEDIDAS ENCIMERAS EN MM (0600-3000)	

FINISHES / ACABADOS

11

CRISTALPLANT



11
MATTE WHITE CRISTALPLANT
CRISTALPLANT BLANCO MATE

AA

RESIN / RESINA



07
MATTE WHITE RESIN
RESINA BLANCO MATE



08
MATTE BLACK RESIN
RESINA NEGRO MATE

BB

GLASS / VIDRIO



09
GLOSSY WHITE GLASS
VIDRIO BLANCO BRILLO

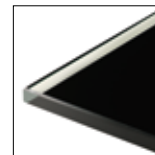

10
GLOSSY BLACK GLASS
VIDRIO NEGRO BRILLO

Counter top | Encimeras

WITH BUILT IN WASHBASIN | CON LAVABO INTEGRADO



CRISTALPLANT COUNTER TOP WITH 1 SINK
ENCIMERA CRISTALPLANT 1 SENSO

DEPTH / PROFUNDIDAD
(45 CM / INCH 17.7)
74C 11 07 1_00
MIN. 600 MM - MAX. 2.700 MM

DEPTH / PROFUNDIDAD
(55 CM / INCH 21.6)
74C 11 09 1_00
MIN. 800 MM - MAX. 2.700 MM

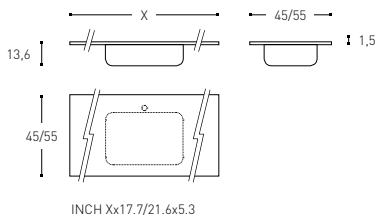

CRISTALPLANT COUNTER TOP WITH 2 SINKS
ENCIMERA CRISTALPLANT 2 SENOS

DEPTH / PROFUNDIDAD
(45 CM / INCH 17.7)
74C 11 07 2_00
MIN. 1200 MM - MAX. 2.700 MM

DEPTH / PROFUNDIDAD
(55 CM / INCH 21.6)
74C 11 09 2_00
MIN. 1600 MM - MAX. 2.700 MM

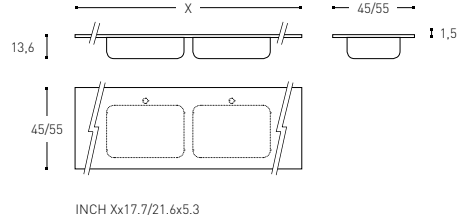

CRISTALPLANT COUNTER TOP WITH UPSTAND WITH 1 SINK
ENCIMERA CON COPETE CRISTALPLANT 1 SENSO

DEPTH / PROFUNDIDAD
(45 CM / INCH 17.7)
74C 11 07 1_01
MIN. 600 MM - MAX. 2.700 MM

DEPTH / PROFUNDIDAD
(55 CM / INCH 21.6)
74C 11 09 1_01
MIN. 800 MM - MAX. 2.700 MM

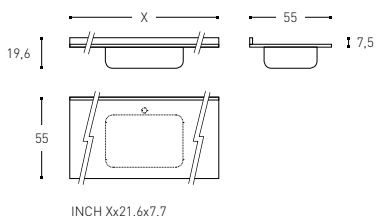

*
UPSTAND TILL 20 CM TALL CAN BE CUSTOM ORDERED
COPETE DE HASTA 20 CM DE ALTURA BAJO PEDIDO

CRISTALPLANT COUNTER TOP WITH UPSTAND WITH 2 SINKS
ENCIMERA CON COPETE CRISTALPLANT 2 SENOS

DEPTH / PROFUNDIDAD
(45 CM / INCH 17.7)
74C 11 07 2_01
MIN. 1200 MM - MAX. 2.700 MM

DEPTH / PROFUNDIDAD
(55 CM / INCH 21.6)
74C 11 09 2_01
MIN. 1600 MM - MAX. 2.700 MM

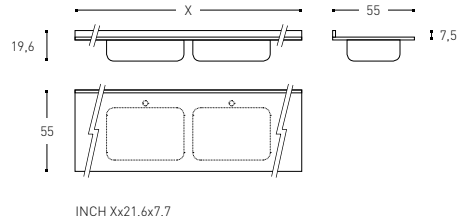

*
UPSTAND TILL 20 CM TALL CAN BE CUSTOM ORDERED
COPETE DE HASTA 20 CM DE ALTURA BAJO PEDIDO

Modular

Design by Àlex Armenter

FOR COUNTER-TOP WASHBASIN | PARA LAVABO SOBRE-ENCIMERA



●
CRISPLANT COUNTER TOP
ENCIMERA CRISPLANT

DEPTH / PROFUNDIDAD
(45 CM / INCH 17.7)
74S 11 07 _ 00 _ _ _ _
MIN. 600 MM - MAX. 3.000 MM

DEPTH / PROFUNDIDAD
(55 CM / INCH 21.6)
74S 11 09 _ 00 _ _ _ _
MIN. 600 MM - MAX. 3.000 MM

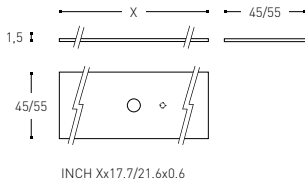

●
PHENOLIC RESIN COUNTER TOP
ENCIMERA RESINA FENÓLICA

DEPTH / PROFUNDIDAD
(45 CM / INCH 17.7)
74S AA 07 _ 00 _ _ _ _
MIN. 600 MM - MAX. 3.000 MM

DEPTH / PROFUNDIDAD
(55 CM / INCH 21.6)
74S AA 09 _ 00 _ _ _ _
MIN. 600 MM - MAX. 3.000 MM

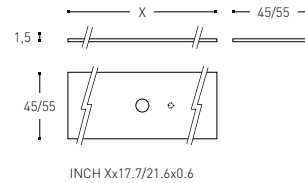

●
CRISPLANT COUNTER TOP WITH UPSTAND
ENCIMERA CON COPETE CRISPLANT

DEPTH / PROFUNDIDAD
(45 CM / INCH 17.7)
74S 11 07 _ 01 _ _ _ _ *
MIN. 600 MM - MAX. 3.000 MM

DEPTH / PROFUNDIDAD
(55 CM / INCH 21.6)
74S 11 09 _ 01 _ _ _ _ *
MIN. 600 MM - MAX. 3.000 MM

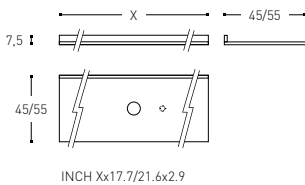

*
UPSTAND TILL 20 CM TALL CAN BE CUSTOM ORDERED
COPETE DE HASTA 20 CM DE ALTURA BAJO PEDIDO

●
PHENOLIC RESIN COUNTER TOP WITH UPSTAND
ENCIMERA CON COPETE RESINA FENÓLICA

DEPTH / PROFUNDIDAD
(45 CM / INCH 17.7)
74S AA 07 _ 01 _ _ _ _ *
MIN. 600 MM - MAX. 3.000 MM

DEPTH / PROFUNDIDAD
(55 CM / INCH 21.6)
74S AA 09 _ 01 _ _ _ _ *
MIN. 600 MM - MAX. 3.000 MM

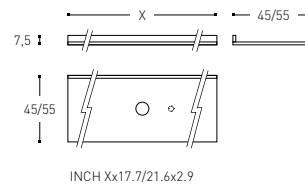

*
UPSTAND TILL 20 CM TALL CAN BE CUSTOM ORDERED
COPETE DE HASTA 20 CM DE ALTURA BAJO PEDIDO

COUNTER WITH SINK MECHANISING PROCESS
MECANIZADO ENCIMERA CON SENO

ADDITIONAL SINK MECHANISING PROCESS
MECANIZADO SENO ADICIONAL

COUNTER MECHANISING PROCESS WITHOUT SINK
MECANIZADO ENCIMERA SIN SENO

COUNTER WITH SINK MECHANISING PROCESS
MECANIZADO ENCIMERA CON SENO

ADDITIONAL SINK MECHANISING PROCESS
MECANIZADO SENO ADICIONAL

Counter top | Encimeras

FOR COUNTER-TOP WASHBASIN | PARA LAVABO SOBRE-ENCIMERA



◆
GLASS COUNTER TOP
ENCIMERA VIDRIO

DEPTH / PROFUNDIDAD
(45 CM / INCH 17.7)

74S BB 07 _ _ 00 _ _ _ _
MIN. 600 MM - MAX. 3.000 MM

DEPTH / PROFUNDIDAD
(55 CM / INCH 21.6)

74S BB 09 _ _ 00 _ _ _ _
MIN. 600 MM - MAX. 3.000 MM

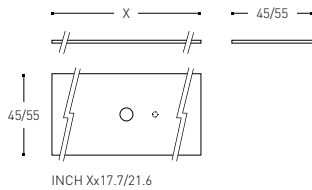

COUNTER MECHANISING PROCESS WITHOUT SINK
MECANIZADO ENCIMERA SIN SENO

COUNTER WITH SINK MECHANISING PROCESS
MECANIZADO ENCIMERA CON SENO

ADDITIONAL SINK MECHANISING PROCESS
MECANIZADO SENO ADICIONAL



Modular

Design by Àlex Armenter

FOR BUILT-IN WASHBASIN | PARA LAVABO ENCASTRADO



●
CRISTALPLANT COUNTER TOP
ENCIMERA CRISTALPLANT

DEPTH / PROFUNDIDAD
(45 CM / INCH 17.7)
744 11 07 _ 00 _ _ _ _
MIN. 600 MM - MAX. 3.000 MM

DEPTH / PROFUNDIDAD
(55 CM / INCH 21.6)
744 11 09 _ 00 _ _ _ _
MIN. 600 MM - MAX. 3.000 MM

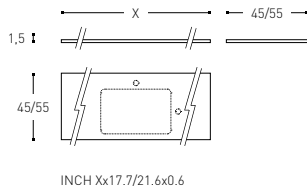

●
PHENOLIC RESIN COUNTER TOP
ENCIMERA RESINA FENÓLICA

DEPTH / PROFUNDIDAD
(45 CM / INCH 17.7)
744 AA 07 _ 00 _ _ _ _
MIN. 600 MM - MAX. 3.000 MM

DEPTH / PROFUNDIDAD
(55 CM / INCH 21.6)
744 AA 09 _ 00 _ _ _ _
MIN. 600 MM - MAX. 3.000 MM

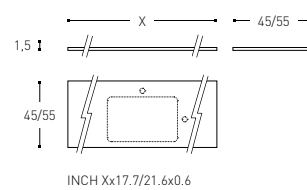

●
CRISTALPLANT COUNTER TOP WITH UPSTAND
ENCIMERA CON COPETE CRISTALPLANT

DEPTH / PROFUNDIDAD
(45 CM / INCH 17.7)
744 11 07 _ 01 _ _ _ _ *
MIN. 600 MM - MAX. 3.000 MM

DEPTH / PROFUNDIDAD
(55 CM / INCH 21.6)
744 11 09 _ 01 _ _ _ _ *
MIN. 600 MM - MAX. 3.000 MM

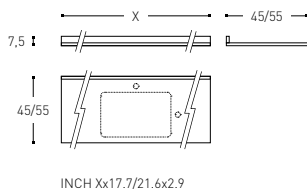

*
UPSTAND TILL 20 CM TALL CAN BE CUSTOM ORDERED
COPETE DE HASTA 20 CM DE ALTURA BAJO PEDIDO

●
PHENOLIC RESIN COUNTER TOP WITH UPSTAND
ENCIMERA CON COPETE RESINA FENÓLICA

DEPTH / PROFUNDIDAD
(45 CM / INCH 17.7)
744 AA 07 _ 01 _ _ _ _ *
MIN. 600 MM - MAX. 3.000 MM

DEPTH / PROFUNDIDAD
(55 CM / INCH 21.6)
744 AA 09 _ 01 _ _ _ _ *
MIN. 600 MM - MAX. 3.000 MM

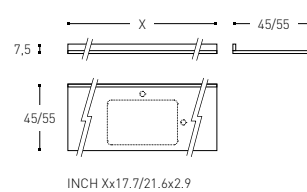

*
UPSTAND TILL 20 CM TALL CAN BE CUSTOM ORDERED
COPETE DE HASTA 20 CM DE ALTURA BAJO PEDIDO

COUNTER WITH SINK MECHANISING PROCESS
MECANIZADO ENCIMERA CON SENO

ADDITIONAL SINK MECHANISING PROCESS
MECANIZADO SENO ADICIONAL

COUNTER MECHANISING PROCESS WITHOUT SINK
MECANIZADO ENCIMERA SIN SENO

COUNTER WITH SINK MECHANISING PROCESS
MECANIZADO ENCIMERA CON SENO

ADDITIONAL SINK MECHANISING PROCESS
MECANIZADO SENO ADICIONAL

Counter top | Encimeras

FOR BUILT-IN WASHBASIN | PARA LAVABO ENCASTRADO



◆
GLASS COUNTER TOP
ENCIMERA VIDRIO

DEPTH / PROFUNDIDAD
(45 CM / INCH 17.7)
744 BB 07 _ _ 00 _ _ _ _
MIN. 600 MM - MAX. 3.000 MM

DEPTH / PROFUNDIDAD
(55 CM / INCH 21.6)
744 BB 09 _ _ 00 _ _ _ _
MIN. 600 MM - MAX. 3.000 MM

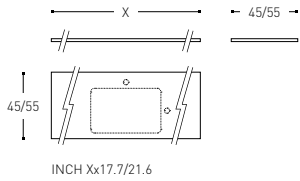

● ●
LATERAL UPSTAND
COPETE LATERAL

744 11 01*
MATTE WHITE CRISTALPLANT
CRISTALPLANT BLANCO MATE

744 07 01*
MATTE WHITE RESIN
RESINA BLANCO MATE

744 09 01*
MATTE BLACK RESIN
RESINA NEGRO MATE

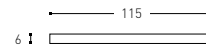

INCH 45.3x2.4x0.6

*
UPSTAND TILL 20 CM TALL CAN BE CUSTOM ORDERED
COPETE DE HASTA 20 CM DE ALTURA BAJO PEDIDO

COUNTER MECHANISING PROCESS WITHOUT SINK
MECANIZADO ENCIMERA SIN SENO

COUNTER WITH SINK MECHANISING PROCESS
MECANIZADO ENCIMERA CON SENO

ADDITIONAL SINK MECHANISING PROCESS
MECANIZADO SENO ADICIONAL





Counter-top washbasins that are 13cm high, made of Cristalplant®. Available in three different shapes: round, square and rectangular.

Lavabos de sobre-encimera con una altura de 13 cm y realizados en Cristalplant®. Disponibles en tres formas: redonda, cuadrada y rectangular.

Cristalplant® a technologically advanced and unique compound, made up of high percentage of mineral extenders from nature (ATH derived from bauxite) as well as a small one of high-pureness polyester and acrylic polymers. Strongly UV-resistant.

Cristalplant®, material compuesto por un porcentaje elevado de minerales naturales (trihidrato de aluminio -ATH- derivado de la bauxita) y un bajo porcentaje de polímeros poliésteres y acrílicos de gran pureza. Óptima resistencia a los rayos ultravioletas.

CRISTALPLANT

5

YEARS
GUARANTEE
AÑOS
GARANTÍA



Built-in washbasins, available in white or black with matte or glossy finishes. Pieces with deep sink, avoiding splashing.

Lavabos encastrados disponibles en blanco o negro con acabados mate o brillo. Piezas con seno profundo que evita salpicaduras.

Vit-tech: top quality glass-lined steel (10 year guarantee). Material 100% recyclable. High chemical, mechanic and corrosion resistance. Easy clean.

Vit-tech: acero vitrificado de alta calidad (garantía 10 años). Material 100% Reciclable. Alta resistencia química, mecánica y a la corrosión. Fácil limpieza.

VIT-TECH | **10**
YEARS
GUARANTEE
AÑOS
GARANTÍA



Modular

Design by Àlex Armenter

CODE / CODIFICACIÓN

744 11 06 01 CRISTALPLANT

744 AA 00 00 VIT-TECH

COLLECTION
COLECCIÓN

FINISH
ACABADO

TYPE
MODELO

FINISHES / ACABADOS

11

CRISTALPLANT



11
MATTE WHITE
BLANCO MATE

AA

VIT-TECH



03
GLOSSY WHITE
BLANCO BRILLO



04
MATTE WHITE
BLANCO MATE



05
GLOSSY BLACK
NEGRO BRILLO



06
MATTE BLACK
NEGRO MATE

Washbasins | Lavabos



●
COUNTERTOP WASHBASIN
 LAVABO DE SOBRE-ENCIMERA

744 11 06 01

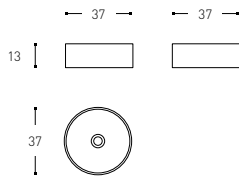

INCH 14.6x14.6x5.1



●
COUNTERTOP WASHBASIN
 LAVABO DE SOBRE-ENCIMERA

744 11 06 02

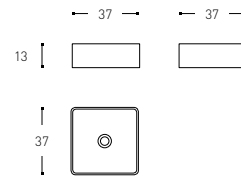

INCH 14.6x14.6x5.1



●
COUNTERTOP WASHBASIN
 LAVABO DE SOBRE-ENCIMERA

744 11 10 03

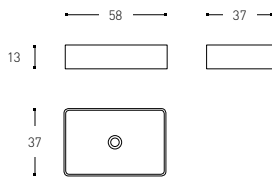

INCH 22.8x14.6x5.1



●
WASHBASIN
 LAVABO

744 03 00 00
 GLOSSY WHITE / BLANCO BRILLO
744 AA 00 00
 MATTE WHITE / BLANCO MATE
 GLOSSY BLACK / NEGRO BRILLO
 MATTE BLACK / NEGRO MATE

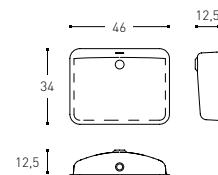

INCH 18.1x4.9x13.4

Modular

Design by Àlex Armenter



KIT VALVE & OVERFLOW TANK FLANGE
FOR BUILT-IN WASHBASINS
KIT VÁLVULA Y EMBELLECEDOR REBOSADERO
PARA LAVABOS DE ENCASTRAR

34105 58
CHROME / CROMO

34105 65
MATTE WHITE-CHROME / BLANCO MATE-CROMO

34105 66
GLOSSY WHITE / BLANCO BRILLO

34105 67
MATTE BLACK / NEGRO MATE

34105 68
GLOSSY BLACK / NEGRO BRILLO

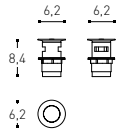

INCH 2.4x2.4x3.3



FREE DRAIN VALVE
FOR COUNTERTOP WASHBASIN
VÁLVULA DESCARGA LIBRE
PARA LAVABO DE SOBRE-ENCIMERA

34076 00
CHROME / CROMO

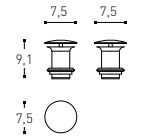

INCH 2.9x2.9x3.6



TRAP
SIFÓN

34105 90

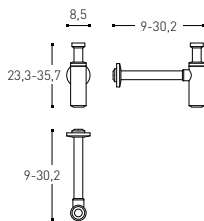

INCH 3.3x3.5-11.9x9.2-14

Washbasins | Lavabos





Mirror Cabinets with or without a light and a socket. Built in bottom handle. Inside shelves made of adjustable glass.

Armarios espejo con y sin luz y enchufe. Tirador inferior integrado. Estantes interiores de vidrio regulables.



Available in three different widths. Cabinets with a width of 40 or 50 cm fitted with a 24w light. Cabinets with a width of 60 cm fitted with a 40 w light. PVC or lacquered matte finish.

Disponibles en tres medidas de ancho. Los de 40 y 50 cm con luz tienen potencia de 24 w. Los de 60 cm con luz, tienen 40 w de potencia. Acabados en PVC o lacado mate.

Medicine cabinets | Armarios espejo

CODE / CODIFICACIÓN

744 AAA 000 00 08 A 04

PVC STRUCTURE
CUERPO PVC

744 BBB 000 00 08 A 04

MATTE STRUCTURE
CUERPO MATE

COLLECTION
COLECCIÓN

STRUCTURE COLOUR
COLOR CUERPO

TYPE
MODELO

FINISHES / ACABADOS

AAA

PVC

STRUCTURE COLOUR
COLOR CUERPO



129
MATTE WHITE
BLANCO MATE



130
MATE ANTHRACITE
ANTRACITA MATE

BBB

MATTE LACQUERED / LACADO MATE

STRUCTURE COLOUR
COLOR CUERPO



102
MATE WHITE
BLANCO MATE



104
MATTE LIGHT GREY
GRIS CLARO MATE



110
MATTE LIGHT CREAM
CREMA LIGHT MATE



140
MATTE OLIVE GREY
GRIS OLIVA MATE



112
MATTE MINK
VISÓN MATE



106
MATTE AMETHYST
GREY
GRIS AMATISTA MATE



114
MATTE CHOCOLATE
CHOCOLATE MATE



108
MATTE BLACK
NEGRO MATE



116
MATTE GREEN
VERDE MATE



126
MATTE BLUE
AZUL MATE



124
MATTE AUBERGINE
BERENJENA MATE



122
MATTE PINK
ROSA MATE



120
MATTE RUBY
RUBÍ MATE



118
MATTE ORANGE
NARANJA MATE



128
MATTE METALLIC GREY
GRIS METALIZADO
MATE



Modular

Design by Àlex Armenter



◆ ■ □
MEDICINE CABINET
 ARMARIO ESPEJO
 40 CM / INCH 15.7

- ☞ **744 AAA 000 00 06 A 04**
PVC / PVC
- ☞ **744 AAA 000 00 06 A 02**
PVC / PVC
- ☞ **744 BBB 000 00 06 A 04**
MATTE LACQUERED / LACADO MATE
- ☞ **744 BBB 000 00 06 A 02**
MATTE LACQUERED / LACADO MATE

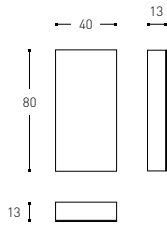

INCH 15.7x5.1x31.5



◆ ■ □
MEDICINE CABINET
 ARMARIO ESPEJO
 50 CM / INCH 19.7

- ☞ **744 AAA 000 00 08 A 04**
PVC / PVC
- ☞ **744 AAA 000 00 08 A 02**
PVC / PVC
- ☞ **744 BBB 000 00 08 A 04**
MATTE LACQUERED / LACADO MATE
- ☞ **744 BBB 000 00 08 A 02**
MATTE LACQUERED / LACADO MATE

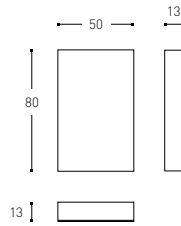

INCH 19.7x5.1x31.5



◆ ■ □
MEDICINE CABINET
 ARMARIO ESPEJO
 60 CM / INCH 23.6

- ☞ **744 AAA 000 00 10 A 04**
PVC / PVC
- ☞ **744 AAA 000 00 10 A 02**
PVC / PVC
- ☞ **744 BBB 000 00 10 A 04**
MATTE LACQUERED / LACADO MATE
- ☞ **744 BBB 000 00 10 A 02**
MATTE LACQUERED / LACADO MATE

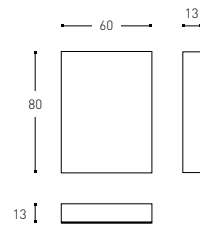

INCH 23.6x5.1x31.5



◆ ■ □
MEDICINE CABINET WITH LIGHTING
 ARMARIO ESPEJO CON LUZ
 40 CM / INCH 15.7
 [1XTC-L 24W IP44 CE]

- ☞ **744 AAA 000 00 06 A 06**
PVC / PVC
- ☞ **744 AAA 000 00 06 A 05**
PVC / PVC
- ☞ **744 BBB 000 00 06 A 06**
MATTE LACQUERED / LACADO MATE
- ☞ **744 BBB 000 00 06 A 05**
MATTE LACQUERED / LACADO MATE

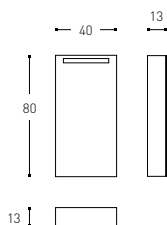

INCH 15.7x5.1x31.5



◆ ■ □
MEDICINE CABINET WITH LIGHTING
 ARMARIO ESPEJO CON LUZ
 50 CM / INCH 19.7
 [1XTC-L 24W IP44 CE]

- ☞ **744 AAA 000 00 08 A 06**
PVC / PVC
- ☞ **744 AAA 000 00 08 A 05**
PVC / PVC
- ☞ **744 BBB 000 00 08 A 06**
MATTE LACQUERED / LACADO MATE
- ☞ **744 BBB 000 00 08 A 05**
MATTE LACQUERED / LACADO MATE

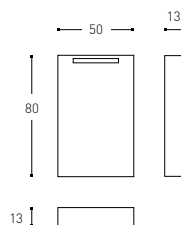

INCH 19.7x5.1x31.5



◆ ■ □
MEDICINE CABINET WITH LIGHTING
 ARMARIO ESPEJO CON LUZ
 60 CM / INCH 23.6
 [1XTC-L 24W IP44 CE]

- ☞ **744 AAA 000 00 10 A 06**
PVC / PVC
- ☞ **744 AAA 000 00 10 A 05**
PVC / PVC
- ☞ **744 BBB 000 00 10 A 06**
MATTE LACQUERED / LACADO MATE
- ☞ **744 BBB 000 00 10 A 05**
MATTE LACQUERED / LACADO MATE

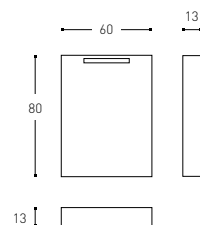

INCH 23.6x5.1x31.5



MEDICINE CABINET WITH LIGHTING & SOCKET
 ARMARIO ESPEJO CON LUZ Y ENCHUFE

40 CM / INCH 15.7
 [1XTC-L 24W IP44 CE]

- 744 AAA 000 00 06 A 03**
PVC / PVC
- 744 AAA 000 00 06 A 01**
PVC / PVC
- 744 BBB 000 00 06 A 03**
MATTE LACQUERED / LACADO MATE
- 744 BBB 000 00 06 A 01**
MATTE LACQUERED / LACADO MATE

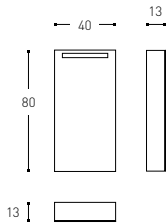

INCH 15.7x5.1x31.5



MEDICINE CABINET WITH LIGHTING & SOCKET
 ARMARIO ESPEJO CON LUZ Y ENCHUFE

50 CM / INCH 19.7
 [1XTC-L 24W IP44 CE]

- 744 AAA 000 00 08 A 03**
PVC / PVC
- 744 AAA 000 00 08 A 01**
PVC / PVC
- 744 BBB 000 00 08 A 03**
MATTE LACQUERED / LACADO MATE
- 744 BBB 000 00 08 A 01**
MATTE LACQUERED / LACADO MATE

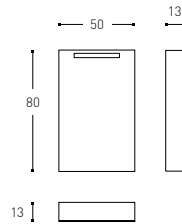

INCH 19.7x5.1x31.5



MEDICINE CABINET WITH LIGHTING & SOCKET
 ARMARIO ESPEJO CON LUZ Y ENCHUFE

60 CM / INCH 23.6
 [1XTC-L 24W IP44 CE]

- 744 AAA 000 00 10 A 03**
PVC / PVC
- 744 AAA 000 00 10 A 01**
PVC / PVC
- 744 BBB 000 00 10 A 03**
MATTE LACQUERED / LACADO MATE
- 744 BBB 000 00 10 A 01**
MATTE LACQUERED / LACADO MATE

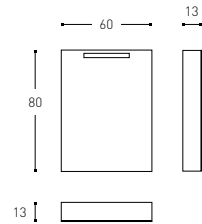

INCH 23.6x5.1x31.5



Modular Plan

www.icosmic.com

With **Modular Plan** you can try out multiple combinations until you find something that really corresponds with the tastes or needs of your clients. Please see some examples below of combinations that you can use as a guide. We would like to invite you to take a look at our website (www.icosmic.com) and to use Modular Plan. It is a finely honed tool that offers a comprehensive range of products to create different environments: washbasins, furniture, faucets, mirrors and lighting. modular plan.

Con **Modular Plan** podrá realizar múltiples combinaciones hasta encontrar la que realmente se acomode a los gustos o necesidades de sus clientes. A continuación presentamos unos ejemplos de conjuntos que le pueden servir de guía. Le invitamos a que acceda a nuestra web (www.icosmic.com) y que utilice Modular Plan. Es una herramienta ágil que contiene una completa gama de producto para diseñar sus ambientes: lavabos, mobiliario, griferías, espejos e iluminación.



Modular Plan is a new planning tool designed to configure the bathroom space with the innovative Modular furniture system. This new tool enables you to experiment by combining deeps, sizes and colours until you find the perfect solution for your customers' needs and tastes. For full information and to aid sales, Modular Plan can provide a completely personalised quotation.

Modular Plan es una herramienta de planificación muy útil diseñada para la configuración del espacio del baño con el sistema de mobiliario Modular. Con esta herramienta usted podrá experimentar combinando profundidades, medidas y colores hasta encontrar la solución perfecta a las necesidades y gustos de sus clientes. Para completar la información y facilitarle la venta, Modular Plan le permite obtener un presupuesto totalmente personalizado.



WHAT DOES MODULAR PLAN GIVE YOU?

- An easy, flexible and intuitive method that enables you to create as many bathroom compositions as you wish.
- A full product range to design your ambiances: washbasins, unit, taps, mirrors and lighting.
- A customised layout.
- Possibility of personalising your bathroom space with different sizes, depths, material, colours and accessories.
- Space creations with plan and elevation views.
- Final quotation of your composition and price of each piece selected.
- Full information in 7 languages: Spanish, Portuguese, English, French, Italian, German and Dutch.

¿QUÉ LE OFRECE MODULAR PLAN?

- Una manera fácil, ágil e intuitiva que le permite crear tantas composiciones de baño como desee.
- Una completa gama de producto para diseñar sus ambientes: lavabos, mobiliario, griferías, espejos e iluminación.
- Configuración del espacio a su medida.
- Posibilidad de personalizar su espacio de baño con diferentes tamaños, profundidades, materiales, colores y complementos.
- Creación de espacios con vistas en planta y alzado.
- Presupuesto final de su composición y precio de cada una de las piezas seleccionadas.
- Toda la información en 7 idiomas: español, portugués, inglés, francés, italiano, alemán y holandés.

HOW DOES MODULAR PLAN WORK?

Modular Plan available in www.icosmic.com

- Access for final consumer. No prices.
- Access for authorised distributor with personal access key (provided by our sales team). Prices available.

¿CÓMO UTILIZAR MODULAR PLAN?

Pronto en nuestra página web www.icosmic.com

- Acceso para consumidor final. Sin precios.
- Acceso para distribuidor autorizado con clave de acceso personal (facilitada por nuestro equipo comercial). Tarifa disponible.

Modular

Design by Àlex Armenter

MODULAR 55

CRISTALPLANT COUNTERTOP WITH INTEGRATED SINK / ENCIMERA SENO INTEGRADO CRISTALPLANT

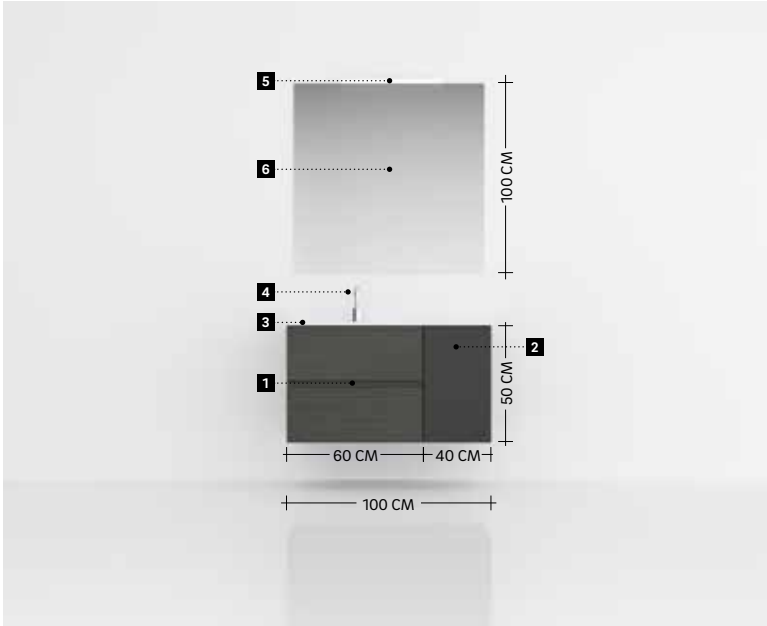

1	74N 130 132 10 10 3 12	1
2	74N 130 130 00 06 7 12	1
3	74C 11 09 11 00 1006	1
4	254 01 02	1
5	755 01 90	1
6	281 81 50	1

MODULAR 45

CRISTALPLANT COUNTERTOP WITH INTEGRATED SINK / ENCIMERA SENO INTEGRADO CRISTALPLANT

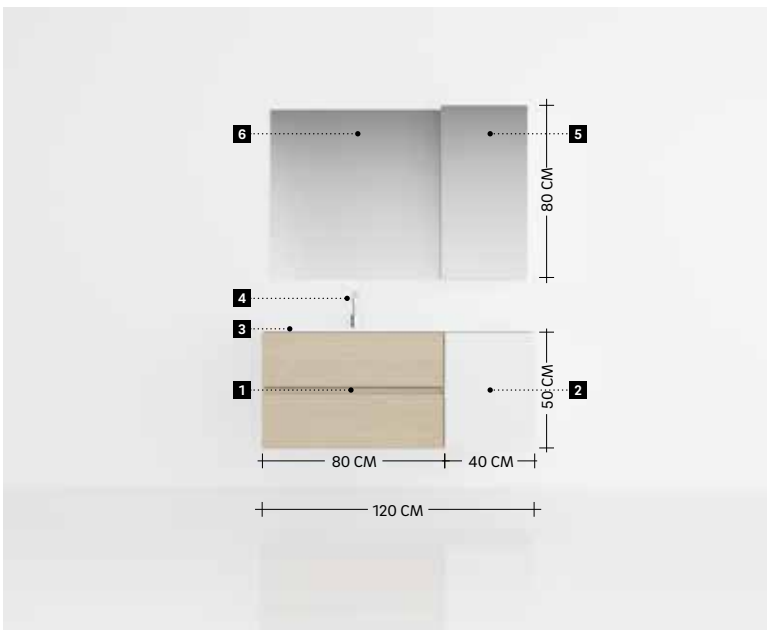

1	74N 129 131 10 14 3 11	1
2	74N 129 129 00 06 7 11	1
3	74C 11 07 11 00 1206	1
4	254 01 02	1
5	744 129 000 00 06 A 04	1
6	281 81 48	1



MODULAR 45

CRISTALPLANT COUNTERTOP WITH INTEGRATED SINK / ENCIMERA SENO INTEGRADO CRISTALPLANT

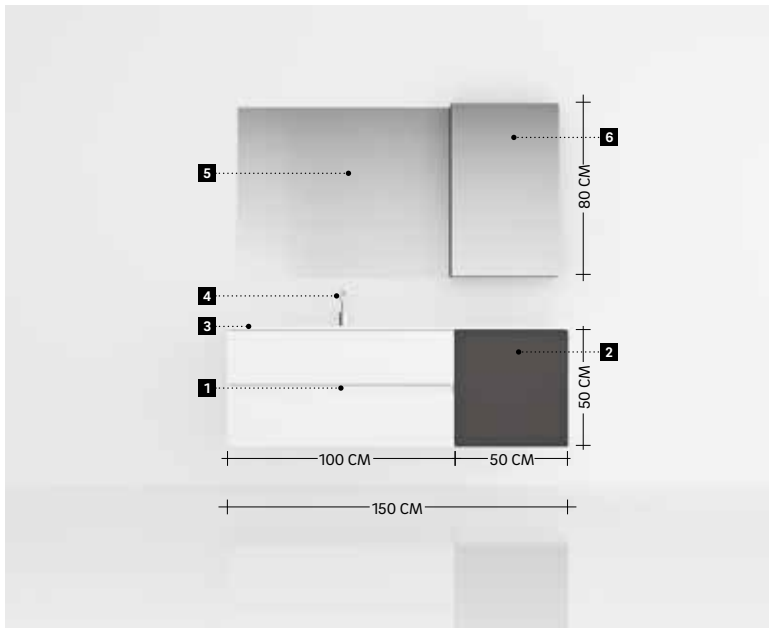

1	74N 129 129 10 18 3 11	1
2	74N 130 130 00 08 7 11	1
3	74C 11 07 11 00 15 06	1
4	254 01 02	1
5	281 81 49	1
6	744 130 000 00 08 A 02	1

MODULAR 55

CRISTALPLANT COUNTERTOP WITH INTEGRATED SINK / ENCIMERA SENO INTEGRADO CRISTALPLANT

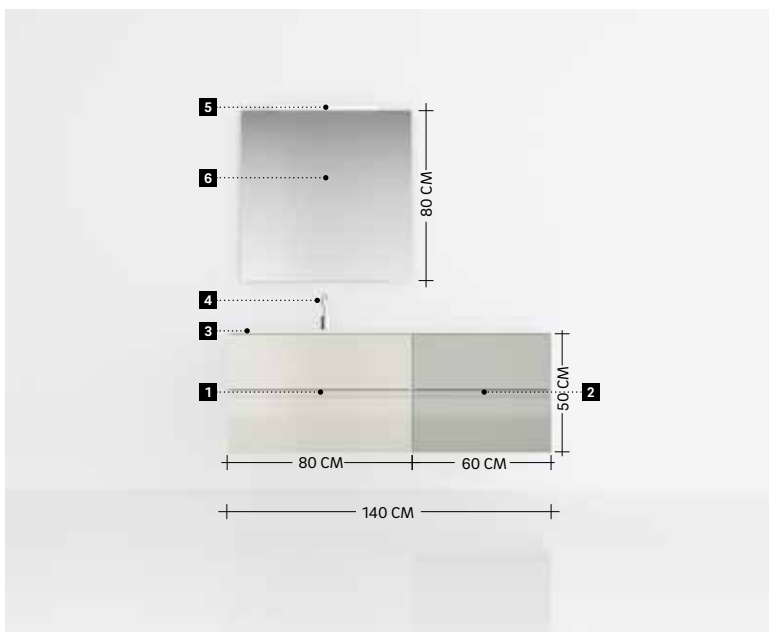

1	74N 140 139 10 14 3 12	1
2	74N 116 115 00 10 3 12	1
3	74C 11 09 11 00 14 06	1
4	254 01 02	1
5	755 01 90	1
6	281 81 48	1

Modular

Design by Àlex Armenter

MODULAR 45

CRISTALPLANT COUNTERTOP WITH 2 INTEGRATED SINKS / ENCIMERA 2 SENOS INTEGRADOS CRISTALPLANT

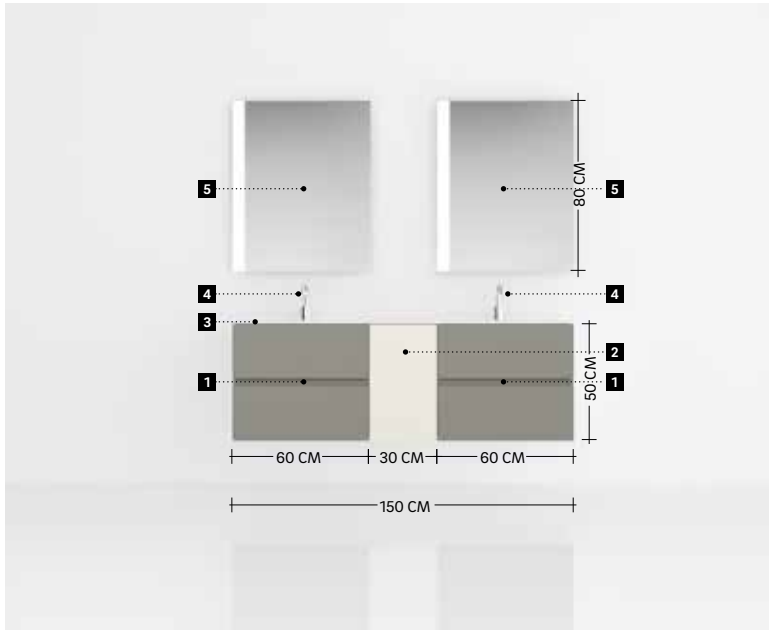

1	74N 129 112 10 10 3 11	2
2	74N 129 110 00 04 7 11	1
3	74C 11 07 2 2 00 1507	1
4	254 01 02	2
5	281 82 03	2

MODULAR 45

CRISTALPLANT COUNTERTOP WITH INTEGRATED SINK / ENCIMERA SENO INTEGRADO CRISTALPLANT

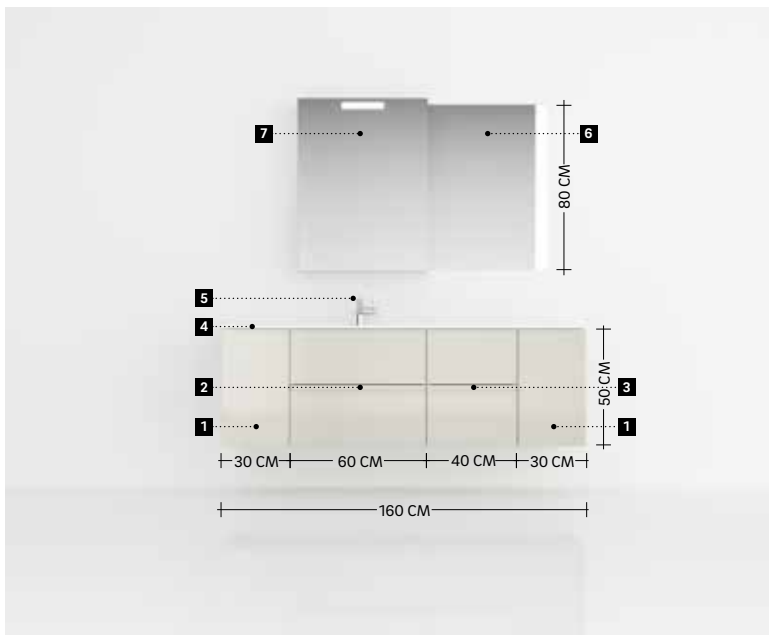

1	74N 140 139 00 04 7 11	2
2	74N 140 139 10 10 3 11	1
3	74N 140 139 00 06 3 11	1
4	74C 11 07 11 00 1608	1
5	248 01 02	1
6	281 82 03	1
7	744 140 000 00 10 A 06	1

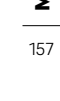

MODULAR 55

CRISTALPLANT COUNTERTOP WITH 2 INTEGRATED SINKS / ENCIMERA CRISTALPLANT 2 SENOS INTEGRADOS

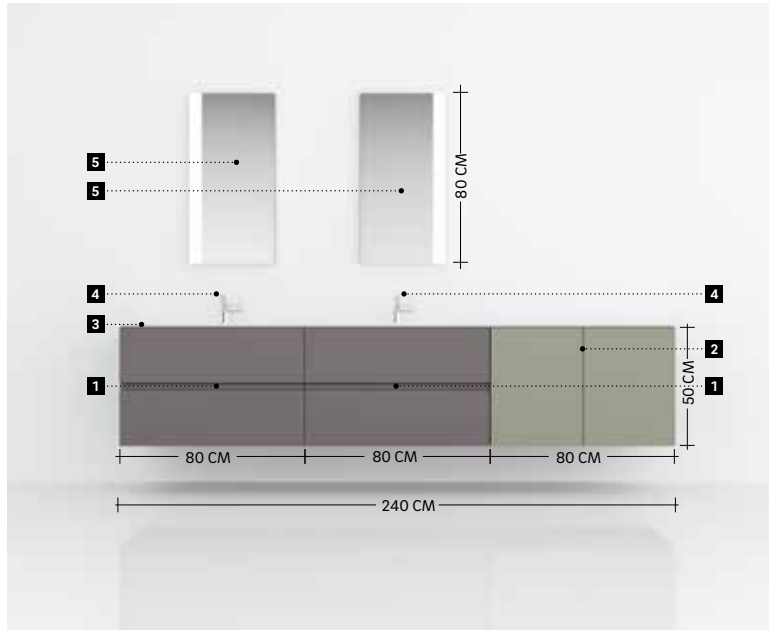

1	74N 106 106 10 14 3 12	2
2	74N 116 116 00 14 8 12	1
3	74C 11 09 2 2 00 2407	1
4	248 01 02	2
5	281 82 01	2

MODULAR 45

CRISTALPLANT COUNTERTOP FOR COUNTERTOP WASHBASIN / ENCIMERA CRISTALPLANT PARA LAVABO SOBRE-ENCIMERA

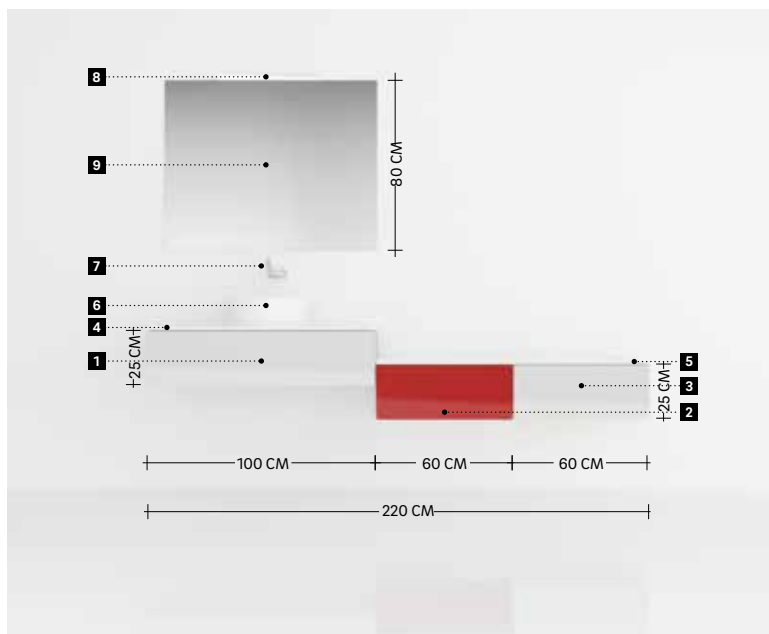

1	74N 104 103 10 18 2 21	1
2	74N 120 119 00 10 2 21	1
3	74N 104 103 00 10 2 21	1
4	74S 11 07 10 00 1005	1
5	744 11 07 00 00 1206	1
6	744 110 601	1
7	248 01 03	1
8	755 01 90	1
9	281 81 49	1

Modular

Design by Àlex Armenter

MODULAR 55

CRISTALPLANT COUNTERTOP FOR COUNTERTOP WASHBASIN / ENCIMERA CRISTALPLANT PARA LAVABO SOBRE-ENCIMERA

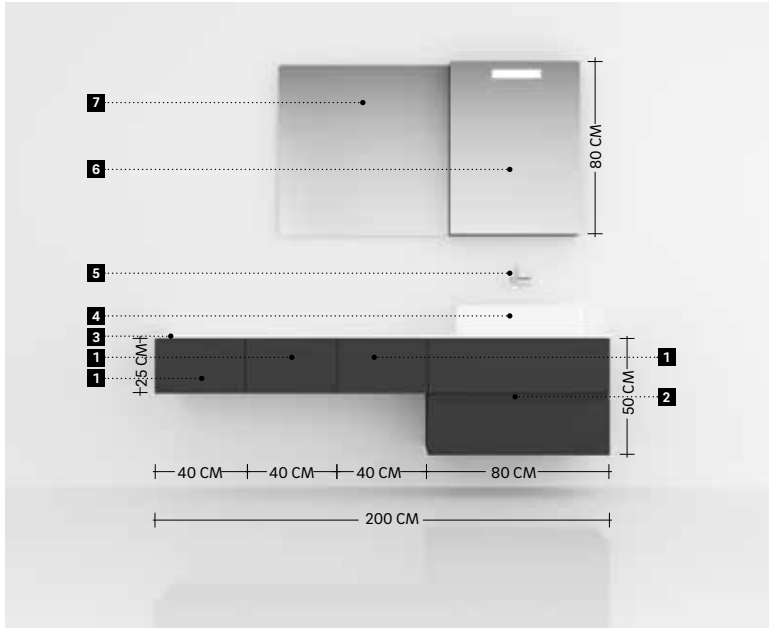

1	74N 108 108 00 06 2 22	3
2	74N 108 108 10 14 3 12	1
3	74S 11 09 10 00 2008	1
4	744 111 003	1
5	248 01 03	1
6	744 108 000 00 10 A 06	1
7	281 81 48	1

MODULAR 45

CRISTALPLAN COUNTERTOP FOR COUNTERTOP WASHBASIN / ENCIMERA CRISTALPLANT PARA LAVABO SOBRE-ENCIMERA

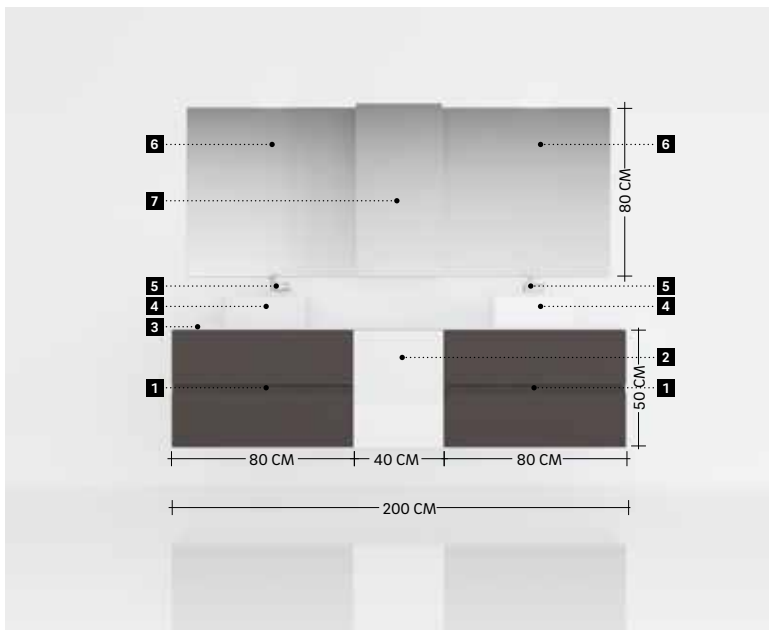

1	74N 102 114 10 14 3 11	2
2	74N 102 064 00 06 7 11	1
3	74S 11 07 2 0 00 2007	1
4	744 110 602	2
5	248 01 03	2
6	281 81 48	2
7	744 102 000 00 06 A 04	1

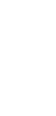

MODULAR 55

PHENOLIC RESIN COUNTERTOP FOR BUILT-IN WASHBASIN / ENCIMERA RESINA FENÓLICA PARA LAVABO ENCASTRADO

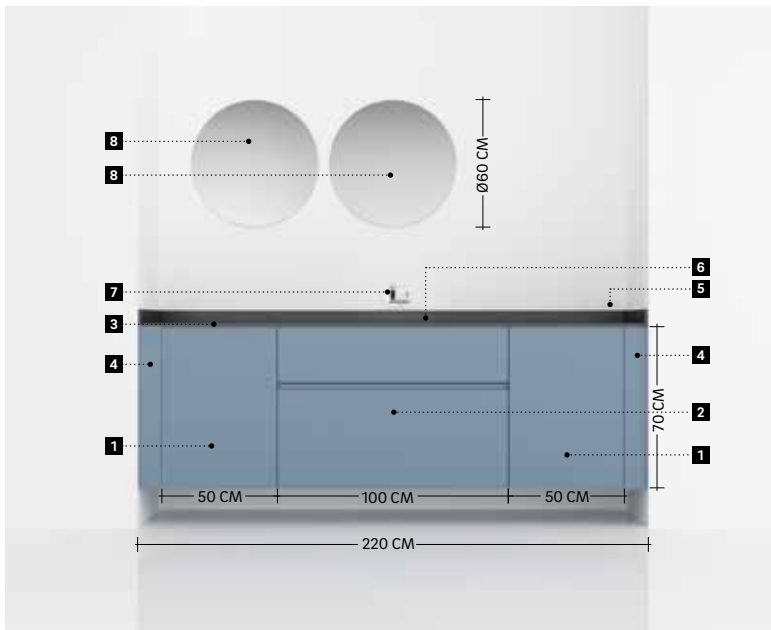

1	74N 126 126 00 08 7 04	2
2	74N 126 126 10 18 3 02	1
3	744 08 09 11 01 2195	1
4	744 000 126 00 00 0 00	2
5	744 09 01	1
6	744 06 00 00	1
7	248 01 03	1
8	281 81 41	2

MODULAR 55

GLASS COUNTERTOP FOR BUILT-IN WASHBASIN / ENCIMERA VIDRIO PARA LAVABO ENCASTRADO

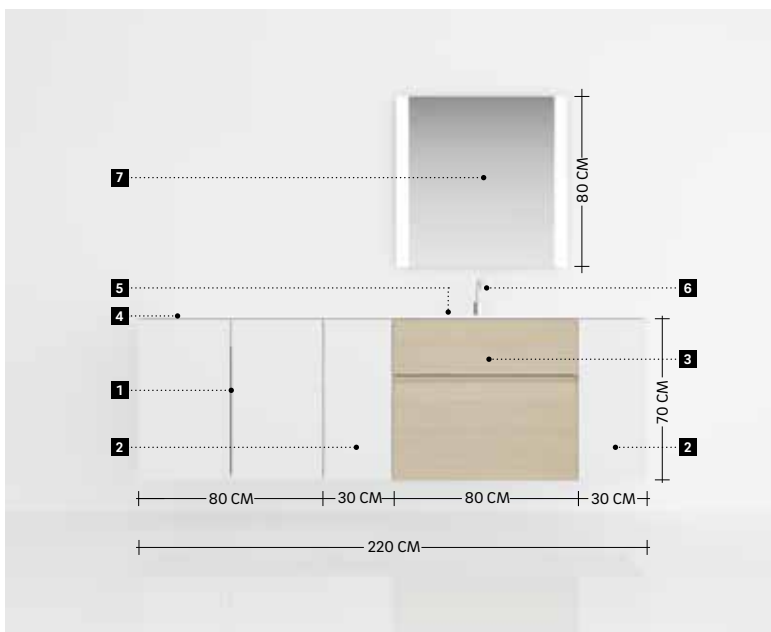

1	74N 129 129 00 14 8 02	1
2	74N 129 129 00 04 7 04	2
3	74N 129 131 10 14 3 02	1
4	744 09 09 11 00 2208	1
5	744 04 00 00	1
6	254 01 02	1
7	281 82 04	1

Modular

Design by Àlex Armenter

BASIN MOUNTING SET
ACCESORIO SUJECIÓN LAVABO

34190 26

SPARE PART OF / RECAMBIO DE
VIT-TECH WASHBASIN
LAVABOS VIT-TECH

TRAP
SIFÓN

34190 60

SPARE PART OF / RECAMBIO DE
50 OR 70 CM TALL CABINETS FOR WASHBASIN
MUEBLES PARA LAVABO DE 50 Y 70 CM DE ALTURA

34105 90

SPARE PART OF / RECAMBIO DE
25 CM TALL CABINETS FOR WASHBASIN
MUEBLES PARA LAVABO DE 25 CM DE ALTURA

OVERFLOW TANK
REBOSADERO

34190 61

SPARE PART OF / RECAMBIO DE
VIT-TECH WASHBASIN
LAVABOS VIT-TECH

34107 24

SPARE PART OF / RECAMBIO DE
COUNTER TOP WITH BUILT IN WASHBASIN
ENCIMERAS CON SENO INTEGRADO

FREE DRAIN VALVE
VÁLVULA DESCARGA LIBRE

340 76 00

CROMO / CROMO

SPARE PART OF / RECAMBIO DE
COUNTER-TOP WASHBASINS
LAVABOS DE SOBRE-ENCIMERA

POP-UP VALVE
VÁLVULA CLICK CLACK

34103 87

SPARE PART OF / RECAMBIO DE
VIT-TECH WASHBASIN
LAVABOS VIT-TECH

CRISTALPLANT COUNTER CLEANING SET
KIT DE LIMPIEZA ENCIMERA CRISTALPLANT

34102 95

SPARE PART OF / RECAMBIO DE
CRISTALPLANT COUNTER TOPS
ENCIMERAS DE CRISTALPLANT

CRISTALPLANT COUNTER REPAIRING KIT
KIT REPARACIÓN ENCIMERA CRISTALPLANT

34107 29

SPARE PART OF / RECAMBIO DE
CRISTALPLANT COUNTER TOPS
ENCIMERAS DE CRISTALPLANT

CABINET MOUNTING SET
ACCESORIO SUJECIÓN MUEBLE

34106 83

SPARE PART OF / RECAMBIO DE
25 OR 50 CM TALL CABINETS
MUEBLES DE 25 Y 50 CM DE ALTO

34104 46

SPARE PART OF / RECAMBIO DE
70 CM TALL CABINETS
MUEBLES DE 70 CM DE ALTO

UPPER DRAWER
CAJÓN SUPERIOR

(45 CM / INCH 17.7)

341 06 96
40x45 CM / INCH 15.7x17.7

341 06 98
50x45 CM / INCH 19.7x17.7

341 07 00
60x45 CM / INCH 23.6x17.7

341 07 02
80x45 CM / INCH 31.5x17.7

341 07 04
100x45 CM / INCH 39.4x17.7

(55 CM / INCH 21.6)

341 06 97
40x55 CM / INCH 15.7x21.6

341 06 99
50x55 CM / INCH 19.7x21.6

341 07 01
60x55 CM / INCH 23.6x21.6

341 07 03
80x55 CM / INCH 31.5x21.6

341 07 05
100x55 CM / INCH 39.4x21.6

SPARE PART OF / RECAMBIO DE
1 OR 2 DRAWERS ADDITIONAL UNITS
MUEBLES AUXILIARES CON 1 O 2 CAJONES

UPPER DRAWER FOR WASHBASIN CABINET
CAJÓN SUPERIOR MUEBLE PARA LAVABO

(45 CM / INCH 17.7)

341 07 06
60x45 CM / INCH 23.6x17.7

341 07 08
80x45 CM / INCH 31.5x17.7

341 07 10
100x45 CM / INCH 39.4x17.7

(55 CM / INCH 21.6)

341 07 07
60x55 CM / INCH 23.6x21.6

341 07 09
80x55 CM / INCH 31.5x21.6

341 07 11
100x55 CM / INCH 39.4x21.6

SPARE PART OF / RECAMBIO DE
1 OR 2 DRAWERS CABINETS FOR WASHBASIN
MUEBLES PARA LAVABO CON 1 O 2 CAJONES

LOWER DRAWER
CAJÓN INFERIOR

(45 CM / INCH 17.7)

341 06 86
40x45 CM / INCH 15.7x17.7

341 06 88
50x45 CM / INCH 19.7x17.7

341 06 90
60x45 CM / INCH 23.6x17.7

341 06 92
80x45 CM / INCH 31.5x17.7

341 06 94
100x45 CM / INCH 39.4x17.7

(55 CM / INCH 21.6)

341 06 87
40x55 CM / INCH 15.7x21.6

341 06 89
50x55 CM / INCH 19.7x21.6

341 06 91
60x55 CM / INCH 23.6x21.6

341 06 93
80x55 CM / INCH 31.5x21.6

341 06 95
100x55 CM / INCH 39.4x21.6

SPARE PART OF / RECAMBIO DE
2 DRAWERS ADDITIONAL UNITS (50 CM TALL)
MUEBLES AUXILIARES CON 2 CAJONES (50CM DE ALTO)

Spare parts | Recambios

LOWER DRAWER FOR WASHBASIN CABINET CAJÓN INFERIOR MUEBLE PARA LAVABO

(45 CM / INCH 17.7)

3410718
60x45 CM / INCH 23.6x17.7

3410720
80x45 CM / INCH 31.5x17.7

3410722
100x45 CM / INCH 39.4x17.7

(55 CM / INCH 21.6)

3410719
60x55 CM / INCH 23.6x21.6

3410721
80x55 CM / INCH 31.5x21.6

3410723
100x55 CM / INCH 39.4x21.6

SPARE PART OF / RECAMBIO DE
2 DRAWERS CABINETS FOR WASHBASIN (50 CM TALL)
MUEBLES PARA LAVABO CON 2 CAJONES (50CM DE ALTO)

LOWER DRAWER CAJÓN INFERIOR

(45 CM / INCH 17.7)

3419063
40x45 CM / INCH 15.7x17.7

3419067
50x45 CM / INCH 19.7x17.7

3419072
60x45 CM / INCH 23.6x17.7

3419080
80x45 CM / INCH 31.5x17.7

3419088
100x45 CM / INCH 39.4x17.7

(55 CM / INCH 21.6)

3419065
40x55 CM / INCH 15.7x21.6

3419069
50x55 CM / INCH 19.7x21.6

3419076
60x55 CM / INCH 23.6x21.6

3419084
80x55 CM / INCH 31.5x21.6

3419092
100x55 CM / INCH 39.4x21.6

SPARE PART OF / RECAMBIO DE
2 DRAWERS ADDITIONAL UNITS (70 CM TALL)
MUEBLES AUXILIARES CON 2 CAJONES (70CM DE ALTO)

LOWER DRAWER FOR WASHBASIN CABINET CAJÓN INFERIOR MUEBLE PARA LAVABO

(45 CM / INCH 17.7)

3419073
60x45 CM / INCH 23.6x17.7

3419081
80x45 CM / INCH 31.5x17.7

3419089
100x45 CM / INCH 39.4x17.7

(55 CM / INCH 21.6)

3419076
60x55 CM / INCH 23.6x21.6

3419084
80x55 CM / INCH 31.5x21.6

3419092
100x55 CM / INCH 39.4x21.6

SPARE PART OF / RECAMBIO DE
2 DRAWERS CABINETS FOR WASHBASIN (70 CM TALL)
MUEBLES PARA LAVABO CON 2 CAJONES (70CM DE ALTO)

DRAWER RAIL SYSTEM JUEGO GUÍAS CAJÓN

3419095
30 CM / INCH 11.8

SPARE PART OF / RECAMBIO DE
CABINETS FOR WASHBASIN (45 CM DEPTH)
MUEBLES PARA LAVABO DE 45CM DE PROFUNDIDAD

3419096
40 CM / INCH 15.7

SPARE PART OF / RECAMBIO DE
ADDITIONAL UNITS (45 CM DEPTH)
MUEBLES AUXILIARES DE 45CM DE PROFUNDIDAD

CABINETS FOR WASHBASIN (55 CM DEPTH)
MUEBLES PARA LAVABO DE 55CM DE PROFUNDIDAD

3419097
50 CM / INCH 19.7

SPARE PART OF / RECAMBIO DE
ADDITIONAL UNITS (55 CM DEPTH)
MUEBLES AUXILIARES DE 55CM DE PROFUNDIDAD

UPPER FRONT PART FRONTAL SUPERIOR

(40CM / INCH 15.7)

74N 99 024 AAA
PVC

74N 99 024 BBB
MATTE / MATE

74N 99 024 CCC
GLOSSY / BRILLO

(50CM / INCH 19.7)

74N 99 025 AAA
PVC

74N 99 025 BBB
MATTE / MATE

74N 99 025 CCC
GLOSSY / BRILLO

(60CM / INCH 23.6)

74N 99 026 AAA
PVC

74N 99 026 BBB
MATTE / MATE

74N 99 026 CCC
GLOSSY / BRILLO

(80CM / INCH 31.5)

74N 99 027 AAA
PVC

74N 99 027 BBB
MATTE / MATE

74N 99 027 CCC
GLOSSY / BRILLO

(100CM / INCH 39.4)

74N 99 028 AAA
PVC

74N 99 028 BBB
MATTE / MATE

74N 99 028 CCC
GLOSSY / BRILLO

SPARE PART OF / RECAMBIO DE
1 OR 2 DRAWERS CABINETS
MUEBLES CON 1 O 2 CAJONES



Modular

Design by Àlex Armenter

LOWER FRONT PART CABINET 50 CM
FRONTAL INFERIOR MUEBLE DE 50CM

(40CM / INCH 15.7)

74N 99 014 AAA
PVC

74N 99 014 BBB
MATTE / MATE

74N 99 014 CCC
GLOSSY / BRILLO

(50CM / INCH 19.7)

74N 99 015 AAA
PVC

74N 99 015 BBB
MATTE / MATE

74N 99 015 CCC
GLOSSY / BRILLO

(60CM / INCH 23.6)

74N 99 016 AAA
PVC

74N 99 016 BBB
MATTE / MATE

74N 99 016 CCC
GLOSSY / BRILLO

(80CM / INCH 31.5)

74N 99 017 AAA
PVC

74N 99 017 BBB
MATTE / MATE

74N 99 017 CCC
GLOSSY / BRILLO

(100CM / INCH 39.4)

74N 99 018 AAA
PVC

74N 99 018 BBB
MATTE / MATE

74N 99 018 CCC
GLOSSY / BRILLO

SPARE PART OF / RECAMBIO DE
2 DRAWERS CABINETS (50 CM TALL)
MUEBLES CON 2 CAJONES (50CM DE ALTO)

LOWER FRONT PART CABINET 70 CM
FRONTAL INFERIOR MUEBLE DE 70CM

(40CM / INCH 15.7)

74N 99 004 AAA
PVC

74N 99 004 BBB
MATTE / MATE

74N 99 004 CCC
GLOSSY / BRILLO

(50CM / INCH 19.7)

74N 99 005 AAA
PVC

74N 99 005 BBB
MATTE / MATE

74N 99 005 CCC
GLOSSY / BRILLO

(60CM / INCH 23.6)

74N 99 006 AAA
PVC

74N 99 006 BBB
MATTE / MATE

74N 99 006 CCC
GLOSSY / BRILLO

(80CM / INCH 31.5)

74N 99 007 AAA
PVC

74N 99 007 BBB
MATTE / MATE

74N 99 007 CCC
GLOSSY / BRILLO

(100CM / INCH 39.4)

74N 99 008 AAA
PVC

74N 99 008 BBB
MATTE / MATE

74N 99 008 CCC
GLOSSY / BRILLO

SPARE PART OF / RECAMBIO DE
2 DRAWERS CABINETS (70 CM TALL)
MUEBLES CON 2 CAJONES (70CM DE ALTO)

DOOR CABINET 50 CM
PUERTA MUEBLE DE 50CM

(30/60CM / INCH 11.8/23.6)

74N 99 011 AAA
PVC

74N 99 011 BBB
MATTE / MATE

74N 99 011 CCC
GLOSSY / BRILLO

(40/80CM / INCH 15.7/31.5)

74N 99 012 AAA
PVC

74N 99 012 BBB
MATTE / MATE

74N 99 012 CCC
GLOSSY / BRILLO

(50/100CM / INCH 19.7/39.4)

74N 99 013 AAA
PVC

74N 99 013 BBB
MATTE / MATE

74N 99 013 CCC
GLOSSY / BRILLO

SPARE PART OF / RECAMBIO DE
1 OR 2 DOORS CABINETS (50 CM TALL)
MUEBLES CON 1 O 2 PUERTAS (50CM DE ALTO)

DOOR CABINET 70 CM
PUERTA MUEBLE DE 70CM

(30/60CM / INCH 11.8/23.6)

74N 99 001 AAA
PVC

74N 99 001 BBB
MATTE / MATE

74N 99 001 CCC
GLOSSY / BRILLO

(40/80CM / INCH 15.7/31.5)

74N 99 002 AAA
PVC

74N 99 002 BBB
MATTE / MATE

74N 99 002 CCC
GLOSSY / BRILLO

(50/100CM / INCH 19.7/39.4)

74N 99 003 AAA
PVC

74N 99 003 BBB
MATTE / MATE

74N 99 003 CCC
GLOSSY / BRILLO

SPARE PART OF / RECAMBIO DE
1 OR 2 DOORS CABINETS (70 CM TALL)
MUEBLES CON 1 O 2 PUERTAS (70CM DE ALTO)

ALUMINIUM SHELF FOR WASHBASIN CABINET
ESTANTE ALUMINIO MUEBLE PARA LAVABO

341 90 57
60 CM / INCH 23.6

341 90 58
80 CM / INCH 31.5

341 90 59
100 CM / INCH 39.4

SPARE PART OF / RECAMBIO DE
2 DOORS CABINETS FOR WASHBASIN
MUEBLES PARA LAVABO CON 2 PUERTAS

Spare parts | Recambios

WOOD SHELF FOR CABINET
ESTANTE MADERA PARA MUEBLE

(45CM / INCH 17.7)

34190 45
30x45 CM / INCH 11.8x17.7

34190 46
40x45 CM / INCH 15.7x17.7

34190 47
50x45 CM / INCH 19.7x17.7

SPARE PART OF / RECAMBIO DE
1 DOOR ADDITIONAL UNITS
MUEBLES AUXILIARES CON 1 PUERTA

34190 48
60x45 CM / INCH 23.6x17.7

34190 49
80x45 CM / INCH 31.5x17.7

34190 50
100x45 CM / INCH 39.4x17.7

SPARE PART OF / RECAMBIO DE
2 DOORS ADDITIONAL UNITS
MUEBLES AUXILIARES CON 2 PUERTAS

(55CM / INCH 21.7)

34190 51
30x55 CM / INCH 11.8x21.7

34190 52
40x55 CM / INCH 15.7x21.7

34190 53
50x55 CM / INCH 19.7x21.7

SPARE PART OF / RECAMBIO DE
1 DOOR ADDITIONAL UNITS
MUEBLES AUXILIARES CON 1 PUERTA

34190 54
60x55 CM / INCH 23.6x21.7

34190 55
80x55 CM / INCH 31.5x21.7

34190 56
100x55 CM / INCH 39.4x21.7

SPARE PART OF / RECAMBIO DE
2 DOORS ADDITIONAL UNITS
MUEBLES AUXILIARES CON 2 PUERTAS

CABINET HINGE
BISAGRA ARMARIO

34191 05

SPARE PART OF / RECAMBIO DE
1 OR 2 DOORS CABINETS & WALL CABINETS
ARMARIOS, MUEBLES CON 1 O 2 PUERTAS

CABINET WALL MOUNTING SET
ACCESORIO SUJECIÓN ARMARIO

34104 41

SPARE PART OF / RECAMBIO DE
CABINETS
ARMARIOS

CABINET SHELF
ESTANTE ALUMINIO ARMARIO COLUMNA

34190 77

SPARE PART OF / RECAMBIO DE
CABINETS
ARMARIOS

CABINET DOOR
PUERTA ARMARIO

744 000 AAA 002 83 99
PVC

744 000 BBB 002 83 99
MATTE / MATE

744 000 CCC 002 83 99
GLOSSY / BRILLO

SPARE PART OF / RECAMBIO DE
CABINETS
ARMARIOS

CABINET HINGE
BISAGRA MUEBLE

34191 08

SPARE PART OF / RECAMBIO DE
MEDICINE CABINETS
ARMARIOS ESPEJO

MIRROR DOOR
PUERTA ESPEJO

(RIGHT / DERECHA)

34190 36
40 CM / INCH 15.7

34190 37
50 CM / INCH 19.7

34190 38
60 CM / INCH 23.6

SPARE PART OF / RECAMBIO DE
RIGHT HANDSIDE MEDICINE CABINETS
ARMARIOS ESPEJO DERECHA

(LEFT / IZQUIERDA)

34194 11
40 CM / INCH 15.7

34194 12
50 CM / INCH 19.7

34194 13
60 CM / INCH 23.6

SPARE PART OF / RECAMBIO DE
LEFT HANDSIDE MEDICINE CABINETS
ARMARIOS ESPEJO IZQUIERDA

MIRROR DOOR FOR LIGHT
PUERTA ESPEJO PARA LUZ

(RIGHT / DERECHA)

34190 39
40 CM / INCH 15.7

34190 40
50 CM / INCH 19.7

34190 41
60 CM / INCH 23.6

SPARE PART OF / RECAMBIO DE
RIGHT HANDSIDE MEDICINE CABINETS WITH LIGHTING
ARMARIOS ESPEJO DERECHA CON LUZ

(LEFT / IZQUIERDA)

34190 42
40 CM / INCH 15.7

34190 43
50 CM / INCH 19.7

34190 44
60 CM / INCH 23.6

SPARE PART OF / RECAMBIO DE
LEFT HANDSIDE MEDICINE CABINETS WITH LIGHTING
ARMARIOS ESPEJO IZQUIERDA CON LUZ

GLASS FLAT SHELF
ESTANTE CRISTAL

34190 33
40 CM / INCH 15.7

34190 34
50 CM / INCH 19.7

34190 35
60 CM / INCH 23.6

SPARE PART OF / RECAMBIO DE
MEDICINE CABINETS
ARMARIOS ESPEJO

FLUORESCENT TUBE
TUBO FLUORESCENTE

34190 27
40-50 CM / INCH 15.7-19.7

34190 28
60 CM / INCH 23.6

SPARE PART OF / RECAMBIO DE
MEDICINE CABINETS WITH LIGHTING
ARMARIOS ESPEJO CON LUZ



Modular

Design by Àlex Armenter

DIFFUSER
DIFUSOR

34190 29
40 CM / 15.7 INCH

34190 30
50 CM / 19.7 INCH

34190 31
60 CM / 23.6 INCH

SPARE PART OF / RECAMBIO DE
MEDICINE CABINETS WITH LIGHTING
ARMARIOS ESPEJO CON LUZ

SOCKET
ENCHUFE

34190 32

SPARE PART OF / RECAMBIO DE
MEDICINE CABINETS WITH LIGHTING&SOCKET
ARMARIOS ESPEJO CON LUZ Y ENCHUFE



The Grid

Design by **Ricard Ferrer**





768121003
WASHBASIN WITH WATER CONTAINER 60 CM
LAVABO CON CONTENEDOR DE AGUA 60 CM

768001004194
1 DRAWER CABINET WITH LED, BLUETOOTH SPEAKERS & POWER SOCKET 60 CM
MUEBLE 1 CAJÓN CON LED, ALTAVOCES BLUETOOTH Y ENCHUFE 60 CM

768001011065194
LOWER UNIT WITH FIXED SHELF 60 CM
MÓDULO INFERIOR CON ESTANTE FIJO 60 CM

Parallel lines which frame objects
specifically designed for an
architecturally engineered bathroom.

Líneas paralelas que enmarcan
objetos dedicados a un baño concebido
desde la óptica arquitectónica.





2686563
BASKET 35 CM
CONTAINER 35 CM

2686565
TOWEL RACK WITH SHELF 55 CM
TOALLERO CON REPISA 55 CM





2680159
PAPER HOLDER WITH COVER
PORTAPEPEL CON TAPA

2680100
FREE-STANDING OR WALL
MOUNTABLE TOILET BRUSH
ESCOBILLERO SUELO/PARED









768000518001265
PORTABLE TOILET BRUSH + PAPER HOLDER + WASTE BIN
PORTÁTIL ESCOBILLERO + PORTAPAPEL + PAPELERA

7680190
LED WALL LAMP 30 CM
APLIQUE LED 30 CM

768000505064
MEDICINE CABINET 35 CM
ARMARIO ESPEJO 35 CM

768001014001064
AUXILIARY UNIT WITH SLIDING SHELF 60 CM
MÓDULO AUXILIAR CON ESTANTE DESLIZANTE 60 CM





768000905195
MEDICINE CABINET 55 CM
ARMARIO ESPEJO 55 CM

2683665
TOWEL RACK WITH SHELF 55 CM
TOALLERO CON REPISA 55 CM



768121403
WASHBASIN WITH WATER CONTAINER 80 CM
LAVABO CON CONTENEDOR DE AGUA 80 CM

768001404195
1 DRAWER CABINET WITH LED, BLUETOOTH SPEAKERS & POWER SOCKET 80 CM
MUEBLE 1 CAJÓN CON LED, ALTAVOCES BLUETOOTH Y ENCHUFE 80 CM

768001412036195
LOWER UNIT WITH SLIDING SHELF 80 CM
MÓDULO INFERIOR CON ESTANTE DESLIZANTE 80 CM







The Grid

Design by Ricard Ferrer



Plant resins: this is the first ecologically sustainable solid surface derived from plant resins mixed with highly pure natural minerals. Some 30% of the resin component, formerly of fossil origin, has been replaced with polyesters of plant origin from certified growers.

Resinas de origen vegetal: es el primer solid surface eco sostenible que deriva de materias primas resinosas de origen vegetal mezcladas con minerales inertes y naturales de extrema pureza. El 30% de la resina, anteriormente de origen fósil, ha sido substituida por poliésteres de origen vegetal procedentes de cultivos certificados.

**CRISTALPLANT®
BIOBASED**

Matching items. The washbasin may be installed alone or attached to a one-drawer unit. Another lower module with a shelf or removable dish may be added to the set.

Elementos combinables. Se puede instalar el lavabo sólo o unido a un mueble de un cajón. Al conjunto se le puede añadir otro módulo inferior con estante o bandeja extraíble.

Non-GMO: VOC (Volatile organic compounds) and BIO-BASED points awarded for the eco-sustainability certificate "Leadership in Energy and Environmental Design". This material has been certified as containing resins derived from vegetable starches and non-GMO corn. While the minimum requirement is 5%, these resins reach 12% in our product. 100% Recyclable: can be replaced and used at the end of life as inert.

Sin OGM: es un material idóneo para obtener puntuación VOC (Compuestos Orgánicos Volátiles) y BIO-BASED para el certificado de eco-sostenibilidad "Leadership in Energy and Environmental Design". El material obtuvo el certificado que confirma que las resinas derivan de almidones vegetales y maíz sin OGM (organismos genéticamente modificados); en el material, dichas resinas superan incluso el 12%, cuando el requisito mínimo es normalmente del 5%. Reciclable 100%: puede ser reemplazado y utilizado al final de la vida como inerte.



Practical container to store water for various purposes, such as shaving.

Práctico contenedor para retener el agua para ciertos usos como el afeitado.



Less CO₂: 30% lighter which not only allows for easier manipulation and installation but produces less CO₂ than other similar products.

Menos CO₂: composición muy ligera, ha reducido su peso específico en un 30%, produciendo, por tanto, menos CO₂ con respecto a productos similares disponibles actualmente en el mercado, además de facilitar su manipulación e instalación.



Space optimisation thanks to the moveable smoked glass dividers.

Optimización del espacio gracias al sistema de separadores móviles en vidrio fumé.

Furniture | Muebles

Eco friendly: furniture made in Spain with certified wood board (PEFC/FSC) following the chain of custody in forestry. Lacquered finishing and high quality laminate. Colours unalterable over time.

Producto ambientalmente responsable: muebles fabricados en España con tableros de madera certificada (PEFC/FSC) conforme la cadena de custodia de productos forestales. Acabados lacados y chapados de alta gama. Los tonos se mantienen inalterables a lo largo del tiempo.



Push open & soft close: Self & soft close with new rail system which can be completely removed. The long lasting durability of drawers is assured by quality control tests (up to 20,000 times).

Push open & soft close: Apertura y cierre amortiguado con guías de extracción total ocultas. La durabilidad de los cajones está asegurada ya que han superado con éxito hasta 20.000 ciclos en los test de control de calidad.



Modules with fixed shelf or sliding drawer.

Módulos con estante fijo o cajón deslizante.



The Grid range has successfully passed the high demanding tests of long last durability and resistance to extreme uses (static charge or impact testing) to assure long last durability of the product.

Toda la gama **The Grid** ha superado con éxito exigentes tests de durabilidad y resistencia a usos extremos (cargas estáticas o test de impacto), para asegurar una larga vida al producto.



Possibility to incorporate LED lighting (which lights up automatically on opening the drawer), sockets and 2x15 W stereo speakers with Bluetooth connection.

Posibilidad de incorporar luz LED que se ilumina automáticamente al abrir el cajón, enchufes y altavoces estéreo con conexión Bluetooth de 2x15W de potencia.



4.8 W LED wall lamps with a 4000 k neutral white light (not cold) and transformer hidden in the supporting bracket.

Apliques LED con una luz neutra (no fría) de 4000k y de 4,8W de potencia y transformador oculto en el brazo del soporte.



Mirror cabinets with fumed glass shelves.

Armarios espejo con estantes en cristal fumé.



The Grid

Design by Ricard Ferrer



COMBINATIONS / COMBINACIONES



FINISHES / ACABADOS

STRUCTURE FINISHES ACABADOS ESTRUCTURA

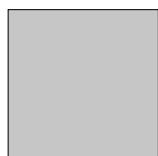

01
CHROME
CROMO



65
MATE WHITE
BLANCO MATE



36
MATE BLACK
NEGRO MATE

SHELF/FURNITURE FINISHES ACABADOS ESTANTES/MUEBLES

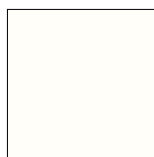

102
MATE WHITE
BLANCO MATE

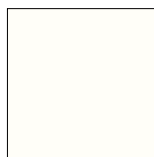

064
GLOSSY WHITE
BLANCO BRILLO

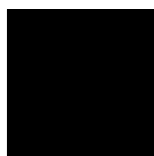

108
MATE BLACK
NEGRO MATE



034
GLOSSY BLACK
NEGRO BRILLO



194
CLEAR OAK
ROBLE CLARO



195
DARK OAK
ROBLE OSCURO



WASHBASIN WITH WATER CONTAINER
LAVABO CON CONTENEDOR DE AGUA

768 12 10 03
60 CM

768 12 14 03
80 CM

768 12 18 03
100 CM

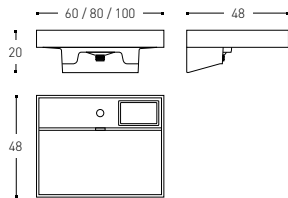

INCH 23.6/31.5/39.4x18.9x7.9



WASHBASIN WITH WATER CONTAINER WITHOUT TAP HOLE
LAVABO CON CONTENEDOR DE AGUA SIN AGUJERO

768 12 10 02
60 CM

768 12 14 02
80 CM

768 12 18 02
100 CM

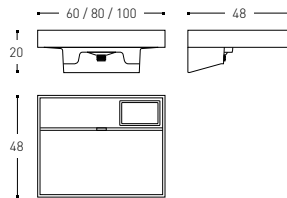

INCH 23.6/31.5/39.4x18.9x7.9



TRAP
SIFÓN

341 05 90

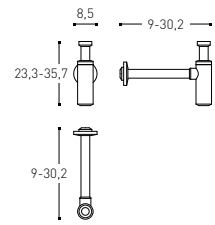

INCH 3.3x3.5-11.9x9.2-14



1 DRAWER CABINET
MUEBLE 1 CAJÓN
60 CM

- 768 00 10 01 102**
- 768 00 10 01 064**
- 768 00 10 01 108**
- 768 00 10 01 034**
- 768 00 10 01 194**
- 768 00 10 01 195**

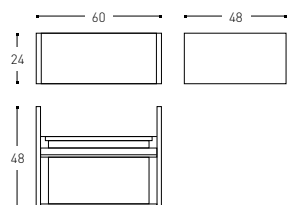

INCH 23.6x18.9x9.5



1 DRAWER CABINET
MUEBLE 1 CAJÓN
80 CM

- 768 00 14 01 102**
- 768 00 14 01 064**
- 768 00 14 01 108**
- 768 00 14 01 034**
- 768 00 14 01 194**
- 768 00 14 01 195**

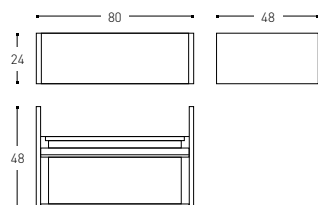

INCH 31.5x18.9x9.5



1 DRAWER CABINET
MUEBLE 1 CAJÓN
100 CM

- 768 00 18 01 102**
- 768 00 18 01 064**
- 768 00 18 01 108**
- 768 00 18 01 034**
- 768 00 18 01 194**
- 768 00 18 01 195**

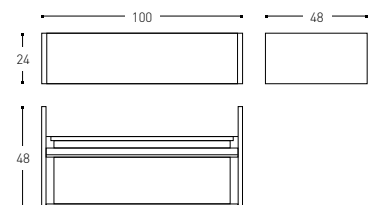

INCH 39.4x18.9x9.5



The Grid

Design by Ricard Ferrer



1 DRAWER CABINET WITH LED AND POWER SOCKET
MUEBLE 1 CAJÓN CON LED Y ENCHUFE
60 CM

- 768 00 10 02 102**
- 768 00 10 02 064**
- 768 00 10 02 108**
- 768 00 10 02 034**
- 768 00 10 02 194**
- 768 00 10 02 195**

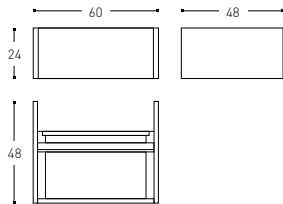

INCH 23.6x18.9x9.5



1 DRAWER CABINET WITH LED AND POWER SOCKET
MUEBLE 1 CAJÓN CON LED Y ENCHUFE
80 CM

- 768 00 14 02 102**
- 768 00 14 02 064**
- 768 00 14 02 108**
- 768 00 14 02 034**
- 768 00 14 02 194**
- 768 00 14 02 195**

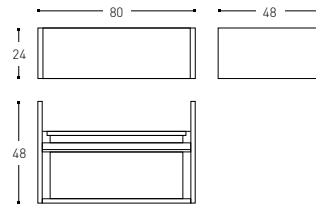

INCH 31.5x18.9x9.5



1 DRAWER CABINET WITH LED AND POWER SOCKET
MUEBLE 1 CAJÓN CON LED Y ENCHUFE
100 CM

- 768 00 18 02 102**
- 768 00 18 02 064**
- 768 00 18 02 108**
- 768 00 18 02 034**
- 768 00 18 02 194**
- 768 00 18 02 195**

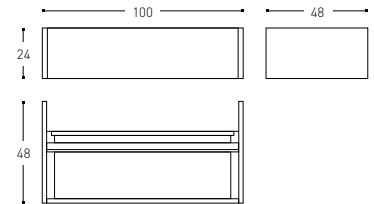

INCH 39.4x18.9x9.5



1 DRAWER CABINET WITH LED, BLUETOOTH
SPEAKERS & POWER SOCKET
MUEBLE 1 CAJÓN CON LED, ALTAVOCES
BLUETOOTH Y ENCHUFE
60 CM

- 768 00 10 04 102**
- 768 00 10 04 064**
- 768 00 10 04 108**
- 768 00 10 04 034**
- 768 00 10 04 194**
- 768 00 10 04 195**

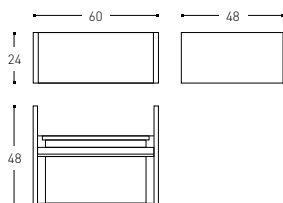

INCH 23.6x18.9x9.5



1 DRAWER CABINET WITH LED, BLUETOOTH
SPEAKERS & POWER SOCKET
MUEBLE 1 CAJÓN CON LED, ALTAVOCES
BLUETOOTH Y ENCHUFE
80 CM

- 768 00 14 04 102**
- 768 00 14 04 064**
- 768 00 14 04 108**
- 768 00 14 04 034**
- 768 00 14 04 194**
- 768 00 14 04 195**

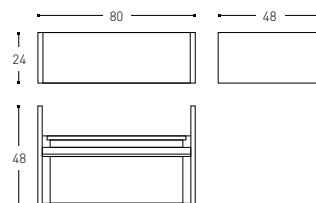

INCH 31.5x18.9x9.5



1 DRAWER CABINET WITH LED, BLUETOOTH
SPEAKERS & POWER SOCKET
MUEBLE 1 CAJÓN CON LED, ALTAVOCES
BLUETOOTH Y ENCHUFE
100 CM

- 768 00 18 04 102**
- 768 00 18 04 064**
- 768 00 18 04 108**
- 768 00 18 04 034**
- 768 00 18 04 194**
- 768 00 18 04 195**

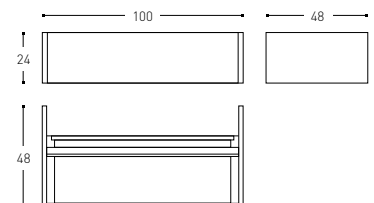

INCH 39.4x18.9x9.5



LOWER UNIT WITH FIXED SHELF
MÓDULO INFERIOR CON ESTANTE FIJO
60 CM

- □ 768 00 10 110 01 102
- ■ 768 00 10 110 01 108
- ■ 768 00 10 110 01 194
- ■ 768 00 10 110 01 195
- □ 768 00 10 110 65 102
- ■ 768 00 10 110 65 108
- ■ 768 00 10 110 65 194
- ■ 768 00 10 110 65 195
- □ 768 00 10 110 36 102
- ■ 768 00 10 110 36 108
- ■ 768 00 10 110 36 194
- ■ 768 00 10 110 36 195

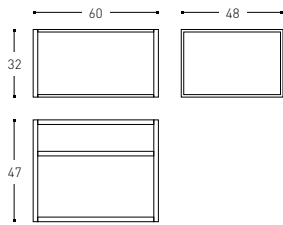

INCH 23.6/31.5/39.4x18.9x12.6



LOWER UNIT WITH FIXED SHELF
MÓDULO INFERIOR CON ESTANTE FIJO
80 CM

- □ 768 00 14 110 01 102
- ■ 768 00 14 110 01 108
- ■ 768 00 14 110 01 194
- ■ 768 00 14 110 01 195
- □ 768 00 14 110 65 102
- ■ 768 00 14 110 65 108
- ■ 768 00 14 110 65 194
- ■ 768 00 14 110 65 195
- □ 768 00 14 110 36 102
- ■ 768 00 14 110 36 108
- ■ 768 00 14 110 36 194
- ■ 768 00 14 110 36 195

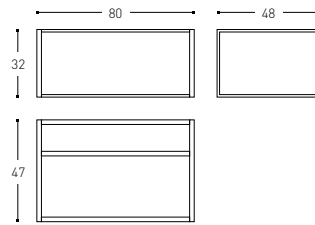

INCH 31.5x18.9x12.6

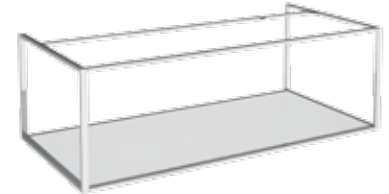

LOWER UNIT WITH FIXED SHELF
MÓDULO INFERIOR CON ESTANTE FIJO
100 CM

- □ 768 00 18 110 01 102
- ■ 768 00 18 110 01 108
- ■ 768 00 18 110 01 194
- ■ 768 00 18 110 01 195
- □ 768 00 18 110 65 102
- ■ 768 00 18 110 65 108
- ■ 768 00 18 110 65 194
- ■ 768 00 18 110 65 195
- □ 768 00 18 110 36 102
- ■ 768 00 18 110 36 108
- ■ 768 00 18 110 36 194
- ■ 768 00 18 110 36 195

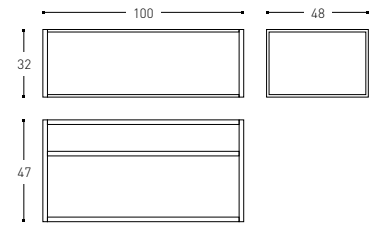

INCH 31.5x18.9x12.6



The Grid

Design by Ricard Ferrer



LOWER UNIT WITH SLIDING SHELF
MÓDULO INFERIOR CON ESTANTE DESLIZANTE
60 CM

- □ 768 00 10 120 01 102
- □ 768 00 10 120 01 064
- ■ 768 00 10 120 01 108
- ■ 768 00 10 120 01 034
- ■ 768 00 10 120 01 194
- ■ 768 00 10 120 01 195
- □ 768 00 10 120 65 102
- □ 768 00 10 120 65 064
- ■ 768 00 10 120 65 108
- ■ 768 00 10 120 65 034
- ■ 768 00 10 120 65 194
- ■ 768 00 10 120 65 195
- □ 768 00 10 120 36 102
- □ 768 00 10 120 36 064
- ■ 768 00 10 120 36 108
- ■ 768 00 10 120 36 034
- ■ 768 00 10 120 36 194
- ■ 768 00 10 120 36 195

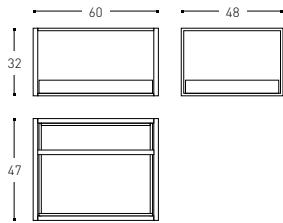

INCH 23.6x18.9x12.6



LOWER UNIT WITH SLIDING SHELF
MÓDULO INFERIOR CON ESTANTE DESLIZANTE
80 CM

- □ 768 00 14 120 01 102
- □ 768 00 14 120 01 064
- ■ 768 00 14 120 01 108
- ■ 768 00 14 120 01 034
- ■ 768 00 14 120 01 194
- ■ 768 00 14 120 01 195
- □ 768 00 14 120 65 102
- □ 768 00 14 120 65 064
- ■ 768 00 14 120 65 108
- ■ 768 00 14 120 65 034
- ■ 768 00 14 120 65 194
- ■ 768 00 14 120 65 195
- □ 768 00 14 120 36 102
- □ 768 00 14 120 36 064
- ■ 768 00 14 120 36 108
- ■ 768 00 14 120 36 034
- ■ 768 00 14 120 36 194
- ■ 768 00 14 120 36 195

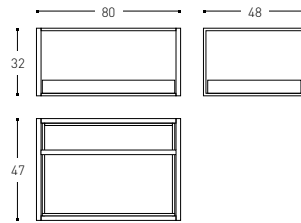

INCH 31.5x18.9x12.6

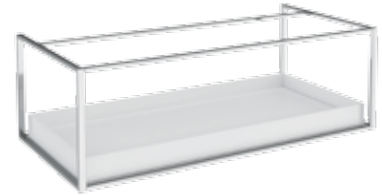

LOWER UNIT WITH SLIDING SHELF
MÓDULO INFERIOR CON ESTANTE DESLIZANTE
100 CM

- □ 768 00 18 120 01 102
- □ 768 00 18 120 01 064
- ■ 768 00 18 120 01 108
- ■ 768 00 18 120 01 034
- ■ 768 00 18 120 01 194
- ■ 768 00 18 120 01 195
- □ 768 00 18 120 65 102
- □ 768 00 18 120 65 064
- ■ 768 00 18 120 65 108
- ■ 768 00 18 120 65 034
- ■ 768 00 18 120 65 194
- ■ 768 00 18 120 65 195
- □ 768 00 18 120 36 102
- □ 768 00 18 120 36 064
- ■ 768 00 18 120 36 108
- ■ 768 00 18 120 36 034
- ■ 768 00 18 120 36 194
- ■ 768 00 18 120 36 195

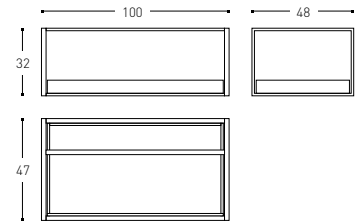

INCH 39.4x18.9x12.6



AUXILIARY UNIT WITH FIXED SHELF
MÓDULO AUXILIAR CON ESTANTE FIJO
60 CM

- □ 768 00 10 130 01 102
- ■ 768 00 10 130 01 108
- ■ 768 00 10 130 01 194
- ■ 768 00 10 130 01 195
- □ 768 00 10 130 65 102
- ■ 768 00 10 130 65 108
- ■ 768 00 10 130 65 194
- ■ 768 00 10 130 65 195
- □ 768 00 10 130 36 102
- ■ 768 00 10 130 36 108
- ■ 768 00 10 130 36 194
- ■ 768 00 10 130 36 195

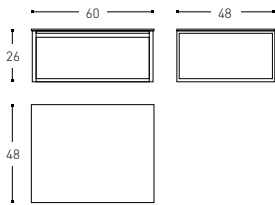

INCH 23.6x18.9x12.6



AUXILIARY UNIT WITH SLIDING SHELF
MÓDULO AUXILIAR CON ESTANTE DESLIZANTE
60 CM

- □ 768 00 10 140 01 102
- □ 768 00 10 140 01 064
- ■ 768 00 10 140 01 108
- ■ 768 00 10 140 01 034
- ■ 768 00 10 140 01 194
- ■ 768 00 10 140 01 195
- □ 768 00 10 140 65 102
- □ 768 00 10 140 65 064
- ■ 768 00 10 140 65 108
- ■ 768 00 10 140 65 034
- ■ 768 00 10 140 65 194
- ■ 768 00 10 140 65 195
- □ 768 00 10 140 36 102
- □ 768 00 10 140 36 064
- ■ 768 00 10 140 36 108
- ■ 768 00 10 140 36 034
- ■ 768 00 10 140 36 194
- ■ 768 00 10 140 36 195

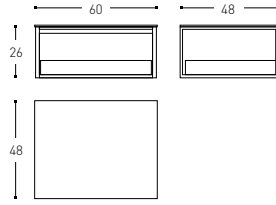

INCH 23.6x18.9x9.8



FREE-STANDING AUXILIARY SHELF
MUEBLE AUXILIAR
80 CM

- ■ 768 00 14 150 01 194
- ■ 768 00 14 150 01 195
- □ 768 00 14 150 01 265
- ■ 768 00 14 150 65 194
- ■ 768 00 14 150 65 195
- □ 768 00 14 150 65 265
- ■ 768 00 14 150 36 194
- ■ 768 00 14 150 36 195
- □ 768 00 14 150 36 265

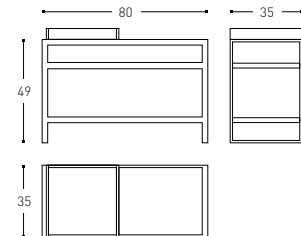

INCH 31.5x13.8x19.3



The Grid

Design by Ricard Ferrer



○□△
STOOL
TABURETE

- 768 00 06 160 01 194
- 768 00 06 160 01 195
- 768 00 06 160 01 265
- 768 00 06 160 65 194
- 768 00 06 160 65 195
- 768 00 06 160 65 265
- 768 00 06 160 36 194
- 768 00 06 160 36 195
- 768 00 06 160 36 265

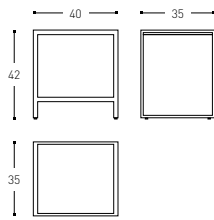

INCH 15.8x13.8x16.5



■
SHOWER SEAT
BANQUETA DE DUCHA

768 121120

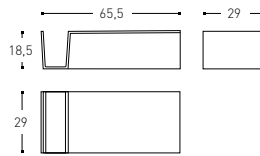

INCH 25.8x11.4x7.3



●
LED WALL LAMP
APLIQUE LED

- 768 0190
30 CM
- 768 6590
30 CM
- 768 3690
30 CM
- 768 0191
45 CM
- 768 6591
45 CM
- 768 3691
45 CM

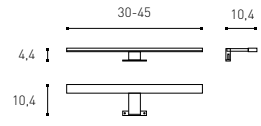

INCH 11.8-17.7x4.14x1.7



◆ ◻ ■
MEDICINE CABINET
ARMARIO ESPEJO
 35 CM

- ◻ **768 00 05 05 102**
- ◻ **768 00 05 05 064**
- **768 00 05 05 108**
- **768 00 05 05 034**
- **768 00 05 05 194**
- **768 00 05 05 195**

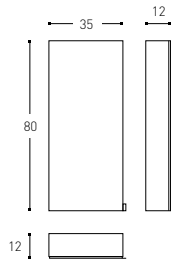

INCH 13.8x4.7x31.5



◆ ◻ ■
MEDICINE CABINET
ARMARIO ESPEJO
 55 CM

- ◻ **768 00 09 05 102**
- ◻ **768 00 09 05 064**
- **768 00 09 05 108**
- **768 00 09 05 034**
- **768 00 09 05 194**
- **768 00 09 05 195**

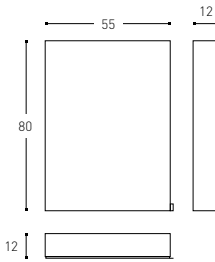

INCH 21.7x4.7x31.5



The Grid

Design by Ricard Ferrer

DRYWALL ANCHOR UX-R Ø6X35MM
TACO PLADUR UX-R Ø6X35MM

3410636

SPARE PART OF / RECAMBIO DE

WASHBASIN/MIRROR MOUNTING SET
ACCESORIO SUJECION LAVABO

3307500

SPARE PART OF / RECAMBIO DE

7628121003, 7680121403, 768121803, 768121120

PREVEX TRAP
SIFÓN PREVEX

3419456

SPARE PART OF / RECAMBIO DE

768001001AAA, 768001002AAA, 768001004AAA, 768001401AAA, 768001402AAA, 768001404AAA, 768001801AAA, 768001802AAA, 768001804AAA

CLEANING SET
KIT DE LIMPIEZA

3410295

SPARE PART OF / RECAMBIO DE

7628121003, 7680121403, 768121803, 768121120

REPAIRING KIT
KIT REPARACIÓN

3410296

SPARE PART OF / RECAMBIO DE

7628121003, 7680121403, 768121803, 768121120

CABINET WITH WASHBASIN MOUNTING SET
ACCESORIO SUJECIÓN MUEBLE CON LAVABO

3410683

SPARE PART OF / RECAMBIO DE

768001001BBB, 768001002BBB, 768001004BBB, 768001401BBB, 768001402BBB, 768001404BBB, 768001801BBB, 768001802BBB, 7680018304BBB

LOWER UNIT MOUNTING SET TO CABINET
ACCESORIO SUJECIÓN MÓDULO A MUEBLE

3419455

SPARE PART OF / RECAMBIO DE

768001011001AAA, 768001011036AAA, 768001011065AAA, 768001012001AAA, 768001012036AAA, 768001012065AAA, 768001411001AAA, 768001411036AAA, 768001411065AAA, 768001412001AAA, 768001412036AAA, 768001412065AAA, 768001811001AAA, 768001811036AAA, 768001811065AAA, 768001812001AAA, 768001812036AAA, 768001812065AAA,

WALL MOUNTING SET FOR AUXILIARY UNIT
ACCESORIO FIJACIÓN A PARED MÓDULO AUXILIAR

3419453

BLACK / NEGRO

SPARE PART OF / RECAMBIO DE

768000713036AAA, 768000714036AAA, 768001013036AAA, 768001014036AAA

3419454

CHROME / CROMO

SPARE PART OF / RECAMBIO DE

768000713001AAA, 768000713065AAA, 768000714001AAA, 768000714065AAA, 768001013001AAA, 768001013065AAA, 768001014001AAA, 768001014065AAA

DRAWER
CAJÓN

3419440

SPARE PART OF / RECAMBIO DE

768001001034, 768001001064, 768001001102, 768001001108, 768001001194, 768001001195, 768001002034, 768001002064, 768001002102, 768001002108, 768001002194, 768001002195, 768001004034, 768001004064, 768001004102, 768001004108, 768001004194, 768001004195

3419441

SPARE PART OF / RECAMBIO DE

768001401034, 768001401064, 768001401102, 768001401108, 768001401194, 768001401195, 768001402034, 768001402064, 768001402102, 768001402108, 768001402194, 768001402195, 768001404034, 768001404064, 768001404102, 768001404108, 768001404194, 768001404195

3419442

SPARE PART OF / RECAMBIO DE

768001801034, 768001801064, 768001801102, 768001801108, 768001801194, 768001801195, 768001802034, 768001802064, 768001802102, 768001802108, 768001802194, 768001802195, 768001804034, 768001804064, 768001804102, 768001804108, 768001804194, 768001804195

GUIDES SYNCHRONIZER
SINCRONIZADOR GUIAS

3419443

SPARE PART OF / RECAMBIO DE

768001401034, 768001401064, 768001401102, 768001401108, 768001401194, 768001401195, 768001402034, 768001402064, 768001402102, 768001402108, 768001402194, 768001402195, 768001404034, 768001404064, 768001404102, 768001404108, 768001404194, 768001404195, 768001801034, 768001801064, 768001801102, 768001801108, 768001801194, 768001801195, 768001802034, 768001802064, 768001802102, 768001802108, 768001802194, 768001802195, 768001804034, 768001804064, 768001804102, 768001804108, 768001804194, 768001804195,

RAIL SYSTEM
JUEGO GUIAS

3419444

SPARE PART OF / RECAMBIO DE

768001001AAA, 768001002AAA, 768001004AAA, 768001401AAA, 768001402AAA, 768001403AAA, 768001801AAA, 768001802AAA, 768001804AAA

FRONT PART 60CM / INCH 23.6
FRONTAL 60CM / INCH 23.6

3419422

LACQUERED MATTE WHITE / LACADO BLANCO MATE

SPARE PART OF / RECAMBIO DE

768001001102, 768001002102, 768001004102

3419423

LACQUERED MATTE BLACK / LACADO NEGRO MATE

SPARE PART OF / RECAMBIO DE

768001001064, 768001002064, 768001004064

3419424

GLOSSY WHITE LACQUERED / LACADO BLANCO BRILLO

SPARE PART OF / RECAMBIO DE

768001001108, 768001002108, 768001004108

3419425

GLOSSY BLACK LACQUERED / LACADO NEGRO BRILLO

SPARE PART OF / RECAMBIO DE

768001001034, 768001002034, 768001004034

3419426

CLEAR OAK / ROBLE CLARO

SPARE PART OF / RECAMBIO DE

768001001194, 768001002194, 768001004194

3419427

DARK OAK / ROBLE OSCURO

SPARE PART OF / RECAMBIO DE

768001001195, 768001002195, 768001004195

Spare parts | Recambios

FRONT PART FRONTAL

3419428

LACQUERED MATTE WHITE / LACADO BLANCO MATE

SPARE PART OF / RECAMBIO DE
768001401102, 768001402102, 768001404102

3419429

LACQUERED MATTE BLACK / LACADO NEGRO MATE

SPARE PART OF / RECAMBIO DE
768001401064, 768001402064, 768001404064

3419430

GLOSSY WHITE LACQUERED / LACADO BLANCO BRILLO

SPARE PART OF / RECAMBIO DE
768001401108, 768001402108, 768001404108

3419431

GLOSSY BLACK LACQUERED / LACADO NEGRO BRILLO

SPARE PART OF / RECAMBIO DE
768001401034, 768001402034, 768001404034

3419432

CLEAR OAK / ROBLE CLARO

SPARE PART OF / RECAMBIO DE
768001401194, 768001402194, 768001404194

3419433

DARK OAK / ROBLE OSCURO

SPARE PART OF / RECAMBIO DE
768001401195, 768001402195, 768001404195

FRONT PART 100CM / INCH 39.4 FRONTAL 100CM / INCH 39.4

3419434

LACQUERED MATTE WHITE / LACADO BLANCO MATE

SPARE PART OF / RECAMBIO DE
768001801102, 768001802102, 768001804102

3419435

LACQUERED MATTE BLACK / LACADO NEGRO MATE

SPARE PART OF / RECAMBIO DE
768001801064, 768001802064, 768001804064

3419436

GLOSSY WHITE LACQUERED / LACADO BLANCO BRILLO

SPARE PART OF / RECAMBIO DE
768001801108, 768001802108, 768001804108

3419437

GLOSSY BLACK LACQUERED / LACADO NEGRO BRILLO

SPARE PART OF / RECAMBIO DE
768001801034, 768001802034, 768001804034

3419438

CLEAR OAK / ROBLE CLARO

SPARE PART OF / RECAMBIO DE
768001801194, 768001802194, 768001804194

3419439

DARK OAK / ROBLE OSCURO

SPARE PART OF / RECAMBIO DE
768001801195, 768001802195, 768001804195

DRAWER DIVIDERS SEPARADOR CAJÓN

3419451

SPARE PART OF / RECAMBIO DE
768001001AAA, 768001002AAA, 768001004AAA, 768001401AAA,
768001402AAA, 768001403AAA, 768001801AAA, 768001802AAA,
768001804AAA

DRAWER DIVIDERS FIXERS FIJADORES SEPARADORES CAJÓN

3419452

SPARE PART OF / RECAMBIO DE
768001001AAA, 768001002AAA, 768001004AAA, 768001401AAA,
768001402AAA, 768001403AAA, 768001801AAA, 768001802AAA,
768001804AAA

CABINET MOUNTING SET ACCESORIO SUJECCIÓN ARMARIO

3419450

SPARE PART OF / RECAMBIO DE
768000505AAA, 768000905AAA

CABINET HINGE BISAGRA MUEBLE/ARMARIO

3419108

SPARE PART OF / RECAMBIO DE
768000505BBB, 768000905BBB

HINGE BRAKE FRENOS BISAGRAS

3419445

SPARE PART OF / RECAMBIO DE
768000505AAA, 768000905AAA

GLASS SHELF ESTANTE VIDRIO

3419446

SPARE PART OF / RECAMBIO DE
768000505AAA

3419447

SPARE PART OF / RECAMBIO DE
768000905AAA

MIRROR DOOR PUERTA ESPEJO

3419448

SPARE PART OF / RECAMBIO DE
768000505AAA

3419449

SPARE PART OF / RECAMBIO DE
768000905AAA







Washbasins

Lavabos

- 196 **Compact**
 - 210 **Container**
 - 220 **Global Container**
 - 230 **Fancy**
 - 248 **Mix**
 - 256 **Modular**
 - 266 **The Grid**
-



Compact

Design by **Cosmic Studio**







Be part of the most personal moments.
The Compact bathroom collection achieves
this air of complicity, with dual functions
such as integrated storage drawers.

Ser partícipe de los momentos más personales.
Con la colección de lavabos Compact esta
complicidad se consigue, ofreciendo funciones
alternativas a la propia como los cajones
de almacenamiento integrados.





739120611
LEFT WASHBASIN/LATERAL STORAGE WITH TRAP
LAVABO IZQUIERDO/CAJÓN LATERAL CON SIFÓN
(40X20X40CM)





739120411
WASHBASIN/STORAGE WITH TRAP
LAVABO/CAJÓN CON SIFÓN
(32,5X32,5X25CM)





Solid Surface Biobased Washbasins

Cristalplant® Biobased Washbasins: unique compound material, technologically advanced, made up of 50% natural minerals (aluminium trihydrate -ATH- derived from bauxite) and 50% high-purity polyester bioresins. An inert, hypoallergenic, non-toxic material.

Solid Surface Biobased Washbasins

Lavabos de Cristalplant® Biobased: material compuesto, tecnológicamente avanzado y único, formado por un 50% de minerales naturales (trihidrato de aluminio -ATH- derivado de la bauxita) y un 50% de biorresinas de poliéster de gran pureza; se trata, por lo tanto, de un material inerte, hipoalérgico y no tóxico.

Plant resins: this is the first ecologically sustainable solid surface derived from plant resins mixed with highly pure natural minerals. Some 30% of the resin component, formerly of fossil origin, has been replaced with polyesters of plant origin from certified growers.

Resinas de origen vegetal: es el primer solid surface eco sostenible que deriva de materias primas resinosa de origen vegetal mezcladas con minerales inertes y naturales de extrema pureza. El 30% de la resina, anteriormente de origen fósil, ha sido substituida por poliésteres de origen vegetal procedentes de cultivos certificados.

100% recyclable: 100% of the material can be recovered.

Reciclable 100%: puede ser reemplazado y utilizado al final de la vida como inerte.

**CRISTALPLANT®
BIOBASED**

Less CO₂: 30% lighter which not only allows for easier manipulation and installation but produces less CO₂ than other similar products.

Menos CO₂: composición muy ligera, ha reducido su peso específico en un 30%, produciendo, por tanto, menos CO₂ con respecto a productos similares disponibles actualmente en el mercado, además de facilitar su manipulación e instalación.

Non-GMO: VOC (Volatile organic compounds) and BIO-BASED points awarded for the eco-sustainability certificate "Leadership in Energy and Environmental Design". This material has been certified as containing resins derived from vegetable starches and non-GMO corn. While the minimum requirement is 5%, these resins reach 12% in our product.

Sin OGM: es un material idóneo para obtener puntuación VOC (Compuestos Orgánicos Volátiles) y BIO-BASED para el certificado de eco-sostenibilidad "Leadership in Energy and Environmental Design". El material obtuvo el certificado que confirma que las resinas derivan de almidones vegetales y maíz sin OGM (organismos genéticamente modificados); en el material, dichas resinas superan incluso el 12%, cuando el requisito mínimo es normalmente del 5%.





Durable and recoverable: this material regains its original appearance using soapy water and a scrubber which will eliminate even cigarette burns. The durable and recoverable nature make this is an eco-compatible material.

Duradero y recuperable: material que puede recuperar completamente su aspecto original utilizando simplemente detergentes y estropajos abrasivos para eliminar incluso las quemaduras de cigarrillo. Sus propiedades de duración y capacidad de recuperación lo convierten en un material eco-compatible.

Highly fire resistant: the material is practically fireproof, with Class 1 fire resistance rating.

Alta resistencia al fuego: es prácticamente ignífugo, con certificado de resistencia al fuego Clase 1.



Easy wall fixing. Integrated drawer.

Fácil anclaje a pared. Cajón Integrado.

Optimum ultraviolet resistance: compact, non-porous, hygienic, resistant and pleasant to the touch thanks to the velvety finish, similar to natural stone.

Óptima resistencia a los rayos ultravioletas: es compacto, no poroso, higiénico, resistente y agradable al tacto gracias a su acabado aterciopelado, similar al de la piedra natural.

CRISTALPLANT

5
YEARS
GUARANTEE
AÑOS
GARANTÍA

Compact has successfully passed the high demanding tests of long last durability and resistance to extreme uses (static charge or impact testing) to assure long last durability of the product.

Toda la gama **Compact** ha superado con éxito exigentes tests de durabilidad y resistencia a usos extremos (cargas estáticas o test de impacto), para asegurar una larga vida al producto.



Compact Design by Cosmic Studio



WASHBASIN WITH TRAP
LAVABO CON SIFÓN

739 120 401

739 120 400
WITHOUT HOLE / SIN AGUJERO



INCH 12.8x12.8x5.9



WASHBASIN/STORAGE WITH TRAP
LAVABO/CAJÓN CON SIFÓN

739 120 411

739 120 410
WITHOUT HOLE / SIN AGUJERO

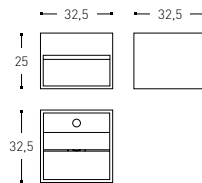

INCH 12.8x12.8x9.8



WASHBASIN/STORAGE WITH TRAP
LAVABO/CAJÓN CON SIFÓN

739 120 631

739 120 630
WITHOUT HOLE / SIN AGUJERO

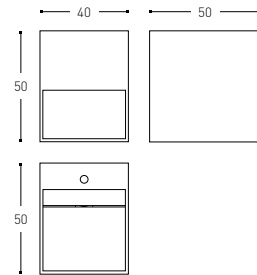

INCH 15.7x19.7x19.7



WASHBASIN WITH TRAP
LAVABO CON SIFÓN

739 120 601

739 120 600
WITHOUT HOLE / SIN AGUJERO

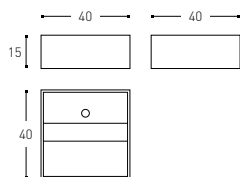

INCH 15.7x15.7x5.9



LEFT WASHBASIN/LATERAL STORAGE WITH TRAP
LAVABO IZQUIERDO/CAJÓN LATERAL CON SIFÓN

739 120 611

739 120 610
WITHOUT HOLE / SIN AGUJERO

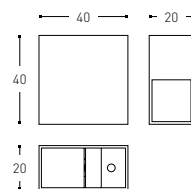

INCH 15.7x7.9x15.7



RIGHT WASHBASIN / LATERAL STORAGE WITH TRAP
LAVABO DERECHO/CAJÓN LATERAL CON SIFÓN

739 120 621

739 120 620
WITHOUT HOLE / SIN AGUJERO

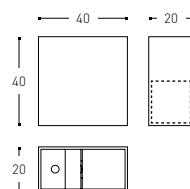

INCH 15.7x7.9x15.7



WASHBASIN/STORAGE WITH TRAP
LAVABO/CAJÓN CON SIFÓN

739 121 401

739 121 400
WITHOUT HOLE / SIN AGUJERO

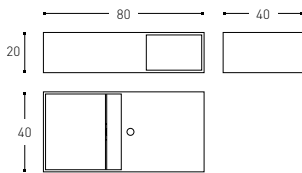

INCH 31.5x15.7x7.9



WASHBASIN/STORAGE WITH TRAP
LAVABO/CAJÓN CON SIFÓN

739 121 801

739 121 800
WITHOUT HOLE / SIN AGUJERO

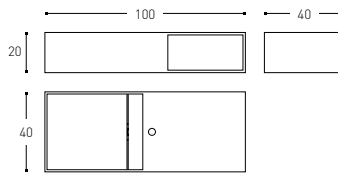

INCH 39.4x15.7x7.9



DOUBLE WASHBASIN WITH TRAP
LAVABO DOBLE CON SIFÓN

739 122 201

739 122 200
WITHOUT HOLE / SIN AGUJERO

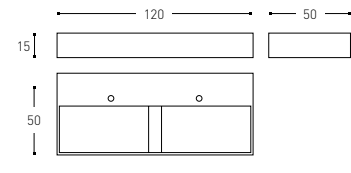

INCH 47.2x19.7x5.9



FREE DRAIN VALVE
VÁLVULA DESCARGA LIBRE

340 76 00

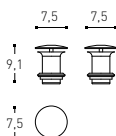

INCH 2.9x2.9x3.6



TRAP
SIFÓN

341 05 90

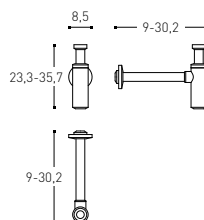

INCH 3.3x3.5-11.9x9.2-14



Compact

Design by **Cosmic Studio**

WASHBASIN/MIRROR MOUNTING SET
ACCESORIO SUJECIÓN LAVABO/ESPEJO

3307500

SPARE PART OF / RECAMBIO DE
739120400, 739120401, 739120410, 739120411, 739120600, 739120601,
739120610, 739120611, 739120620, 739120621, 739120630, 739120631,
739122200, 739122201

BASIN TRIPLE MOUNTING SET
ACCESORIO TRIPLE SUJECIÓN LAVABO

3410082

SPARE PART OF / RECAMBIO DE
739121400, 739121401, 739121800, 739121801

CLEANING SET
KIT DE LIMPIEZA

3410295

SPARE PART OF / RECAMBIO DE
739120400, 739120401, 739120410, 739120411, 739120600, 739120601,
739120610, 739120611, 739120620, 739120621, 739120630, 739120631,
739122200, 739122201, 739121400, 739121401, 739121800, 739121801

REPAIRING KIT
KIT REPARACIÓN

3410296

SPARE PART OF / RECAMBIO DE
739120400, 739120401, 739120410, 739120411, 739120600, 739120601,
739120610, 739120611, 739120620, 739120621, 739120630, 739120631,
739122200, 739122201, 739121400, 739121401, 739121800, 739121801

DRAIN COVER
TAPA DESAGÜE

3410658

(15,9x8,3 CM / INCH 6.2x3.3)

SPARE PART OF / RECAMBIO DE
739120610, 739120611, 739120620, 739120621

3410659

(28,4x8,2 CM / INCH 11.2x3.2)

SPARE PART OF / RECAMBIO DE
739120400, 739120401, 739120410, 739120411

3410660

(27,4x9 CM / INCH 10.8x3.5)

SPARE PART OF / RECAMBIO DE
739122200, 739122201

3410661

(36x8,2 CM / INCH 14.2x3.2)

SPARE PART OF / RECAMBIO DE
739120600, 739120601, 739120400, 739120401, 739120800, 739120801

3410662

(35,7x8,6 CM / INCH 14x3.4)

SPARE PART OF / RECAMBIO DE
739120630, 739120631



Container

Design by **Claramunt De Mas**









The reedition of the original collection with fine materials creates elegant and unique environments.

La reedición de la colección original con materiales nobles permite crear espacios elegantes y únicos.

775 06 10
WASHBASIN
LAVABO
(57X57X12,5 CM)

775 02 99
LEGS
PATAS
(100X3,2X77,5 CM)

775 80 15
TROLLEY
CARRO
(50X38,4X66,1 CM)



Container

Design by Claramunt De Mas





The washbasin follows the original shape and design faithfully. A piece that combines the latest CNC (computer numerical control) technology with the most exclusive materials: Carrara, Marquina and Brescia marble (matte and glossy finish).

El lavabo es fiel a la forma y al diseño original. Una pieza que combina la última tecnología CNC (control numérico) con los materiales mas exclusivos Mármol Carrara, Marquina y Brescia (en mate y brillo).



The washbasin stands on stainless steel legs in a glossy finish, offering towel rack function.

El lavabo descansa sobre unas patas de acero inoxidable en acabado brillo, que ofrecen la función de toallero.

MARBLE | **5**
YEARS
GUARANTEE
AÑOS
GARANTÍA

Container has successfully passed the high demanding tests of long last durability and resistance to extreme uses (static charge or impact testing) to assure long last durability of the product.

Toda la gama **Container** ha superado con éxito exigentes tests de durabilidad y resistencia a usos extremos (cargas estáticas o test de impacto), para asegurar una larga vida al producto.



Container

Design by **Claramunt De Mas**



CODE / CODIFICACIÓN

775 AA 10 CARRARA

775 BB 10 MARQUINA-BRECCIA

COLLECTION
COLECCIÓN

WASHBASIN
LAVABO

TYPE
MODELO

AA

WASHBASIN / LAVABO



05
MATTE CARRARA
CARRARA MATE



15
GLOSSY CARRARA
CARRARA BRILLO

BB

WASHBASIN / LAVABO



06
MATTE MARQUINA
MARQUINA MATE



16
GLOSSY MARQUINA
MARQUINA BRILLO



08
MATTE BRECCIA
BRECCIA MATE



18
GLOSSY BRECCIA
BRECCIA BRILLO

Container

Design by **Claramunt De Mas**

MOUNTING SET
ACCESORIO SUJECIÓN

3410653

SPARE PART OF / RECAMBIO DE
7750299

TRAP
SIFON

3410590

CHROME / CROMO

SPARE PART OF / RECAMBIO DE
755XX10

EXTENSION PIPE
TUBO ALARGO CROMO

2900113

CHROME / CROMO

SPARE PART OF / RECAMBIO DE
755XX10



Global Container

Design by **Claramunt De Mas**

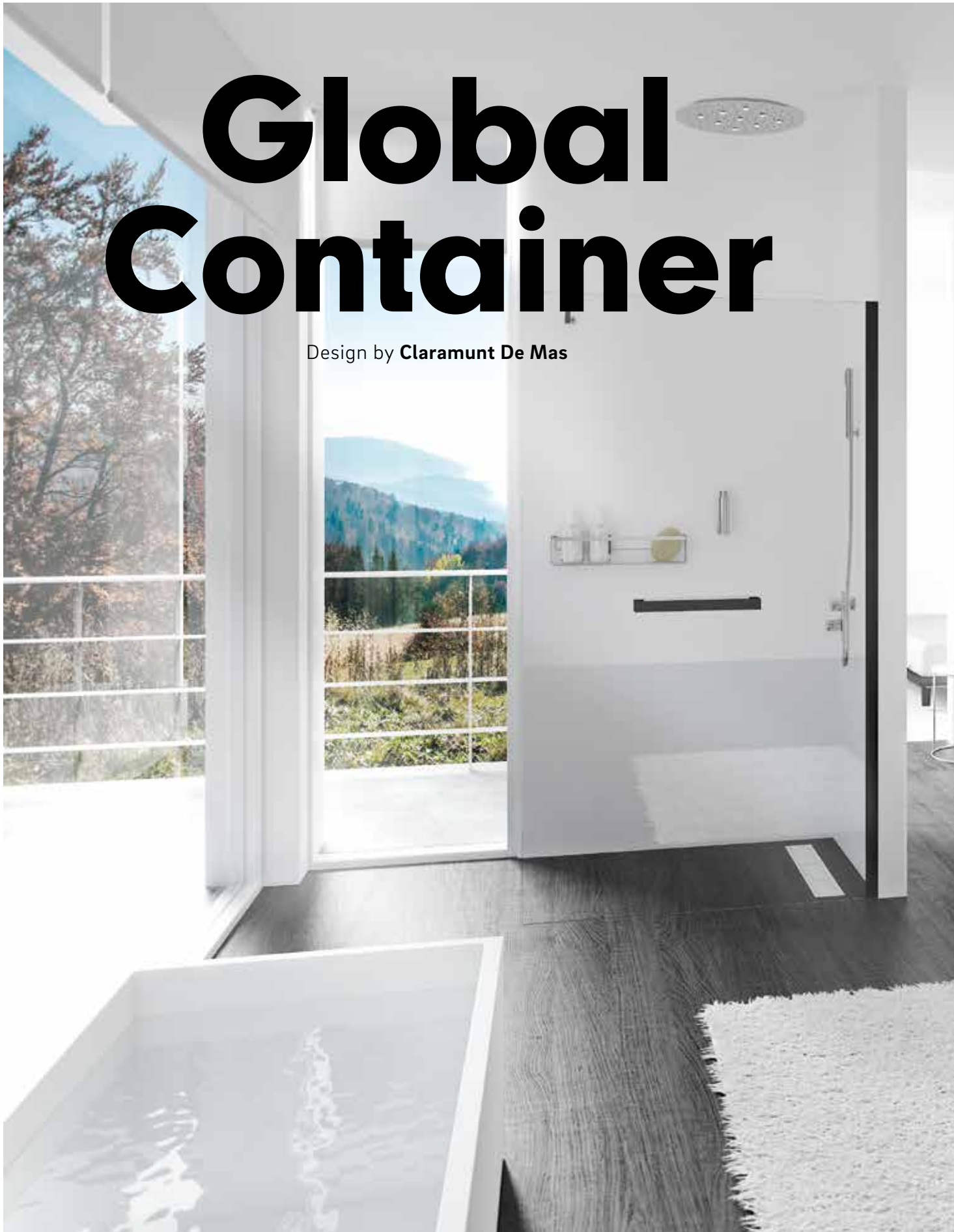





Simple lines and innovative concepts
reveal an ultra-contemporary collection.

Una colección ultra contemporánea
por sus líneas básicas y conceptos
innovadores.



755 01 64
TOWEL BAR
TOALLERO
(15 CM)

755 05 10
WASHBASIN
LAVABO
(55X55X13 CM)

755 89 03
SLIDING MIRROR
ESPEJO CORREDERO
(100 CM)

755 00 0902 102 102
1 DRAWER CABINET
MUEBLE 1 CAJÓN
(55X50 CM)





755 00 1302 126 126
1 DRAWER CABINET
MUEBLE 1 CAJÓN
(75X51X33 CM)

755 45 03
SLIDING MIRROR
ESPEJO CORREDERO
(100X12,5X85 CM)



Global Container

Design by Claramunt De Mas



Bowl-shaped basin which acts as a storage for water. The design itself encourages water savings in daily use. Basin overflow comprising four holes which function as a soap holder.

Seno en forma de bol, que sirve de depósito para almacenar el agua. El propio diseño fomenta el ahorro en las acciones cotidianas. Rebosadero de cuatro agujeros que tienen la función de jabonera.

Porcelain washbasin designed to be fitted to a wall, streamlined outline and large 55x55 cm dimensions.

Lavabo de porcelana diseñado para instalación a pared, de líneas depuradas y grandes dimensiones 55x55 cm.



Global Container has successfully passed the high demanding tests of long last durability and resistance to extreme uses (static charge or impact testing) to assure long last durability of the product.

Toda la gama **Global Container** ha superado con éxito exigentes tests de durabilidad y resistencia a usos extremos (cargas estáticas o test de impacto), para asegurar una larga vida al producto.



Option to add a towel rack, a towel shelf or both.

Posibilidad de añadir un toallero, un toallero repisa o ambas opciones a la vez.

Washbasins | Lavabos

CODE / CODIFICACIÓN

755 CC 65

GLOSSY CHROME / MATTE INOX
CROMO BRILLO / INOX MATE

COLLECTION
COLECCIÓN

FINISHES
ACABADOS

TYPE
MODELO

TOWEL BAR / TOALLEROS

CC



01
GLOSSY CHROME
CROMO BRILLO



03
MATTE INOX
INOX MATE



Global Container

Design by **Claramunt De Mas**



⊗
WASHBASIN + TRAP
LAVABO + SIFÓN

755 05 10

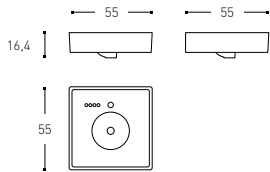

INCH 21.7x21.7x6.5



○
TOWEL RACK
TOALLERO

755 CC 64

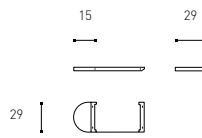

INCH 5.91x11.4



○
TOWEL RACK
TOALLERO

755 CC 65

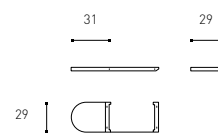

INCH 12.2x11.4



○
DOUBLE TOWEL RACK
TOALLERO DOBLE

755 CC 61

755 03 61

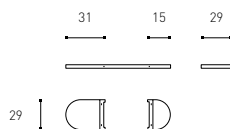

INCH 5.91+12.2x11.4



⊙
VALVE
VÁLVULA

341 03 87

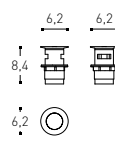

INCH 2.4x2.4x3.3

Spare parts | Recambios

WASHBASIN/MIRROR MOUNTING SET
ACCESORIO SUJECIÓN LAVABO/ESPEJO

3307500

SPARE PART OF / RECAMBIO DE
7550510

TRAP
SIFÓN

3410590

CHROME / CROMO

SPARE PART OF / RECAMBIO DE
7550510



Fancy

Design by **Cosmic Studio**









When less is more. Furniture with washbasin, wall and counter top washbasins. Compacted collection and also adaptable to all spaces and needs. Warm and refined forms, because of its rounded edges.

Cuando menos es más. Muebles con lavabo, lavabos a pared y de sobre-encimera. Colección compacta y a la vez adaptable a todos los espacios y necesidades. Formas cálidas y depuradas gracias a sus cantos redondeados.

747010803
GLOSSY TECKSTONE ABOVE-COUNTER WASHBASIN
LAVABO SOBRE ENCIMERA TECKSTONE BRILLO
(50X35X13)





747020600
MATTE TECKSTONE WASHBASIN
LAVABO TECKSTONE MATE
(40X20X15)

747020600131
1 DOOR CABINET FOR MATTE TECKSTONE WASHBASIN
MUEBLE 1 PUERTA CON LAVABO TECKSTONE MATE
(50X20X50)







747011004
GLOSSY TECKSTONE WASHBASIN
LAVABO TECKSTONE BRILLO
(60X45X15)

747021404
MATTE TECKSTONE WASHBASIN
LAVABO TECKSTONE MATE
(80X45X15)





747021000130
1 DOOR CABINET FOR MATTE TECKSTONE WASHBASIN
MUEBLE 1 PUERTA CON LAVABO TECKSTONE MATE
(60X20X60)

747021000
MATTE TECKSTONE WASHBASIN
LAVABO TECKSTONE MATE
(60X20X15)





Washbasins made of **Teckstone**, advanced formula composed of natural minerals (calcium carbonate and quartz) mixed with resin and covered by a Gelcoat Premium Maxguard. High resistance to UVA rays and attack of chemical products.

Lavabos de **Teckstone**, formulación avanzada compuesta de minerales naturales (carbonato de calcio y cuarzo) mezclados con resina y recubiertos con una película Gelcoat Premium Maxguard. Alta resistencia a los rayos UVA y ataque de productos químicos.

Chromed self-cleaning trap.

Sifón autolimpiante que evita la sedimentación de restos.



Rounded corners to let easy maintenance.

Ángulos redondeados que facilitan la limpieza.



High quality laminate finishes.

High resistance to abrasion, waterproof and easy maintenance. Colours unalterable.

Acabados laminados de alta gama.

Gran resistencia a la abrasión, impermeables y de fácil limpieza. Los tonos se mantienen inalterables a lo largo del tiempo.

Eco friendly: furniture made in Spain with

certified wood board (PEFC/FSC) following the chain of custody in forestry.

Producto ambientalmente responsable:

muebles fabricados en España con tableros de madera certificada (PEFC/FSC) conforme la cadena de custodia de productos forestales.



TECKSTONE | **5**
YEARS
GUARANTEE
AÑOS
GARANTÍA

Fancy has successfully passed the high demanding tests of long last durability and resistance to extreme uses (static charge or impact testing) to assure long last durability of the product.

Toda la gama **Fancy** ha superado con éxito exigentes tests de durabilidad y resistencia a usos extremos (cargas estáticas o test de impacto), para asegurar una larga vida al producto.



CODE / CODIFICACIÓN

747 AA 0402

747 AA 0600 BBB

COLLECTION
COLECCIÓN

WASHBASIN
LAVABO

TYPE
MODELO

STRUCTURE AND
DOOR COLOUR
COLOR CUERPO
Y PUERTA

WASHBASIN / LAVABO

AA



01
GLOSSY WHITE
BLANCO BRILLO



02
MATTE WHITE
BLANCO MATE

TECHNICALS / TÉCNICOS

BBB

STRUCTURE AND DOOR COLOUR
COLOR CUERPO Y PUERTA

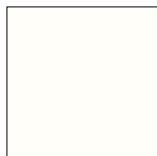

129
MATTE WHITE
BLANCO MATE



130
ANTHRACITE
ANTRACITA



131
OAK
ROBLE



132
SLATE OAK
ROBLE PIZARRA



1 LEFT DOOR CABINET WITH LEFT WASHBASIN
MUEBLE CON LAVABO IZDO 1 PUERTA IZDA

747 AA 0600 BBB **

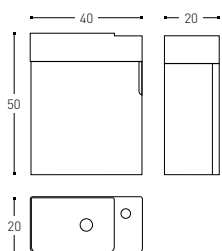

INCH 15.7x7.9x19.7



1 RIGHT DOOR CABINET WITH RIGHT WASHBASIN
MUEBLE CON LAVABO DCHO 1 PUERTA DCHA

747 AA 0601 BBB **

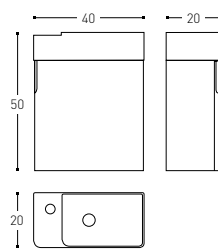

INCH 15.7x7.9x19.7



2 DOORS CABINET WITH LEFT WASHBASIN
MUEBLE CON LAVABO IZDO 2 PUERTAS

747 AA 1000 BBB **

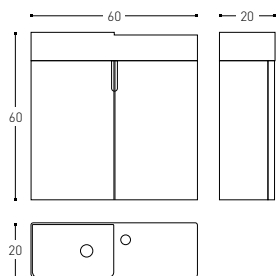

INCH 23.6x7.9x23.6



2 DOORS CABINET WITH RIGHT WASHBASIN
MUEBLE CON LAVABO DCHO 2 PUERTAS

747 AA 1001 BBB **

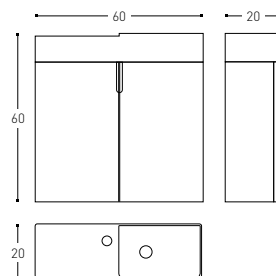

INCH 23.6x7.9x23.6

** THE USE OF 3407600 FREE DRAIN VALVE IS RECOMMENDED

** RECOMENDAMOS EL USO DE LA VÁLVULA DE DESCARGA LIBRE 3407600



LEFT WASHBASIN WITHOUT TRAP
LAVABO IZQUIERDO SIN SIFON

747 AA 0600 */**

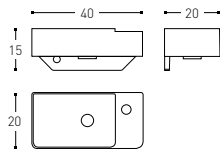

INCH 15.7x7.9x5.9



RIGHT WASHBASIN WITHOUT TRAP
LAVABO DERECHO SIN SIFON

747 AA 0601 */**

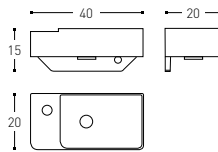

INCH 15.7x7.9x5.9



LEFT WASHBASIN WITHOUT TRAP
LAVABO IZQUIERDO SIN SIFON

747 AA 1000 */**

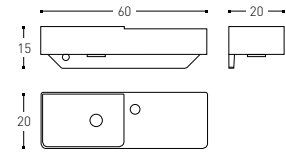

INCH 23.6x7.9x5.9



CORNER WASHBASIN WITHOUT TRAP
LAVABO RINCON SIN SIFON

747 AA 0402 */**

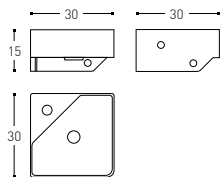

INCH 11.8x11.8x5.9



ABOVE-COUNTER WASHBASIN WITHOUT TRAP
LAVABO SOBRE ENCIMERA SIN SIFON

747 AA 0803 */***

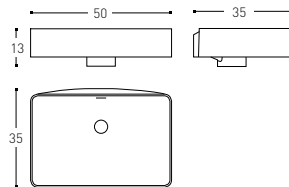

INCH 19.7x13.8x5.1



RIGHT WASHBASIN WITHOUT TRAP
LAVABO DERECHO SIN SIFON

747 AA 1001 */**

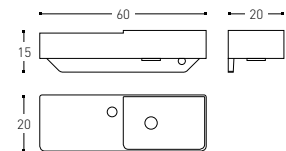

INCH 23.6x7.9x5.9



WASHBASIN WITHOUT TRAP
LAVABO SIN SIFÓN

747 AA 1004 */***

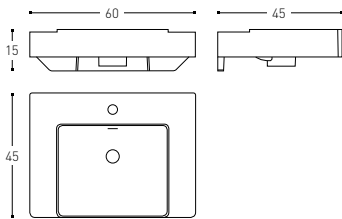

INCH 23.6x17.7x5.9



WASHBASIN WITHOUT TRAP
LAVABO SIN SIFÓN

747 AA 1404 */***

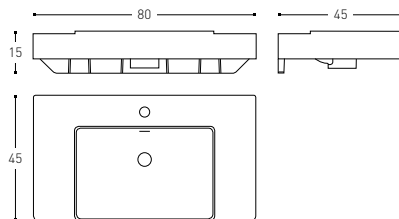

INCH 31.5x17.7x5.9



TRAP
SIFÓN

341 05 90

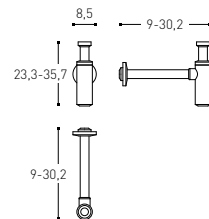

INCH 3.3x3.5-11.9x9.2-14.1



FREE DRAIN VALVE
VÁLVULA DESCARGA LIBRE

340 76 00

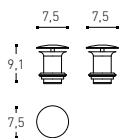

INCH 2.9x2.9x3.6



VALVE
VÁLVULA

341 03 87

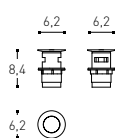

INCH 2.4x2.4x3.3

* THE USE OF 3410590 TRAP IS RECOMMENDED
* RECOMENDAMOS EL USO DEL SIFÓN 3410590

** THE USE OF 3407600 FREE DRAIN VALVE IS RECOMMENDED
** RECOMENDAMOS EL USO DE LA VÁLVULA DE DESCARGA LIBRE 3407600

*** THE USE OF 3410387 POP-UP VALVE IS RECOMMENDED
*** RECOMENDAMOS EL USO DE LA VÁLVULA CLICK CLACK 3410387

WASHBASIN/MIRROR MOUNTING SET
ACCESORIO SUJECIÓN LAVABO/ESPEJO

3410610

SPARE PART OF / RECAMBIO DE
747AA0600BBB, 747AA0601BBB, 747AA1000BBB, 747AA1001BBB, 747AA0600,
747AA0601, 747AA402, 744AA0803, 747AA1000, 747AA1001, 747AA1004,
747AA1404

CABINET WITH WASHBASIN MOUNTING SET
ACCESORIO SUJECIÓN MUEBLE CON LAVABO

3410611

SPARE PART OF / RECAMBIO DE
747AA0600BBB, 747AA0601BBB, 747AA1000BBB, 747AA1001BBB

TRAP
SIFÓN

3410590

CHROME / CROMO

SPARE PART OF / RECAMBIO DE
747AA0600BBB, 747AA0601BBB, 747AA1000BBB, 747AA1001BBB, 747AA0600,
747AA0601, 747AA402, 744AA0803, 747AA1000, 747AA1001, 747AA1004,
747AA1404

FLANGE
EMBELLECEDOR

3419127

CHROME / CROMO

SPARE PART OF / RECAMBIO DE
747AA0600BBB, 747AA0601BBB, 747AA1000BBB, 747AA1001BBB, 747AA0600,
747AA0601, 747AA402, 744AA0803, 747AA1000, 747AA1001, 747AA1004,
747AA1404

RIGHT DOOR 40 CM
PUERTA DERECHA 40 CM

3410592

MATTE WHITE-CHROME / BLANCO MATE-CROMO

SPARE PART OF / RECAMBIO DE
747AA0601129

3410593

ANTHRACITE / ANTRACITA

SPARE PART OF / RECAMBIO DE
747AA0601130

3410594

OAK / ROBLE

SPARE PART OF / RECAMBIO DE
747AA0601131

3410595

SLATE OAK TECHNICAL / ROBLE PIZARRA TECNICO

SPARE PART OF / RECAMBIO DE
747AA0601132

LEFT DOOR 40 CM
PUERTA IZQUIERDA 40 CM

3410600

MATTE WHITE-CHROME / BLANCO MATE-CROMO

SPARE PART OF / RECAMBIO DE
747AA0600129

3410601

ANTHRACITE / ANTRACITA

SPARE PART OF / RECAMBIO DE
747AA0600130

3410602

OAK / ROBLE

SPARE PART OF / RECAMBIO DE
747AA0600131

3410603

SLATE OAK TECHNICAL / ROBLE PIZARRA TECNICO

SPARE PART OF / RECAMBIO DE
747AA0600132

RIGHT DOOR
PUERTA DERECHA

3410596

MATTE WHITE-CHROME / BLANCO MATE-CROMO

SPARE PART OF / RECAMBIO DE
747AA1001129

3410597

ANTHRACITE / ANTRACITA

SPARE PART OF / RECAMBIO DE
747AA1001130

3410598

OAK / ROBLE

SPARE PART OF / RECAMBIO DE
747AA1001131

3410599

SLATE OAK TECHNICAL / ROBLE PIZARRA TECNICO

SPARE PART OF / RECAMBIO DE
747AA1001132

LEFT DOOR
PUERTA IZQUIERDA

3410604

MATTE WHITE-CHROME / BLANCO MATE-CROMO

SPARE PART OF / RECAMBIO DE
747AA1000129

3410605

ANTHRACITE / ANTRACITA

SPARE PART OF / RECAMBIO DE
747AA1000130

3410606

OAK / ROBLE

SPARE PART OF / RECAMBIO DE
747AA1000131

3410607

SLATE OAK TECHNICAL / ROBLE PIZARRA TECNICO

SPARE PART OF / RECAMBIO DE
747AA1000132

HINGE
BISAGRA

3410591

SPARE PART OF / RECAMBIO DE
747AA0600BBB, 747AA0601BBB, 747AA1000BBB, 747AA1001BBB

SHELF
ESTANTE

3410609

SPARE PART OF / RECAMBIO DE
747AA1000BBB, 747AA1001BBB

REAR TIMBER
TRASERA MUEBLE

3410608

SPARE PART OF / RECAMBIO DE
747AA1000BBB, 747AA1001BBB



Mix

Design by **Martín Azúa**



723120601
WASHBASIN WITH 2 DRAWERS AND TRAP
LAVABO CON 2 CAJONES Y SIFÓN
(40X26,5X40 CM)



The combination of organic
and compact gives the perfect result.
A collection with the tranquillity
and wellbeing of the bathroom
in mind.

La mezcla entre lo orgánico y lo
compacto da el resultado perfecto.
Una colección especialmente ideada
para el relax y el bienestar en el
espacio de baño.





Solid Surface Biobased Washbasins

Cristalplant® Biobased Washbasins: unique compound material, technologically advanced, made up of 50% natural minerals (aluminium trihydrate -ATH- derived from bauxite) and 50% high-purity polyester bioresins. An inert, hypoallergenic, non-toxic material.

Solid Surface Biobased Washbasins

Lavabos de Cristalplant® Biobased: material compuesto, tecnológicamente avanzado y único, formado por un 50% de minerales naturales (trihidrato de aluminio -ATH- derivado de la bauxita) y un 50% de biorresinas de poliéster de gran pureza; se trata, por lo tanto, de un material inerte, hipoalérgico y no tóxico.

Plant resins: this is the first ecologically sustainable solid surface derived from plant resins mixed with highly pure natural minerals. Some 30% of the resin component, formerly of fossil origin, has been replaced with polyesters of plant origin from certified growers.

Resinas de origen vegetal: es el primer solid surface eco sostenible que deriva de materias primas resinosa de origen vegetal mezcladas con minerales inertes y naturales de extrema pureza. El 30% de la resina, anteriormente de origen fósil, ha sido substituida por poliésteres de origen vegetal procedentes de cultivos certificados.

100% recyclable: 100% of the material can be recovered.

Reciclable 100%: puede ser reemplazado y utilizado al final de la vida como inerte.

CRISTALPLANT®
BIOBASED

Less CO₂: 30% lighter which not only allows for easier manipulation and installation but produces less CO₂ than other similar products.

Menos CO₂: composición muy ligera, ha reducido su peso específico en un 30%, produciendo, por tanto, menos CO₂ con respecto a productos similares disponibles actualmente en el mercado, además de facilitar su manipulación e instalación.

Non-GMO: VOC (Volatile organic compounds) and BIO-BASED points awarded for the eco-sustainability certificate "Leadership in Energy and Environmental Design". This material has been certified as containing resins derived from vegetable starches and non-GMO corn. While the minimum requirement is 5%, these resins reach 12% in our product.

Sin OGM: es un material idóneo para obtener puntuación VOC (Compuestos Orgánicos Volátiles) y BIO-BASED para el certificado de eco-sostenibilidad "Leadership in Energy and Environmental Design". El material obtuvo el certificado que confirma que las resinas derivan de almidones vegetales y maíz sin OGM (organismos genéticamente modificados); en el material, dichas resinas superan incluso el 12%, cuando el requisito mínimo es normalmente del 5%.





Durable and recoverable: this material regains its original appearance using soapy water and a scrubber which will eliminate even cigarette burns. The durable and recoverable nature make this is an eco-compatible material.

Duradero y recuperable: material que puede recuperar completamente su aspecto original utilizando simplemente detergentes y estropajos abrasivos para eliminar incluso las quemaduras de cigarrillo. Sus propiedades de duración y capacidad de recuperación lo convierten en un material eco-compatible.

Integrated soap dish and drawer.
Optional towel holder incorporated.

Jabonera y cajón integrados.
Toallero incorporado opcional.



Highly fire resistant: the material is practically fireproof, with Class 1 fire resistance rating.

Alta resistencia al fuego: es prácticamente ignífugo, con certificado de resistencia al fuego Clase 1.

Optimum ultraviolet resistance: compact, non-porous, hygienic, resistant and pleasant to the touch thanks to the velvety finish, similar to natural stone.

Óptima resistencia a los rayos ultravioletas: es compacto, no poroso, higiénico, resistente y agradable al tacto gracias a su acabado aterciopelado, similar al de la piedra natural.

CRISTALPLANT

5

YEARS
GUARANTEE

AÑOS
GARANTÍA

Mix has successfully passed the high demanding tests of long last durability and resistance to extreme uses (static charge or impact testing) to assure long last durability of the product.

Toda la gama **Mix** ha superado con éxito exigentes tests de durabilidad y resistencia a usos extremos (cargas estáticas o test de impacto), para asegurar una larga vida al producto.





WASHBASIN WITH TOWEL RACK, 2 DRAWERS AND TRAP
LAVABO CON TOALLERO, 2 CAJONES Y SIFÓN

723 120 611

723 120 610
WITHOUT HOLE / SIN AGUJERO

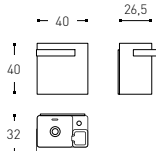

INCH 15.7x10.4x15.7



WASHBASIN WITH 2 DRAWERS AND TRAP
LAVABO CON 2 CAJONES

723 120 601

723 120 600
WITHOUT HOLE / SIN AGUJERO

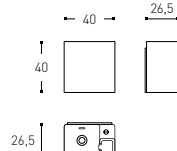

INCH 15.7x10.4x15.7



WASHBASIN WITH TOWEL RACK, 1 DRAWER AND TRAP
LAVABO CON TOALLERO, 1 CAJÓN Y SIFÓN

723 121 411

723 121 410
WITHOUT HOLE / SIN AGUJERO

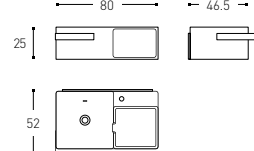

INCH 31.5x18.3x9.9



WASHBASIN WITH 1 DRAWER AND TRAP
LAVABO CON 1 CAJÓN

723 121 401

723 121 400
WITHOUT HOLE / SIN AGUJERO

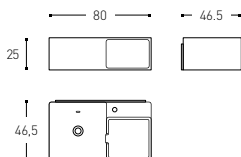

INCH 31.5x18.3x9.9



FREE-STANDING BATHTUB
BAÑERA FREE-STANDING

723 05 05

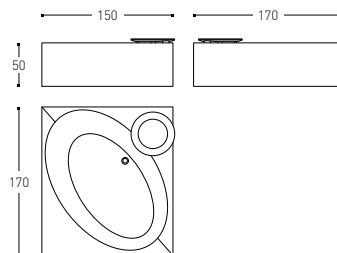

INCH 59x66.9x19.7



TRAP
SIFÓN

341 05 90

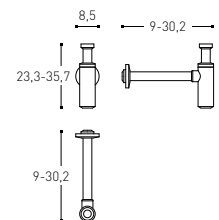

INCH 3.3x3.5-11.9x9.2-14

Spare parts | Recambios

WASHBASIN/MIRROR MOUNTING SET
ACCESORIO SUJECIÓN LAVABO/ESPEJO

3410619

SPARE PART OF / RECAMBIO DE
**723120600, 723120601, 723120610, 723120611, 723121400, 723121401,
723121410, 723121411**

VALVE
VÁLVULA

3410387

CHROME / CROMO

SPARE PART OF / RECAMBIO DE
723120611, 723120601, 723121411, 723121401

TOWEL RACK
TOALLERO

3419021

SPARE PART OF / RECAMBIO DE
723120610, 723120611, 723121410, 723121411

CLEANING SET
KIT DE LIMPIEZA

3410295

SPARE PART OF / RECAMBIO DE
**723120600, 723120601, 723120610, 723120611, 723121400, 723121401,
723121410, 723121411, 7230505**

REPAIRING KIT
KIT REPARACIÓN

3410296

SPARE PART OF / RECAMBIO DE
**723120600, 723120601, 723120610, 723120611, 723121400, 723121401,
723121410, 723121411**

BATHTUB ACCES COVER
PLACA DE ACCESO BAÑERA

3410428

SPARE PART OF / RECAMBIO DE
7230505

BATHTUB VALVE
VÁLVULA PARA BAÑERA

3419111

SPARE PART OF / RECAMBIO DE
7230505

REPAIRING KIT CRISTALPLANT
KIT REPARACIÓN CRISTALPLANT

3410729

SPARE PART OF / RECAMBIO DE
7230505



Modular

Design by **Àlex Armenter**









The washbasins combined with Modular furniture are the synthesis of shapes to achieve an overall design full of personality.

Los lavabos combinables con los muebles Modular se han diseñado para conseguir un diseño global lleno de personalidad.

744 111 003
COUNTERTOP WASHBASIN
LAVABO ENCIMERA
(58X37X213CM)





Counter-top washbasins that are 13cm high, made of Cristalplant®. Available in three different shapes: round, square and rectangular.

Lavabos de sobre-encimera con una altura de 13 cm y realizados en Cristalplant®. Disponibles en tres formas: redonda, cuadrada y rectangular.

Cristalplant® a technologically advanced and unique compound, made up of high percentage of mineral extenders from nature (ATH derived from bauxite) as well as a small one of high-pureness polyester and acrylic polymers. Strongly UV-resistant.

Cristalplant®, material compuesto por un porcentaje elevado de minerales naturales (trihidrato de aluminio –ATH- derivado de la bauxita) y un bajo porcentaje de polímeros poliésteres y acrílicos de gran pureza. Óptima resistencia a los rayos ultravioletas.

CRISTALPLANT

5

YEARS
GUARANTEE
AÑOS
GARANTÍA



Built-in washbasins, available in white or black with matte or glossy finishes. Pieces with deep sink, avoiding splashing.

Lavabos encastrados disponibles en blanco o negro con acabados mate o brillo. Piezas con seno profundo que evita salpicaduras.

Vit-tech: top quality glass-lined steel (10 year guarantee). Material 100% recyclable. High chemical, mechanic and corrosion resistance. Easy clean.

Vit-tech: acero vitrificado de alta calidad (garantía 10 años). Material 100% Reciclable. Alta resistencia química, mecánica y a la corrosión. Fácil limpieza.

VIT-TECH | **10**
YEARS
GUARANTEE
AÑOS
GARANTÍA

Modular

Design by Àlex Armenter

CODE / CODIFICACIÓN

744 11 06 01 CRISTALPLANT

744 AA 00 00 VIT-TECH

COLLECTION
COLECCIÓN

FINISH
ACABADO

TYPE
MODELO

FINISHES / ACABADOS

11

CRISTALPLANT



11
MATTE WHITE
BLANCO MATE

AA

VIT-TECH



03
GLOSSY WHITE
BLANCO BRILLO



04
MATTE WHITE
BLANCO MATE



05
GLOSSY BLACK
NEGRO BRILLO



06
MATTE BLACK
NEGRO MATE



COUNTERTOP WASHBASIN
LAVABO DE SOBRE-ENCIMERA

744 11 06 01

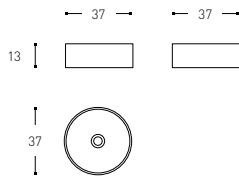

INCH 14.6x14.6x5.1



COUNTERTOP WASHBASIN
LAVABO DE SOBRE-ENCIMERA

744 11 06 02

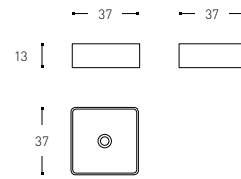

INCH 14.6x14.6x5.1



COUNTERTOP WASHBASIN
LAVABO DE SOBRE-ENCIMERA

744 11 10 03

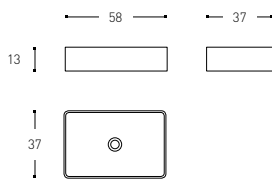

INCH 22.8x14.6x5.1



WASHBASIN
LAVABO

744 03 00 00
GLOSSY WHITE / BLANCO BRILLO

744 AA 00 00
MATTE WHITE / BLANCO MATE
GLOSSY BLACK / NEGRO BRILLO
MATTE BLACK / NEGRO MATE

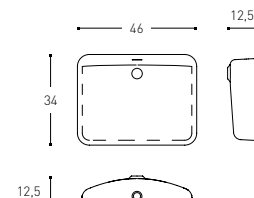

INCH 18.1x4.9x13.4

Modular

Design by Àlex Armenter



KIT VALVE & OVERFLOW TANK FLANGE
FOR BUILT-IN WASHBASINS
KIT VÁLVULA Y EMBELLECEDOR REBOSADERO
PARA LAVABOS DE ENCASTRAR

34105 58
CHROME / CROMO

34105 65
MATTE WHITE-CHROME / BLANCO MATE-CROMO

34105 66
GLOSSY WHITE / BLANCO BRILLO

34105 67
MATTE BLACK / NEGRO MATE

34105 68
GLOSSY BLACK / NEGRO BRILLO

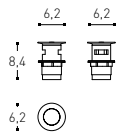

INCH 2.4x2.4x3.3



FREE DRAIN VALVE
FOR COUNTERTOP WASHBASIN
VÁLVULA DESCARGA LIBRE
PARA LAVABO DE SOBRE-ENCIMERA

34076 00
CHROME / CROMO

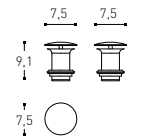

INCH 2.9x2.9x3.6



TRAP
SIFÓN

34105 90

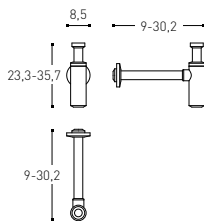

INCH 3.3x3.5-11.9x9.2-14

Spare parts | Recambios

CLEANING SET
KIT DE LIMPIEZA

3410295

SPARE PART OF / RECAMBIO DE

REPAIRING KIT
KIT REPARACIÓN

3410296

SPARE PART OF / RECAMBIO DE



The Grid

Design by **Ricard Ferrer**





The Grid

Design by Ricard Ferrer



Non-GMO: VOC (Volatile organic compounds) and BIO-BASED points awarded for the eco-sustainability certificate "Leadership in Energy and Environmental Design". This material has been certified as containing resins derived from vegetable starches and non-GMO corn. While the minimum requirement is 5%, these resins reach 12% in our product. 100% Recyclable: can be replaced and used at the end of life as inert.

Sin OGM: es un material idóneo para obtener puntuación VOC (Compuestos Orgánicos Volátiles) y BIO-BASED para el certificado de eco-sostenibilidad "Leadership in Energy and Environmental Design". El material obtuvo el certificado que confirma que las resinas derivan de almidones vegetales y maíz sin OGM (organismos genéticamente modificados); en el material, dichas resinas superan incluso el 12%, cuando el requisito mínimo es normalmente del 5%. Reciclable 100%: puede ser reemplazado y utilizado al final de la vida como inerte.



Plant resins: this is the first ecologically sustainable solid surface derived from plant resins mixed with highly pure natural minerals. Some 30% of the resin component, formerly of fossil origin, has been replaced with polyesters of plant origin from certified growers.

Resinas de origen vegetal: es el primer solid surface eco sostenible que deriva de materias primas resinosas de origen vegetal mezcladas con minerales inertes y naturales de extrema pureza. El 30% de la resina, anteriormente de origen fósil, ha sido substituida por poliésteres de origen vegetal procedentes de cultivos certificados.



Practical container to store water for various purposes, such as shaving.

Práctico contenedor para retener el agua para ciertos usos como el afeitado.



Less CO₂ : 30% lighter which not only allows for easier manipulation and installation but produces less CO₂ than other similar products.

Menos CO₂: composición muy ligera, ha reducido su peso específico en un 30%, produciendo, por tanto, menos CO₂ con respecto a productos similares disponibles actualmente en el mercado, además de facilitar su manipulación e instalación.



WASHBASIN WITH WATER CONTAINER
LAVABO CON CONTENEDOR DE AGUA

768 12 10 03
60 CM

768 12 14 03
80 CM

768 12 18 03
100 CM

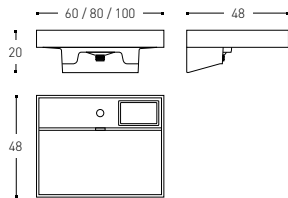

INCH 23.6/31.5/39.4x18.9x7.9



WASHBASIN WITH WATER CONTAINER WITHOUT TAP HOLE
LAVABO CON CONTENEDOR DE AGUA SIN AGUJERO

768 12 10 02
60 CM

768 12 14 02
80 CM

768 12 18 02
100 CM

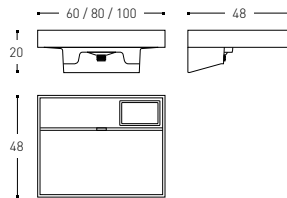

INCH 23.6/31.5/39.4x18.9x7.9



TRAP
SIFÓN

341 05 90

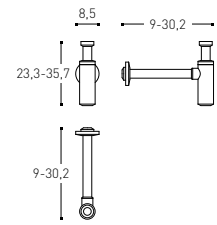

INCH 3.3x3.5-11.9x9.2-14

Spare parts | Recambios

DRYWALL ANCHOR UX-R Ø6X35MM
TACO PLADUR UX-R Ø6X35MM

3410636

SPARE PART OF / RECAMBIO DE

CLEANING SET
KIT DE LIMPIEZA

3410295

SPARE PART OF / RECAMBIO DE
7628121003, 7680121403, 768121803, 768121120

WASHBASIN/MIRROR MOUNTING SET
ACCESORIO SUJECION LAVABO

3307500

SPARE PART OF / RECAMBIO DE
7628121003, 7680121403, 768121803, 768121120

REPAIRING KIT
KIT REPARACIÓN

3410296

SPARE PART OF / RECAMBIO DE
7628121003, 7680121403, 768121803, 768121120

PREVEX TRAP
SIFÓN PREVEX

3419456

SPARE PART OF / RECAMBIO DE
768001001AAA, 768001002AAA, 768001004AAA, 768001401AAA, 768001402AAA, 768001404AAA, 768001801AAA, 768001802AAA, 768001804AAA

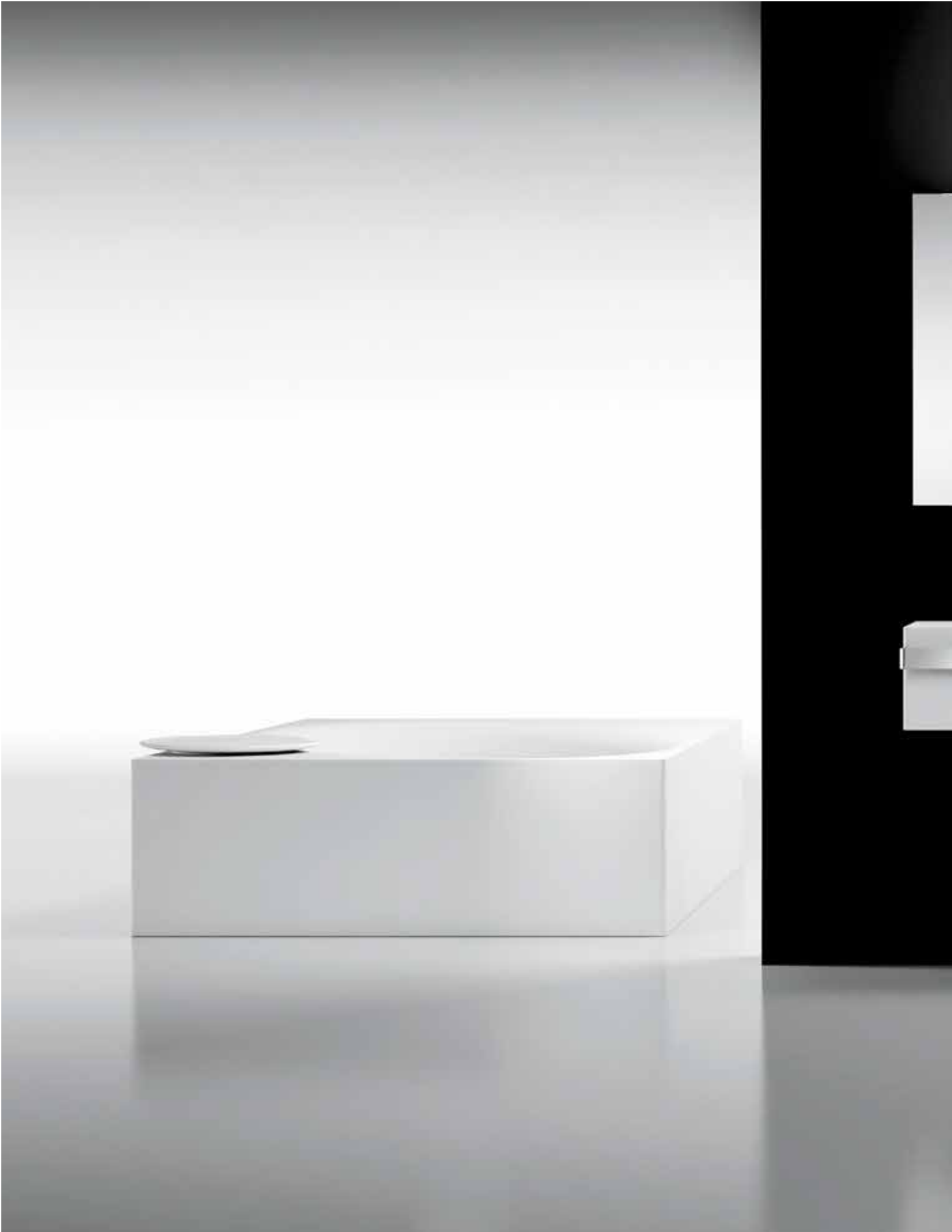

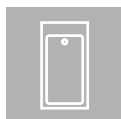

Bathtubs

Bañeras

272 **Mix**
276 **Up Grade**



Mix

Design by **Martín Azúa**



Bathtub designed
for total wellbeing.

Bañera de grandes
dimensiones pensada
para conseguir
el máximo bienestar.





CRISTALPLANT

5
YEARS
GUARANTEE
AÑOS
GARANTÍA

Cristalplant®; a technologically advanced and unique compound, made up of high percentage of mineral extenders from nature (ATH derived from bauxite) as well as a small one of high-pureness polyester and acrylic polymers. Strongly UV-resistant.

Cristalplant®, material compuesto por un porcentaje elevado de minerales naturales (trihidrato de aluminio –ATH- derivado de la bauxita) y un bajo porcentaje de polímeros poliésteres y acrílicos de gran pureza. Óptima resistencia a los rayos ultravioletas.

Mix has successfully passed the high demanding tests of long last durability and resistance to extreme uses (static charge or impact testing) to assure long last durability of the product.

Toda la gama **Mix** ha superado con éxito exigentes tests de durabilidad y resistencia a usos extremos (cargas estáticas o test de impacto), para asegurar una larga vida al producto.

Spare parts | Recambios



●
FREE-STANDING BATHTUB
BAÑERA FREE-STANDING

723 05 05

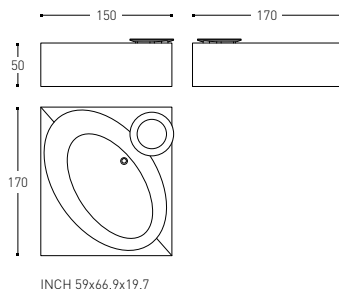

BATHTUB ACCES COVER
PLACA DE ACCESO BAÑERA

3410428

SPARE PART OF / RECAMBIO DE
7230505

BATHTUB VALVE
VÁLVULA PARA BAÑERA

3419111

SPARE PART OF / RECAMBIO DE
7230505

REPAIRING KIT CRISTALPLANT
KIT REPARACIÓN CRISTALPLANT

3410729

SPARE PART OF / RECAMBIO DE
7230505

CLEANING SET CRISTALPLANT, BIOBASED
KIT DE LIMPIEZA CRISTALPLANT, BIOBASED

3410295

SPARE PART OF / RECAMBIO DE
7230505



Up Grade

Design by **Cosmic Studio**

Refined lines, essential forms and generous shapes that offer singular aesthetics. Pieces that convey sensations of a relaxed amplitude.

Líneas depuradas, formas esenciales y dimensiones generosas que proporcionan una singular estética. Piezas que transmiten sensaciones de relajada amplitud.





Cristalplant®; a technologically advanced and unique compound, made up of high percentage of mineral extenders from nature (ATH derived from bauxite) as well as a small one of high-pureness polyester and acrylic polymers. Strongly UV-resistant.

Cristalplant®, material compuesto por un porcentaje elevado de minerales naturales (trihidrato de aluminio –ATH- derivado de la bauxita) y un bajo porcentaje de polímeros poliésteres y acrílicos de gran pureza. Óptima resistencia a los rayos ultravioletas.

Mix has successfully passed the high demanding tests of long last durability and resistance to extreme uses (static charge or impact testing) to assure long last durability of the product.

Toda la gama **Mix** ha superado con éxito exigentes tests de durabilidad y resistencia a usos extremos (cargas estáticas o test de impacto), para asegurar una larga vida al producto.



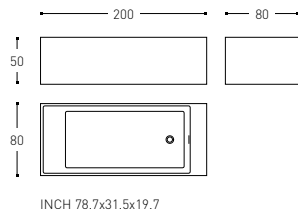

FREE-STANDING BATHTUB
 BAÑERA FREE-STANDING

736 05 15



INCH 78.7x31.5x19.7



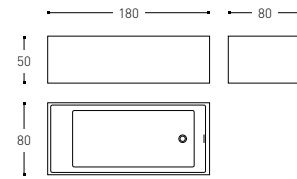

FREE-STANDING BATHTUB
 BAÑERA FREE-STANDING

736 05 16



INCH 70.9x31.5x19.7



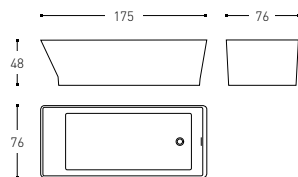

FREE-STANDING BATHTUB
 BAÑERA FREE-STANDING

736 05 18



INCH 68.9x29.9x18.9



BUILT-IN BATHTUB
 BAÑERA PARA EMPOTRAR

736 05 17

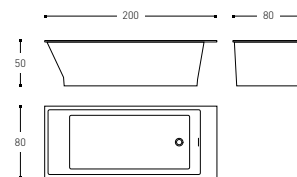

INCH 78.7x31.5x19.7



Up Grade

Design by **Cosmic Studio**

CLEANING SET CRISTALPLANT BIOBASED
KIT DE LIMPIEZA CRISTALPLANT BIOBASED

3410295

SPARE PART OF / RECAMBIO DE
7360515, 7360516, 7360518, 7360517

REPAIRING KIT CRISTALPLANT
KIT REPARACIÓN CRISTALPLANT

3410729

SPARE PART OF / RECAMBIO DE
7360515, 7360516, 7360518, 7360517

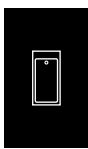





Faucets

Grifería

284 **Control**
290 **Flow**



Control

Design by **Xavier Claramunt**







Features

Flow limiter: 8l/min.
Progressive flow and temperature.
Hidden aerator.

Características

Limitador de caudal: 8l/min.
Caudal y temperatura progresivos.
Aireador oculto.

Extraordinarily subtle design
and high technology to fulfil a
simple and elementary concept.

Diseño extraordinariamente sutil
y alta tecnología al servicio de un
concepto simple y elemental.



⊙
SINGLE LEVER BASIN MIXER FAUCET
GRIFO MONOMANDO LAVABO

248 01 02

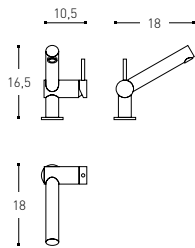

INCH 4.1x7.1x6.5



⊙
SINGLE LEVER BASIN/BIDET MIXER FAUCET
MONOMANDO LAVABO/BIDÉ

248 01 04

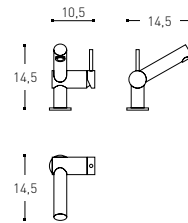

INCH 4.1x5.7x5.7



⊙
BUILT IN SINGLE LEVER BASIN MIXER FAUCET
MONOMANDO LAVABO PARED

248 01 03

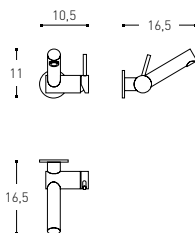

INCH 4.1x6.5x4.3



⊙
BUILT IN SINGLE LEVER SHOWER MIXER FAUCET
MONOMANDO SEMIEMPOTRADO DUCHA

248 01 06

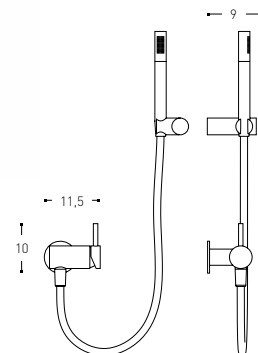

Control

Design by **Xavier Claramunt**



⊙
BUILT IN SINGLE LEVER BATH/SHOWER
MIXER FAUCET
MONOMANDO SEMIEMPOTRADO
BAÑO / DUCHA

248 01 07

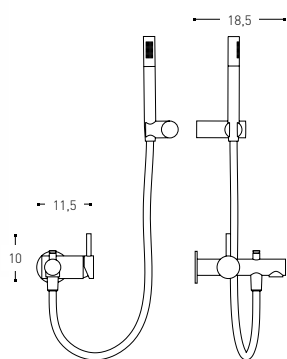

Spare parts | Recambios

CERAMIC CARTRIDGE BASIN MIXER FAUCET
CARTUCHO CERÁMICA MONOMANDO LAVABO

3406900

SPARE PART OF / RECAMBIO DE
2480102, 2480103, 2480104

CERAMIC CARTRIDGE BATH/SHOWER MIXER FAUCET
CARTUCHO CERÁMICA MONOMANDO BAÑO/DUCHA

3406901

SPARE PART OF / RECAMBIO DE
2480106, 2480107

AIR FILTER BASIN/BIDET MIXER
FILTRO AIREADOR MONOMANDO LAVABO/BIDÉ

3407000

CHROME / CROMO

SPARE PART OF / RECAMBIO DE
2480102, 2480103, 2480104

AIR FILTER BATH/SHOWER MIXER
FILTRO AIREADOR MONOMANDO BAÑO/DUCHA

3407001

CHROME / CROMO

SPARE PART OF / RECAMBIO DE
2480106, 2480107

MIXER FLEXIBLE LINKS
LATIGUILLOS MONOMANDO

3407100

SPARE PART OF / RECAMBIO DE
2480102, 2480103, 2480104

FLEXIBLE HOSE
FLEXO DUCHA

3410193

SPARE PART OF / RECAMBIO DE
2480106, 2480107

HANDSHOWER
TELEDUCHA

3410194

CHROME / CROMO

SPARE PART OF / RECAMBIO DE
2480106, 2480107



Flow

Design by **Azúa Moliné**





Features

Swivel tap.
Flow limiter: 8l/min.
Progressive flow and temperature.
Hidden aerator.

Características

Caño giratorio.
Limitador de caudal: 8l/min.
Caudal y temperatura progresivos.
Aireador oculto.

Organic forms that are elegantly combined with the most refined geometry.

Formas orgánicas que combinan de forma elegante con la geometría más depurada.

FINISHES / ACABADOS



01
CHROME
CROMO



05
GLOSSY WHITE
BLANCO BRILLO

65
MATE WHITE
BLANCO MATE



06
GLOSSY BLACK
NEGRO BRILLO

36
MATE BLACK
NEGRO MATE

Spare parts | Recambios



SINGLE LEVER BASIN MIXER FAUCET
GRIFO MONOMANDO LAVABO

254 01 01
CHROME / CROMO

254 05 01
GLOSSY WHITE / BLANCO BRILLO

254 65 01
MATTE WHITE / BLANCO MATE

254 06 01
GLOSSY BLACK / NEGRO BRILLO

254 36 01
MATTE BLACK / NEGRO MATE

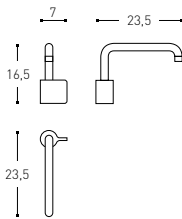

INCH 2.7x9.2x6.5

AIR FILTER FOR FAUCET / TAP
FILTRO AIREADOR GRIFO LAVABO

3410262

GLOSSY / BRILLO

SPARE PART OF / RECAMBIO DE
254AA01, 254AA02



SINGLE LEVER BASIN MIXER FAUCET
GRIFO MONOMANDO LAVABO

254 01 02
CHROME / CROMO

254 05 02
GLOSSY WHITE / BLANCO BRILLO

254 65 02
MATTE WHITE / BLANCO MATE

254 06 01
GLOSSY BLACK / NEGRO BRILLO

254 36 01
MATTE BLACK / NEGRO MATE

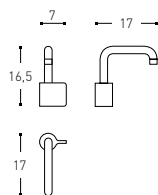

INCH 2.7x6.7x6.5







Lighting

Iluminación

296 **Light**



Light

Design by **Cosmic Studio**







Remote controlled applies with bi-LED technology, to regulate intensity and warmth.

Aplique con tecnología bi-LED, que incluye mando para regular la intensidad y calidez de la luz.

Conceived to illuminate bathroom atmospheres with the focus on the environment not the light source. Sober, subtle shapes that become one with the components.

Concebido para iluminar ambientes de baño resaltando el entorno y no la fuente de luz. Formas sobrias sin estridencias que se suman al conjunto de elementos.

FINISHES / ACABADOS

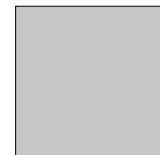

01
CHROME
CROMO

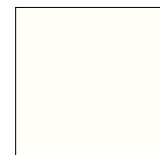

65
MATE WHITE
BLANCO MATE



36
MATE BLACK
NEGRO MATE

Spare parts | Recambios



●
BILED WALL LAMP REMOTE CONTROL
APLIQUE BILED CON MANDO A DISTANCIA

755 0190
(LED CII IP44 1X12W) (INPUT 110-220V)

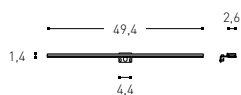

INCH 19.4x1x0.5

REMOTE CONTROL
MANDO A DISTANCIA

3410712
CHROME / CROMO

SPARE PART OF / RECAMBIO DE
7550190

WALL MOUNTING SET FOR MIRROR
ACCESORIO SUJECIÓN ESPEJO

3410713
SPARE PART OF / RECAMBIO DE
7550190



●
LED WALL LAMP
APLIQUE LED

- **768 01 90**
30 CM
- **768 65 90**
30 CM
- **768 36 90**
30 CM
- **768 01 91**
45 CM
- **768 65 91**
45 CM
- **768 36 91**
45 CM

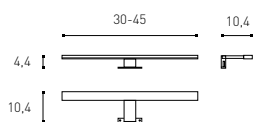

INCH 11.8-17.7x4.1x1.7





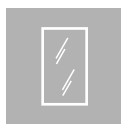

Mirrors

Espejos

- 302 **Basic**
 - 308 **Container**
 - 314 **Global Container**
 - 322 **Flow**
 - 328 **Led Lighting**
 - 334 **Modular**
 - 342 **The Grid**
-



Basic

Design by **Cosmic Studio**







Features

Lifetime durability / 10 year guarantee.
Optional anti-fog system. 480 h test in saline fog (anti-corrosion).

Características

Lifetime durability / garantía 10 años.
Sistema antivaho free fog system opcional.
Test de 480 h en niebla salina (anticorrosión).

Simplicity with maximum functionality.
A reappraisal of simple, pure lines for every environment.

La simplicidad que consigue la máxima funcionalidad. Reivindicación de líneas simples y puras para todo tipo de entornos.

FINISHES / ACABADOS

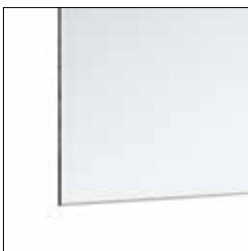

81
BISONET
BISONET



MIRROR
ESPEJO

- 281 81 40**
Ø 40 CM / INCH 15.7
- 281 81 41**
Ø 60 CM / INCH 23.6
- 281 81 42 (1)**
Ø 80 CM / INCH 31.5
- 281 81 43 (2)**
Ø 100 CM / INCH 39.4

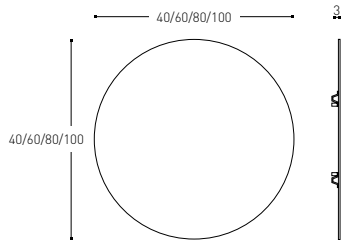

INCH Ø 15.7 / Ø 23.6 / Ø 31.5 / Ø 39.4



MIRROR
ESPEJO

- 281 81 33**
60 CM / INCH 23.6
- 281 81 44 (1)**
80 CM / INCH 31.5
- 281 81 45 (2)**
100 CM / INCH 39.4

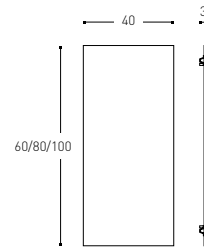

INCH 15.7x23.6/31.5/39.4



MIRROR
ESPEJO

- 281 81 46**
60 CM / INCH 23.6
- 281 81 35 (2)**
80 CM / INCH 31.5
- 281 81 47 (3)**
100 CM / INCH 39.4

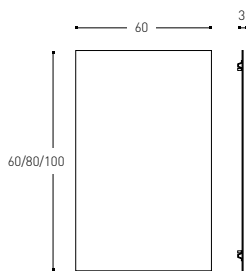

INCH 23.6x23.6/31.5/39.4



MIRROR
ESPEJO

- 281 81 48 (2)**
80 CM / INCH 31.5
- 281 81 49 (2)**
100 CM / INCH 39.4

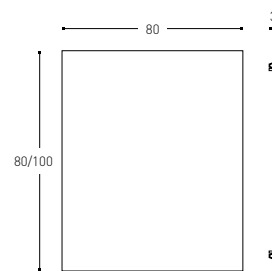

INCH 31.5x31.5/39.4

(1) WE RECOMMEND HEATING FOILS FOR MIRRORS
RECOMENDAMOS PLACA ANTIVAHO
REF. 290 00 31

(2) WE RECOMMEND HEATING FOILS FOR MIRRORS
RECOMENDAMOS PLACA ANTIVAHO
REF. 290 00 32

(3) WE RECOMMEND HEATING FOILS FOR MIRRORS
RECOMENDAMOS PLACA ANTIVAHO
REF. 290 00 33



Basic

Design by **Cosmic Studio**



◆
MIRROR
ESPEJO

281 81 50⁽⁴⁾
100 CM / INCH 39.4x39.4

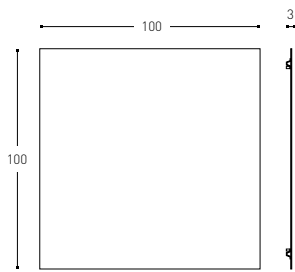

INCH 39.4x39.4

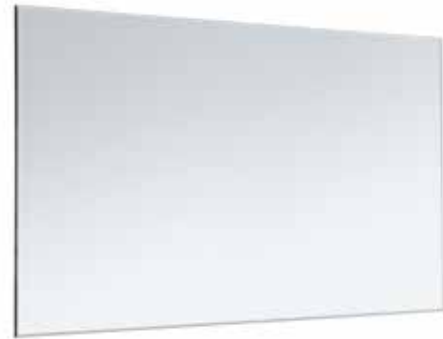

◆
MIRROR
ESPEJO

281 81 51⁽⁴⁾
60 CM / INCH 23.6
281 81 52⁽⁴⁾
80 CM / INCH 31.5
281 81 53⁽⁴⁾
100 CM / INCH 39.4

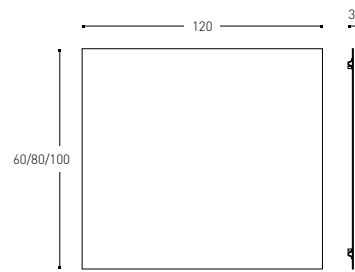

INCH 47.2x23.6/31.5/39.4

△
HEATING FOILS FOR MIRRORS
PLACA ANTIVAHO

290 00 31
30x45 CM / INCH 11.8x17.7
290 00 32
35x50 CM / INCH 13.8x19.7
290 00 33
50x50 CM / INCH 19.7x19.7
290 00 34
45x75 CM / INCH 17.7x29.5

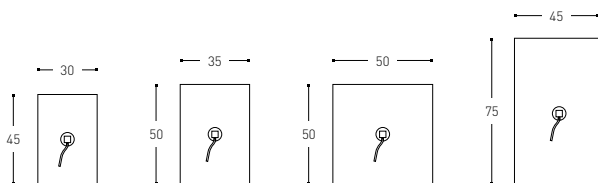

(4) WE RECOMMEND HEATING FOILS FOR MIRRORS
RECOMENDAMOS PLACA ANTIVAHO
REF. 290 00 34

Spare parts | Recambios

DRYWALL ANCHOR
TACO PLADUR

3410635

SPARE PART OF / RECAMBIO DE

2818133, 2818135, 2818140, 2818141, 2818142, 2818143, 2818144, 2818145,
2818146, 2818147, 2818148, 2818149, 2818150, 2818151, 2818152, 2818153

MIRROR MOUNTING SET
ACCESORIO SUJECIÓN ESPEJO

3309000

SPARE PART OF / RECAMBIO DE

2818133, 2818135, 2818140, 2818141, 2818142, 2818143, 2818144, 2818145,
2818146, 2818147, 2818148, 2818149, 2818150, 2818151, 2818152, 2818153



Container

Design by Claramunt De Mas







775 85 25
REVOLVING MIRROR + TOWEL RACK SHELF + HOOK
ESPEJO GIRATORIO + TOALLERO ESTANTE + COLGADOR
(57,5X37,6X198,6 CM)



775 85 23
REVOLVING MIRROR + 4 TOWEL RACKS SHELF
ESPEJO GIRATORIO + 4 TOALLEROS ESTANTE
(57,5X37,6X198,6 CM)





The revolving mirror measuring 1.90 m high, it allows for a full length view. The angle at which it turns means that shelving for box containers can be hidden from view behind it.

Espejo giratorio de 1,90 m, posibilita que una persona se refleje totalmente. El ángulo de giro permite esconder detrás de él estantes donde depositar cajas-container.



Special hook for bathrobes.

Colgador especial para albornoces.

CODE / CODIFICACIÓN

775 CC 23

COLLECTION
COLECCIÓN

FINISHES
ACABADOS

TYPE
MODELO

CC

FURNITURE / MUEBLES



80
ANCIENT OAK
ROBLE MILENARIO



85
CANADIAN OAK
ROBLE CANADIENSE



REVOLVING MIRROR + 4 TOWEL RACKS SHELF
ESPEJO GIRATORIO + 4 TOALLEROS ESTANTE

775 CC 23 *

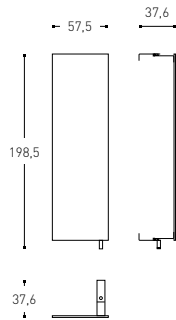

INCH 22.6x14.8x78.1

*1BIG BASKET AND 1SMALL BASKET INCLUDED
*1 CONTAINER GRANDE Y 1 CONTAINER PEQUEÑO INCLUIDOS



REVOLVING MIRROR + TOWEL RACK SHELF + HOOK
ESPEJO GIRATORIO + TOALLERO ESTANTE + COLGADOR

775 CC 25

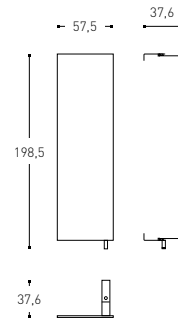

INCH 22.6x14.8x78.1

Spare parts | Recambios

MOUNTING SET
ACCESORIO SUJECIÓN

3410653

SPARE PART OF / RECAMBIO DE
7758023, 7758523, 7758025, 7758525



Global Container

Design by **Claramunt De Mas**

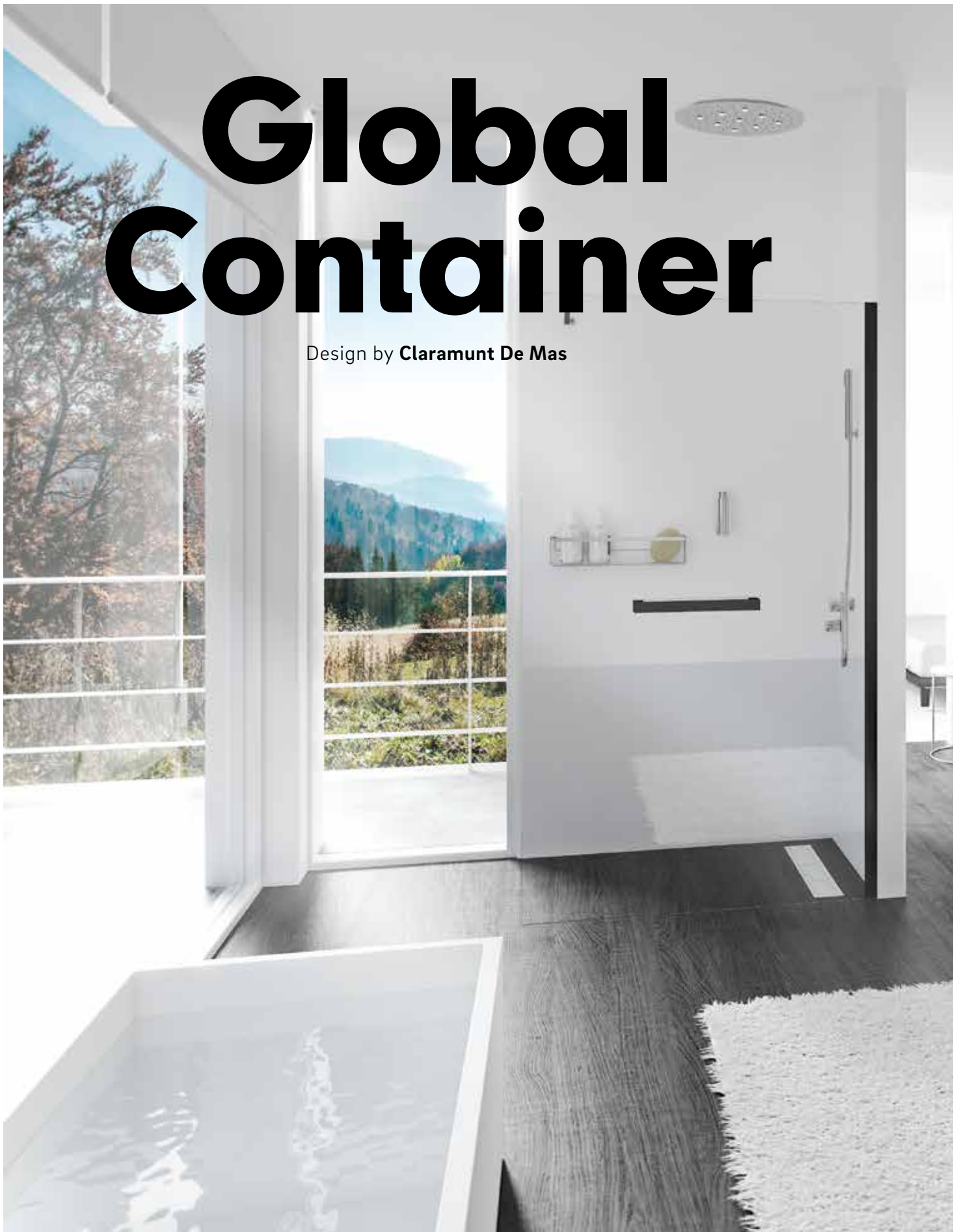





Simple lines and innovative concepts
reveal an ultra-contemporary collection.

Una colección ultra contemporánea
por sus líneas básicas y conceptos
innovadores.



755 45 03
SLIDING MIRROR
ESPEJO CORREDERO
(100X12,5X85 CM)



Global Container

Design by **Claramunt De Mas**



Shelving and mirror have combined together in this collection to become a "wall-less" dressing room with a mirror which slides through the shelves, hiding or revealing the items inside.

Estantes y espejo se han fusionado en esta colección convirtiéndose en un armario camerino sin "paredes" en el que el espejo desliza por los estantes ocultando o dejando al descubierto los objetos de uso diario.

Remote controlled applies with bi-LED technology, to regulate intensity and warmth.

Aplique con tecnología bi-LED, que incluye mando para regular la intensidad y calidez de la luz.



CODE / CODIFICACIÓN

755 DD 01

WHITE / MATTE INOX / GLOSSY SILVER
BLANCO / INOX MATE / PLATA BRILLO

COLLECTION
COLECCIÓN

FINISHES
ACABADOS

TYPE
MODELO

SHELVES AND MIRRORS / ESTANTES Y ESPEJOS

DD



45
WHITE
BLANCO

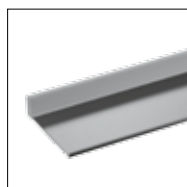

59
MATTE INOX
INOX MATE



89
GLOSSY SILVER
PLATA BRILLO



◆ ●
MIRROR
ESPEJO

755 DD 01 *

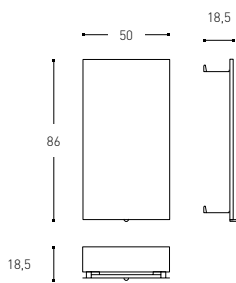

INCH 19.7x7.3x33.9



◆ ●
SLIDING MIRROR
ESPEJO CORREDERO

755 DD 02 *

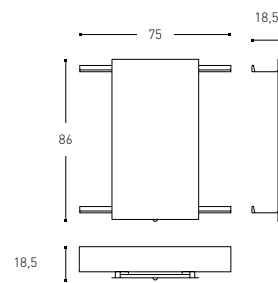

INCH 29.5x7.3x33.9



◆ ●
SLIDING MIRROR
ESPEJO CORREDERO

755 DD 03 *

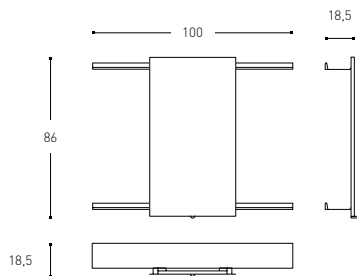

INCH 39.4x7.3x33.9



●
SHELF (X2)
ESTANTE (X2)

755 DD 47
50 CM

755 DD 44
75 CM

755 DD 50
100 CM

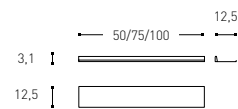

INCH 2.9x4.9x1.2

* INCLUDES 1 CONTAINER AND 1 TALL CONTAINER
* INCLUYE 1 CONTAINER Y 1 CONTAINER ALTO



Global Container

Design by **Claramunt De Mas**

SPARE PART OF / RECAMBIO DE
DRYWALL ANCHOR
TACO PLADUR

3410637

SPARE PART OF / RECAMBIO DE
7555901, 7554501, 7554502, 7554503, 7555902, 7555903, 7558901, 7558902,
7558903

STOPPER SET
CONJUNTO TOPE

3410654

SPARE PART OF / RECAMBIO DE
7555901, 7554501, 7554502, 7554503, 7555902, 7555903, 7558901, 7558902,
7558903

GLASS CLIP SET
CONJUNTO 2 CLIPS

3410655

SPARE PART OF / RECAMBIO DE
7555901, 7554501, 7554502, 7554503, 7555902, 7555903, 7558901, 7558902,
7558903

MIRROR DOOR HANDLE
TIRADOR PUERTA ESPEJO

3410656

SPARE PART OF / RECAMBIO DE
7555901, 7554501, 7554502, 7554503, 7555902, 7555903, 7558901, 7558902,
7558903



Flow

Design by **Azúa Moliné**







Features

Lifetime durability / 10 year guarantee.
Optional anti-fog system. 480 h test in saline fog (anti-corrosion).

Características

Lifetime durability / garantía 10 años.
Sistema antivaho free fog system opcional.
Test de 480 h en niebla salina (anticorrosión).

Movement enables the position to be adjusted and give the bathroom space another perspective.

El movimiento permite ajustar la orientación y dar una nueva perspectiva del espacio del baño.

FINISHES / ACABADOS



86
BISONET
BISONET



TILTING MIRROR
ESPEJO BASCULANTE

281 86 01

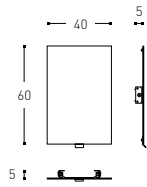

INCH 15.7x23.6



TILTING MIRROR
ESPEJO BASCULANTE

281 86 00

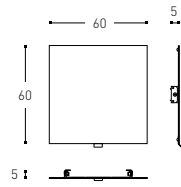

INCH 23.6x23.6



TILTING MIRROR
ESPEJO BASCULANTE

281 86 02⁽¹⁾

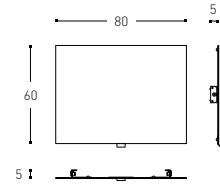

INCH 31.5x23.6



TILTING MIRROR
ESPEJO BASCULANTE

281 86 03⁽²⁾

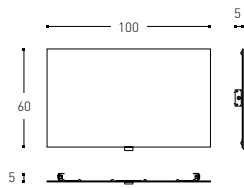

INCH 39.4x23.6

HEATING FOILS FOR MIRRORS
PLACA ANTIVAHÓ

290 00 32
35x50 CM / INCH 13.8x19.7
290 00 33
50x50 CM / INCH 19.7x19.7

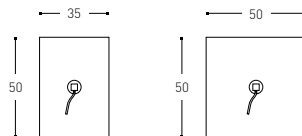

(1) WE RECOMMEND HEATING FOILS FOR MIRRORS
RECOMENDAMOS PLACA ANTIVAHÓ
REF. 290 00 32

(2) WE RECOMMEND HEATING FOILS FOR MIRRORS
RECOMENDAMOS PLACA ANTIVAHÓ
REF. 290 00 33



SPARE PART / RECAMBIO DE
DRYWALL ANCHOR
TACO PLADUR

3410637

SPARE PART OF / RECAMBIO DE
2818600, 2818601, 2818602, 2818603

MIRROR MOUNTING SET
ACCESORIO SUJECIÓN ESPEJO

3309000

SPARE PART OF / RECAMBIO DE
2818600, 2818601, 2818602, 2818603

3308100

SPARE PART OF / RECAMBIO DE
2818600, 2818601, 2818602, 2818603



Led Lighting

Design by **Cosmic Studio**





Led Lighting

Design by Cosmic Studio



New generation of mirrors with built-in LED light.

Nueva generación de espejos con luz LED incorporada.

Mirrors with LED lighting on one of the sides (reversible) or with double lighting, depending on the measures of width. (12W – IP44).

Espejos con iluminación LED en uno de los laterales (reversibles) o con doble iluminación, dependiendo de las medidas de ancho. (12W – IP44).

LED temperature 4000K
A+ Energy efficiency
IP44

Temperatura de color de los LED 4000K
Eficiencia energética del espejo A+
IP44

Heating foils in the mirrors with dual illumination activated by a separate switch.

Sistema antivaho en los espejos de doble iluminación, que se activa con un interruptor independiente.

Hidden power-light switch.

Interruptor de encendido y apagado de luz oculto.



Led Lighting has successfully passed the high demanding tests of long last durability and resistance to extreme uses (static charge or impact testing) to assure long last durability of the product.

Toda la gama **Led Lighting** ha superado con éxito exigentes tests de durabilidad y resistencia a usos extremos (cargas estáticas o test de impacto), para asegurar una larga vida al producto.





LATERAL LED LIGHT MIRROR
ESPEJO CON ILUMINACIÓN LED LATERAL

28182 01

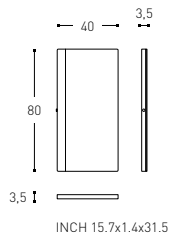

LATERAL LED LIGHT MIRROR
ESPEJO CON ILUMINACIÓN LED LATERAL

28182 02

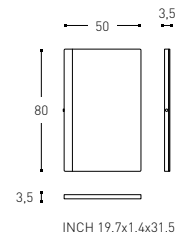

LATERAL LED LIGHT MIRROR
ESPEJO CON ILUMINACIÓN LED LATERAL

28182 03

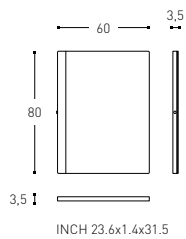

DOUBLE LATERAL LED LIGHT MIRROR W/LOWER LED LIGHT
ESPEJO CON DOBLE ILUMINACIÓN LED LATERAL Y LED INFERIOR

28182 04

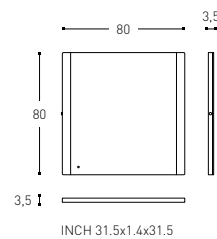

WITH HEATING FOIL FOR MIRROR
CON PLACA ANTIVAHÓ



Led Lighting

Design by **Cosmic Studio**



◆
DOUBLE LATERAL LED LIGHT MIRROR W/LOWER LED LIGHT
ESPEJO CON DOBLE ILUMINACIÓN LED LATERAL Y LED INFERIOR

28182 05

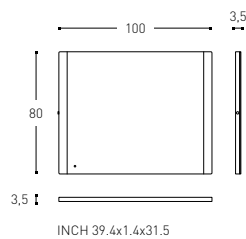

WITH HEATING FOIL FOR MIRROR
CON PLACA ANTIVAHO



◆
DOUBLE LATERAL LED LIGHT MIRROR W/LOWER LED LIGHT
ESPEJO CON DOBLE ILUMINACIÓN LED LATERAL Y LED INFERIOR

28182 06

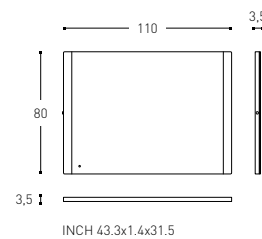

WITH HEATING FOIL FOR MIRROR
CON PLACA ANTIVAHO

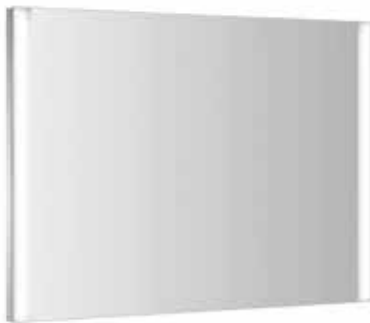

◆
DOUBLE LATERAL LED LIGHT MIRROR W/LOWER LED LIGHT
ESPEJO CON DOBLE ILUMINACIÓN LED LATERAL Y LED INFERIOR

28182 07

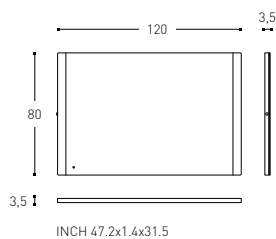

WITH HEATING FOIL FOR MIRROR
CON PLACA ANTIVAHO

Spare parts | Recambios

MIRROR MOUNTING SET
ACCESORIO SUJECIÓN ESPEJO

3410716

SPARE PART OF / RECAMBIO DE
2818201, 2818202, 2818203, 2818204, 2818205, 2818206, 2818207

POWER SUPPLY
FUENTE DE ALIMENTACIÓN

3410717

SPARE PART OF / RECAMBIO DE
2818201, 2818202, 2818203, 2818204, 2818205, 2818206, 2818207



Modular

Design by Àlex Armenter

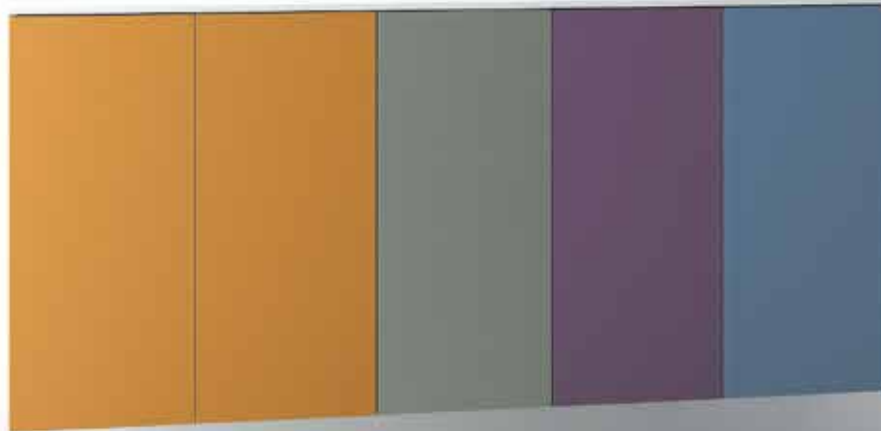





Mirror Cabinets with or without a light and a socket. Built in bottom handle. Inside shelves made of adjustable glass.

Armarios espejo con y sin luz y enchufe. Tirador inferior integrado. Estantes interiores de vidrio regulables.



Available in three different widths. Cabinets with a width of 40 or 50 cm fitted with a 24w light. Cabinets with a width of 60 cm fitted with a 40 w light. PVC or lacquered matte finish.

Disponibles en tres medidas de ancho. Los de 40 y 50 cm con luz tienen potencia de 24 w. Los de 60 cm con luz, tienen 40 w de potencia. Acabados en PVC o lacado mate.

Medicine cabinets | Armarios espejo

CODE / CODIFICACIÓN

744 **AAA** 000 00 08 A 04

PVC STRUCTURE
CUERPO PVC

744 **BBB** 000 00 08 A 04

MATTE STRUCTURE
CUERPO MATE

COLLECTION
COLECCIÓN

STRUCTURE COLOUR
COLOR CUERPO

TYPE
MODELO

FINISHES / ACABADOS

AAA

PVC

STRUCTURE COLOUR
COLOR CUERPO



129
MATTE WHITE
BLANCO MATE



130
MATE ANTHRACITE
ANTRACITA MATE

BBB

MATTE LACQUERED / LACADO MATE

STRUCTURE COLOUR
COLOR CUERPO



102
MATE WHITE
BLANCO MATE



104
MATTE LIGHT GREY
GRIS CLARO MATE



110
MATTE LIGHT CREAM
CREMA LIGHT MATE



140
MATTE OLIVE GREY
GRIS OLIVA MATE



112
MATTE MINK
VISÓN MATE



106
MATTE AMETHYST
GREY
GRIS AMATISTA MATE



114
MATTE CHOCOLATE
CHOCOLATE MATE



108
MATTE BLACK
NEGRO MATE



116
MATTE GREEN
VERDE MATE



126
MATTE BLUE
AZUL MATE



124
MATTE AUBERGINE
BERENJENA MATE



122
MATTE PINK
ROSA MATE



120
MATTE RUBY
RUBÍ MATE



118
MATTE ORANGE
NARANJA MATE



128
MATTE METALLIC GREY
GRIS METALIZADO
MATE



Modular

Design by Àlex Armenter



◆ ■ □
MEDICINE CABINET
 ARMARIO ESPEJO
 40 CM / INCH 15.7

- ☞ **744 AAA 000 00 06 A 04**
PVC / PVC
- ☞ **744 AAA 000 00 06 A 02**
PVC / PVC
- ☞ **744 BBB 000 00 06 A 04**
MATTE LACQUERED / LACADO MATE
- ☞ **744 BBB 000 00 06 A 02**
MATTE LACQUERED / LACADO MATE

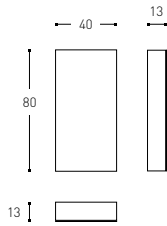

INCH 15.7x5.1x31.5



◆ ■ □
MEDICINE CABINET
 ARMARIO ESPEJO
 50 CM / INCH 19.7

- ☞ **744 AAA 000 00 08 A 04**
PVC / PVC
- ☞ **744 AAA 000 00 08 A 02**
PVC / PVC
- ☞ **744 BBB 000 00 08 A 04**
MATTE LACQUERED / LACADO MATE
- ☞ **744 BBB 000 00 08 A 02**
MATTE LACQUERED / LACADO MATE

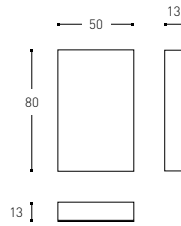

INCH 19.7x5.1x31.5



◆ ■ □
MEDICINE CABINET
 ARMARIO ESPEJO
 60 CM / INCH 23.6

- ☞ **744 AAA 000 00 10 A 04**
PVC / PVC
- ☞ **744 AAA 000 00 10 A 02**
PVC / PVC
- ☞ **744 BBB 000 00 10 A 04**
MATTE LACQUERED / LACADO MATE
- ☞ **744 BBB 000 00 10 A 02**
MATTE LACQUERED / LACADO MATE

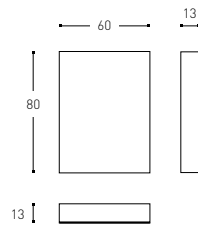

INCH 23.6x5.1x31.5



◆ ■ □
MEDICINE CABINET WITH LIGHTING
 ARMARIO ESPEJO CON LUZ
 40 CM / INCH 15.7
 [1XTC-L 24W IP44 CE]

- ☞ **744 AAA 000 00 06 A 06**
PVC / PVC
- ☞ **744 AAA 000 00 06 A 05**
PVC / PVC
- ☞ **744 BBB 000 00 06 A 06**
MATTE LACQUERED / LACADO MATE
- ☞ **744 BBB 000 00 06 A 05**
MATTE LACQUERED / LACADO MATE

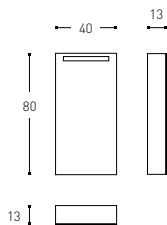

INCH 15.7x5.1x31.5



◆ ■ □
MEDICINE CABINET WITH LIGHTING
 ARMARIO ESPEJO CON LUZ
 50 CM / INCH 19.7
 [1XTC-L 24W IP44 CE]

- ☞ **744 AAA 000 00 08 A 06**
PVC / PVC
- ☞ **744 AAA 000 00 08 A 05**
PVC / PVC
- ☞ **744 BBB 000 00 08 A 06**
MATTE LACQUERED / LACADO MATE
- ☞ **744 BBB 000 00 08 A 05**
MATTE LACQUERED / LACADO MATE

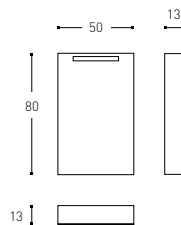

INCH 19.7x5.1x31.5



◆ ■ □
MEDICINE CABINET WITH LIGHTING
 ARMARIO ESPEJO CON LUZ
 60 CM / INCH 23.6
 [1XTC-L 24W IP44 CE]

- ☞ **744 AAA 000 00 10 A 06**
PVC / PVC
- ☞ **744 AAA 000 00 10 A 05**
PVC / PVC
- ☞ **744 BBB 000 00 10 A 06**
MATTE LACQUERED / LACADO MATE
- ☞ **744 BBB 000 00 10 A 05**
MATTE LACQUERED / LACADO MATE

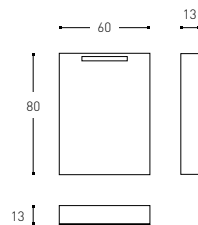

INCH 23.6x5.1x31.5



MEDICINE CABINET WITH LIGHTING & SOCKET
 ARMARIO ESPEJO CON LUZ Y ENCHUFE

40 CM / INCH 15.7
 [1XTC-L 24W IP44 CE]

- 744 AAA 000 00 06 A 03**
PVC / PVC
- 744 AAA 000 00 06 A 01**
PVC / PVC
- 744 BBB 000 00 06 A 03**
MATTE LACQUERED / LACADO MATE
- 744 BBB 000 00 06 A 01**
MATTE LACQUERED / LACADO MATE

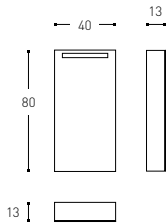

INCH 15.7x5.1x31.5



MEDICINE CABINET WITH LIGHTING & SOCKET
 ARMARIO ESPEJO CON LUZ Y ENCHUFE

50 CM / INCH 19.7
 [1XTC-L 24W IP44 CE]

- 744 AAA 000 00 08 A 03**
PVC / PVC
- 744 AAA 000 00 08 A 01**
PVC / PVC
- 744 BBB 000 00 08 A 03**
MATTE LACQUERED / LACADO MATE
- 744 BBB 000 00 08 A 01**
MATTE LACQUERED / LACADO MATE

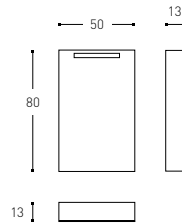

INCH 19.7x5.1x31.5



MEDICINE CABINET WITH LIGHTING & SOCKET
 ARMARIO ESPEJO CON LUZ Y ENCHUFE

60 CM / INCH 23.6
 [1XTC-L 24W IP44 CE]

- 744 AAA 000 00 10 A 03**
PVC / PVC
- 744 AAA 000 00 10 A 01**
PVC / PVC
- 744 BBB 000 00 10 A 03**
MATTE LACQUERED / LACADO MATE
- 744 BBB 000 00 10 A 01**
MATTE LACQUERED / LACADO MATE

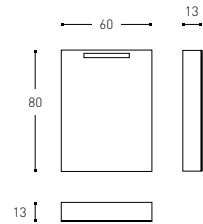

INCH 23.6x5.1x31.5



Modular

Design by Àlex Armenter

CABINET HINGE
BISAGRA MUEBLE

34191 08

SPARE PART OF / RECAMBIO DE
MEDICINE CABINETS
ARMARIOS ESPEJO

MIRROR DOOR
PUERTA ESPEJO

(RIGHT / DERECHA)

34190 36
40 CM / INCH 15.7

34190 37
50 CM / INCH 19.7

34190 38
60 CM / INCH 23.6

SPARE PART OF / RECAMBIO DE
RIGHT HANDSIDE MEDICINE CABINETS
ARMARIOS ESPEJO DERECHA

(LEFT / IZQUIERDA)

34194 11
40 CM / INCH 15.7

34194 12
50 CM / INCH 19.7

34194 13
60 CM / INCH 23.6

SPARE PART OF / RECAMBIO DE
LEFT HANDSIDE MEDICINE CABINETS
ARMARIOS ESPEJO IZQUIERDA

MIRROR DOOR FOR LIGHT
PUERTA ESPEJO PARA LUZ

(RIGHT / DERECHA)

34190 39
40 CM / INCH 15.7

34190 40
50 CM / INCH 19.7

34190 41
60 CM / INCH 23.6

SPARE PART OF / RECAMBIO DE
RIGHT HANDSIDE MEDICINE CABINETS WITH LIGHTING
ARMARIOS ESPEJO DERECHA CON LUZ

(LEFT / IZQUIERDA)

34190 42
40 CM / INCH 15.7

34190 43
50 CM / INCH 19.7

34190 44
60 CM / INCH 23.6

SPARE PART OF / RECAMBIO DE
LEFT HANDSIDE MEDICINE CABINETS WITH LIGHTING
ARMARIOS ESPEJO IZQUIERDA CON LUZ

GLASS FLAT SHELF
ESTANTE CRISTAL

34190 33
40 CM / INCH 15.7

34190 34
50 CM / INCH 19.7

34190 35
60 CM / INCH 23.6

SPARE PART OF / RECAMBIO DE
MEDICINE CABINETS
ARMARIOS ESPEJO

FLUORESCENT TUBE
TUBO FLUORESCENTE

34190 27
40-50 CM / INCH 15.7-19.7

34190 28
60 CM / INCH 23.6

SPARE PART OF / RECAMBIO DE
MEDICINE CABINETS WITH LIGHTING
ARMARIOS ESPEJO CON LUZ

DIFFUSER
DIFUSOR

34190 29
40 CM / 15.7 INCH

34190 30
50 CM / 19.7 INCH

34190 31
60 CM / 23.6 INCH

SPARE PART OF / RECAMBIO DE
MEDICINE CABINETS WITH LIGHTING
ARMARIOS ESPEJO CON LUZ

SOCKET
ENCHUFE

34190 32

SPARE PART OF / RECAMBIO DE
MEDICINE CABINETS WITH LIGHTING&SOCKET
ARMARIOS ESPEJO CON LUZ Y ENCHUFE



The Grid

Design by **Ricard Ferrer**





The Grid

Design by Ricard Ferrer



Mirror cabinets with fumed glass shelves.

Armarios espejo con estantes en cristal fumé.



Eco friendly: furniture made in Spain with certified wood board (PEFC/FSC) following the chain of custody in forestry. Lacquered finishing and high quality laminate. Colours unalterable over time.

Producto ambientalmente responsable: muebles fabricados en España con tableros de madera certificada (PEFC/FSC) conforme la cadena de custodia de productos forestales. Acabados lacados y chapados de alta gama. Los tonos se mantienen inalterables a lo largo del tiempo.

Parallel lines which frame objects specifically designed for an architecturally engineered bathroom.

Líneas paralelas que enmarcan objetos dedicados a un baño concebido desde la óptica arquitectónica.





2
YEARS GUARANTEE
AÑOS GARANTÍA
COSMIC

The Grid range has successfully passed the high demanding tests of long last durability and resistance to extreme uses (static charge or impact testing) to assure long last durability of the product.

Toda la gama The Grid ha superado con éxito exigentes tests de durabilidad y resistencia a usos extremos (cargas estáticas o test de impacto), para asegurar una larga vida al producto.

FINISHES / ACABADOS

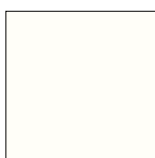

102
MATE WHITE
 BLANCO MATE

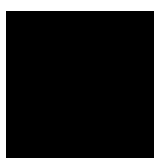

108
MATTE BLACK
 NEGRO MATE



194
CLEAR OAK
 ROBLE CLARO

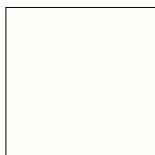

064
GLOSSY WHITE
 BLANCO BRILLO

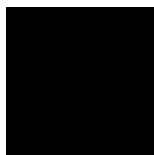

034
GLOSSY BLACK
 NEGRO BRILLO



195
DARK OAK
 ROBLE OSCURO



The Grid

Design by Ricard Ferrer



◆ ◻ ■
MEDICINE CABINET
 ARMARIO ESPEJO
 35 CM

- ◻ **768 00 05 05 102**
- ◻ **768 00 05 05 064**
- **768 00 05 05 108**
- **768 00 05 05 034**
- **768 00 05 05 194**
- **768 00 05 05 195**

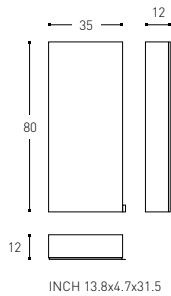

◆ ◻ ■
MEDICINE CABINET
 ARMARIO ESPEJO
 55 CM

- ◻ **768 00 09 05 102**
- ◻ **768 00 09 05 064**
- **768 00 09 05 108**
- **768 00 09 05 034**
- **768 00 09 05 194**
- **768 00 09 05 195**

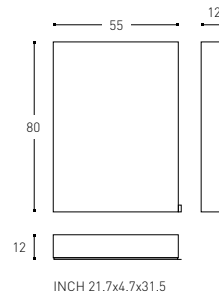

Spare parts | Recambios

CABINET MOUNTING SET
ACCESORIO SUJECIÓN ARMARIO

3419450

SPARE PART OF / RECAMBIO DE
768000505AAA, 768000905AAA

CABINET HINGE
BISAGRA MUEBLE/ARMARIO

3419108

SPARE PART OF / RECAMBIO DE
768000505BBB, 768000905BBB

HINGE BRAKE
FRENOS BISAGRAS

3419445

SPARE PART OF / RECAMBIO DE
768000505AAA, 768000905AAA

GLASS SHELF
ESTANTE VIDRIO

3419446

SPARE PART OF / RECAMBIO DE
768000505AAA

3419447

SPARE PART OF / RECAMBIO DE
768000905AAA

MIRROR DOOR
PUERTA ESPEJO

3419448

SPARE PART OF / RECAMBIO DE
768000505AAA

3419449

SPARE PART OF / RECAMBIO DE
768000905AAA







Accessories

Accesorios

350	Architect
368	Bath Life
380	Black & White
390	Container
400	Contract
410	Extreme
420	Logic
432	Minimalism
444	Project
456	The Grid
468	Working



Architect

Design by **Cosmic Studio**





A multitude of pieces come out of architectonic forms that dominate with their resistance. A comprehensive collection of accessories with a timeless and elegant design.

De las formas arquitectónicas surgen multitud de piezas que destacan por su resistencia. Colección completa con un diseño atemporal y elegante.

290 07 03
WASTE BIN
PAPELERA
(20,5X20,5X28)

205 01 96
VERTICAL PAPER HOLDER
PORTAPAPEL VERTICAL
(5,7X9X16,7)

205 01 72
TOWEL RING
TOALLERO ARO
(22,5X8,5X16)



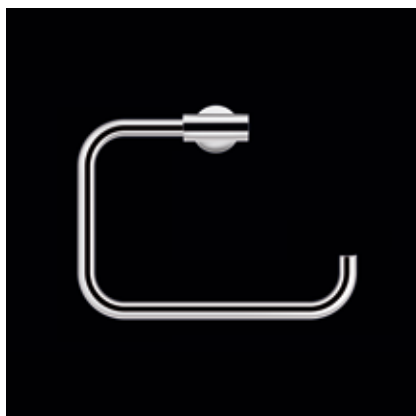
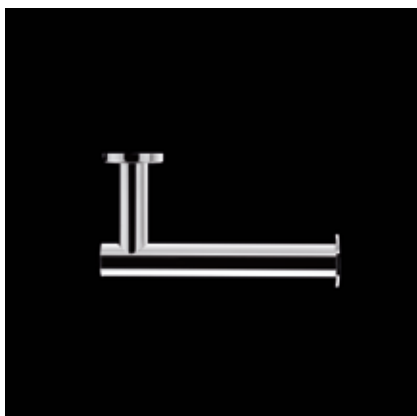

DUAL SYSTEM / SISTEMA DUAL

Our updated Architect collection now includes a dual installation system for installing bathroom accessories with or without a drill. Smart-fix adhesive, designed exclusively for our firm, means that bathroom accessories can be installed without drilling holes in the wall.

La colección Architect presenta como novedad el sistema de instalación dual, que permite sujetar los accesorios de baño con y sin taladros. Con el adhesivo Smart-fix, elaborado en exclusiva para la firma, se facilita el montaje sin la necesidad de hacer agujeros en la pared.

FEATURES / CARACTERÍSTICAS

Easy installation: double pitch screw. Hidden attachments. Anti-corrosion.

Fácil instalación: tornillo de doble paso. Fijaciones ocultas. Anticorrosión.

Architect has successfully passed the high demanding tests of long last durability and resistance to extreme uses (static charge or impact testing) to assure long last durability of the product.

Toda la gama Architect ha superado con éxito exigentes tests de durabilidad y resistencia a usos extremos (cargas estáticas o test de impacto), para asegurar una larga vida al producto.

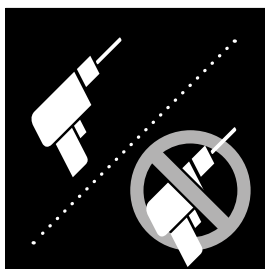

DUAL SYSTEM

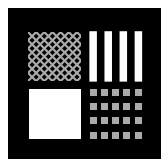

Works with different surfaces*

Efectivo en diferentes superficies*



Static load of 15 kg

Carga estática de 15 KG



Impact resistance

Resistente a impactos

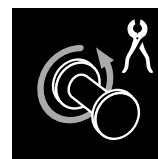

Removable accessories

Accesorios removibles



Quick, easy, silent installation

Montaje sin ruido, fácil y rápido

* Ceramic, porcelain, glazed surfaces, compact marble, even surfaces with roughness up to 0.5 mm thickness.

* Cerámica, porcelana, materiales vitrificados o mármoles compactos, e incluso superficies con una rugosidad de hasta 0,5 milímetros de espesor.

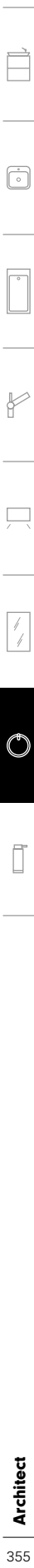



⊙
HOOK
 COLGADOR

205 0121

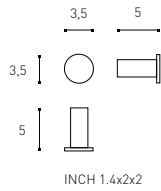

⊙
HOOK (2 U.)
 COLGADOR (2 U.)

205 0121D

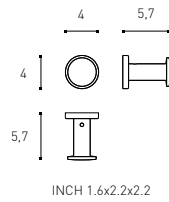

⊙⊙
DOUBLE HOOK
 COLGADOR DOBLE

205 0122

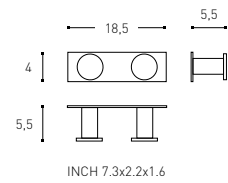

⊙
GLOVE HOOK
 PORTAGUANTES

205 0120

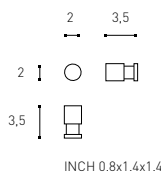

⊙⊙
SOAP DISH
 JABONERA

205 0132
205 0132D

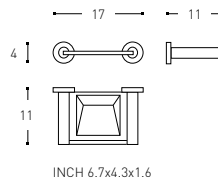

⊙⊙
SOAP DISH FOR BATHTUBE
 JABONERA BAÑERA

205 0133
205 0133D

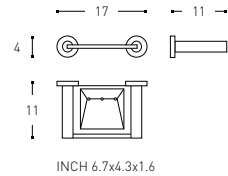



○
RACK SOAP DISH
JABONERA REJILLA

290 02 39

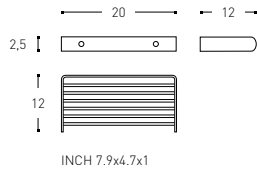

○
CORNER RACK SOAP DISH
JABONERA REJILLA RINCÓN

290 02 30

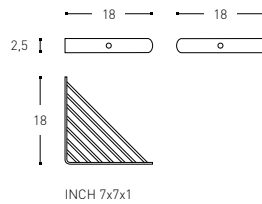

⊙ ⊙ ⊙
GLASS HOLDER
PORTAVASO

205 01 52
205 01 52D

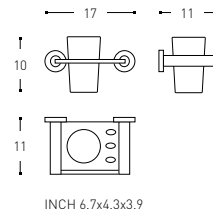

○△
FREE STANDING BRUSH-HOLDER
PORTACEPILLOS ENCIMERA

205 01 51

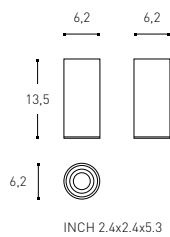

○△
BRUSH-HOLDER
PORTACEPILLOS

205 01 53
205 01 53D

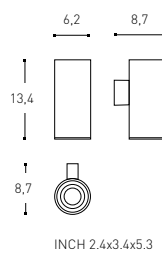

⊙
FREE STANDING SOAP DISPENSER
DOSIFICADOR ENCIMERA

205 01 04

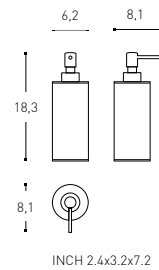



⊙
SOAP DISPENSER
DOSIFICADOR

205 01 03
205 0103D

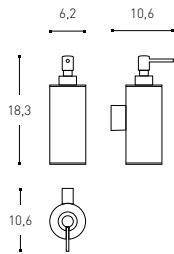

INCH 2.4x4.2x7.2



○
SOAP DISPENSER
DOSIFICADOR

290 02 25
1,50 L

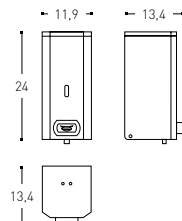

INCH 4.7x9.4x5.3



⊙△◇
WALL MAGNIFYING MIRROR WITH LIGHT
ESPEJO AUMENTO PARED CON LUZ

205 01 83

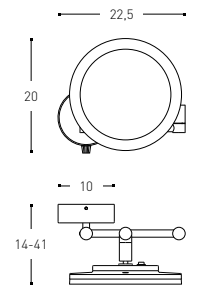

INCH 8.8(3.9)x5.5-16.1x7.9



⊙△◇
WALL MAGNIFYING MIRROR
ESPEJO DE AUMENTO PARED

205 01 84

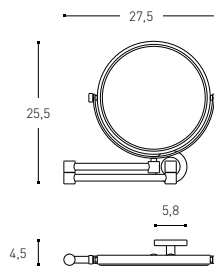

INCH 10.8(2.3)x1.8x10



○
TISSUE BOX
CAJA KLEENEX

290 02 20

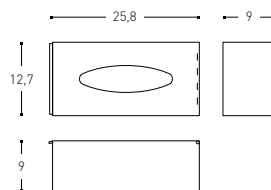

INCH 10.1x3.5x5



○
TOILET TISSUE DISPENSER
DISPENSADOR PAPEL TOALLA

290 02 27

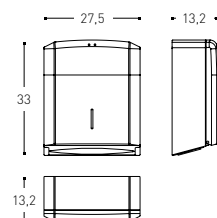

INCH 10.8x5.2x13



△
HAIRDRYER
SECADOR DE PELO

290 00 03

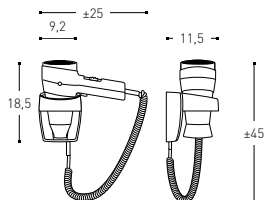

INCH $\pm 9.8 \times 4.5 \times 17.7$



◇◆
GLASS SHELF
ESTANTE VIDRIO

205 01 44
43 CM / INCH 16.9
205 01 44D
43 CM / INCH 16.9
205 01 45
60 CM / INCH 23.6
205 01 45D
60 CM / INCH 23.6

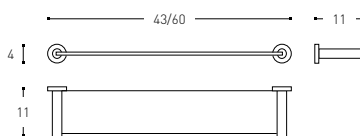

INCH 16.9/23.6x4.3x1.6



◎○
SHELF
ESTANTE

205 01 46
205 01 46D

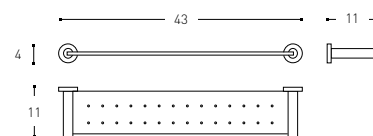

INCH 16.9x4.3x1.6



◎
TOWEL RACK
TOALLERO

205 01 67
205 01 67D

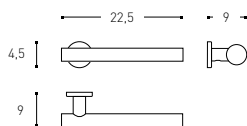

INCH 8.8x3.5x1.8



◎
TOWEL RACK
TOALLERO

205 01 64
41.5 CM / INCH 16.3
205 01 64D
41.5 CM / INCH 16.3
205 01 65
59 CM / INCH 23.2
205 01 65D
59 CM / INCH 23.2
205 01 66
78 CM / INCH 30.7
205 01 66D
78 CM / INCH 30.7

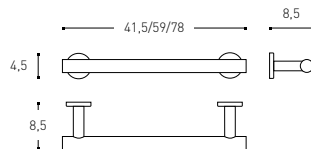

INCH 16.3/23.2/30.7x3.3x1.8



◎
DOUBLE TOWEL RACK
TOALLERO DOBLE

205 01 61
205 01 61D

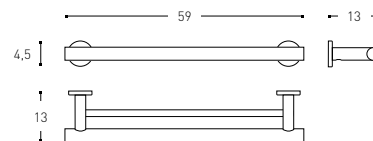

INCH 23.2x5.1x1.8





⊙
SWIVEL DOUBLE TOWEL RACK
 TOALLERO GIRATORIO DOBLE

240 0175

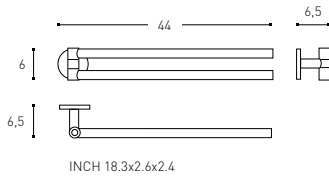

⊙
TOWEL RACK
 TOALLERO

205 0169

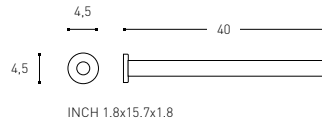

⊙
TOWEL RING
 TOALLERO ARO

205 0171
 12 CM / INCH 4.7
205 0171D
 12 CM / INCH 4.7
205 0172
 16 CM / INCH 6.3
205 0172D
 16 CM / INCH 6.3

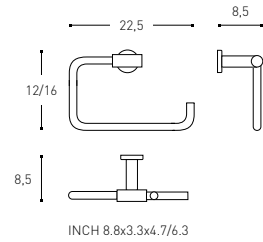

⊙
SHELF TOWEL RACK
 TOALLERO ESTANTE

205 0168
205 0168D

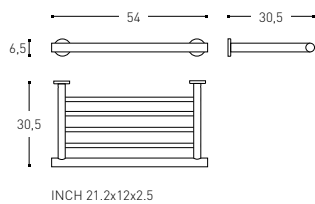

⊙
SHELF TOWEL RACK
 TOALLERO ESTANTE

290 0168
290 0168D

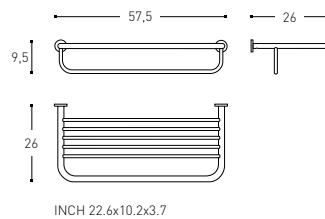

⊙
GRAB BAR
 ASA BAÑERA

290 02 10
 30 CM / INCH 11.8
290 02 11
 45 CM / INCH 17.7
290 02 12
 60 CM / INCH 23.6

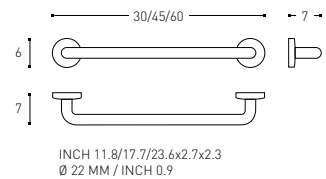



⊙
BATH GRAB BAR 135°
 ASA BAÑERA 135°

— **290 02 13**
 RIGHT / DERECHA
 — **290 02 14**
 LEFT / IZQUIERDA

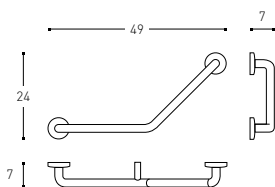

INCH 19.3x2.7x9.4
 Ø 22 MM / INCH 0.9



⊙
BATH GRAB BAR 90°
 ASA BAÑERA 90°

— **290 02 15**
 RIGHT / DERECHA
 — **290 02 16**
 LEFT / IZQUIERDA

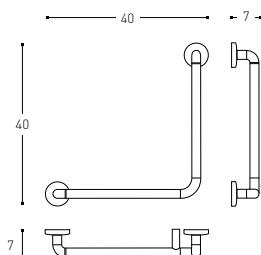

INCH 15.7x2.7x15.7
 Ø 22 MM / INCH 0.9



⊙
GRAB BAR/RIGHT SOAP DISH
 ASA BAÑERA/REJILLA DERECHA

290 01 26

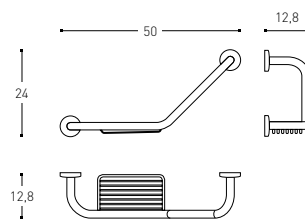

INCH 19.7x5x9.4
 Ø 22 MM / INCH 0.9



⊙
HINGED GRAB BAR
 ASA ABATIBLE

290 02 17

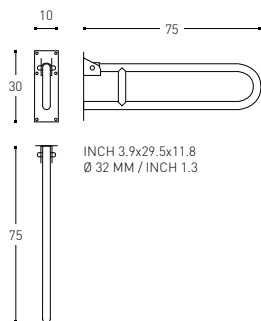

INCH 3.9x29.5x11.8
 Ø 32 MM / INCH 1.3



⊙
HINGED GRAB BAR WITH PAPER HOLDER
 ASA ABATIBLE CON PORTARROLLOS

290 02 18

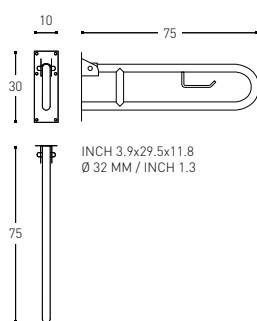

INCH 3.9x29.5x11.8
 Ø 32 MM / INCH 1.3



⊙△
PAPER HOLDER WITH COVER
 PORTAPAPEL CON TAPA

205 01 59

205 01 59D
 3M ADHESIVE MOUNTING SYSTEM
 SISTEMA FIJACION ADHESIVO 3M

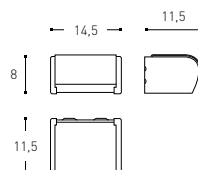

INCH 5.7x4.5x3.1





⊙
VERTICAL PAPER HOLDER
PORTAPEPEL VERTICAL

205 0196
205 0196D

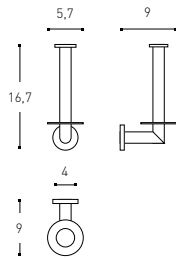

INCH 2.2x3.5x6.6



⊙
PAPER HOLDER WITHOUT COVER
PORTAPEPEL SIN TAPA

205 0158
205 0158D

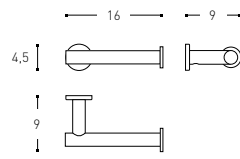

INCH 6.3x3.5x1.8



⊙
DOUBLE PAPER HOLDER WITHOUT COVER
PORTAPEPEL DOBLE SIN TAPA

205 0157
205 0157D

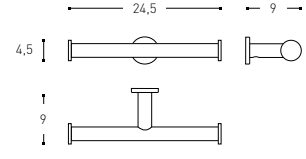

INCH 9.6x3.5x1.8



○
TOILET PAPER DISPENSER
DISPENSADOR PAPEL HIGIENICO

290 0226

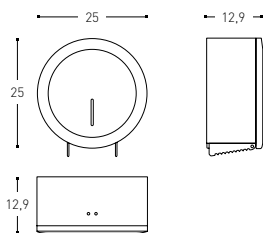

INCH 9.8x9.8x5



△
HYGIENIC PLASTIC BAGS DISPENSER
PORTABOLSITAS HIGIENICAS

290 0128

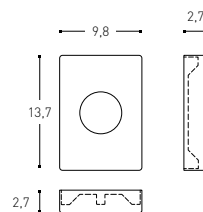

INCH 3.8x1.0x5.4



○
FREE STANDING TOILET BRUSH
ESCOBILLERO SUELO

290 0224

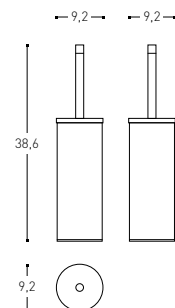

INCH 3.6x3.6x15.2



TOILET BRUSH
ESCOBILLERO

290 02 23

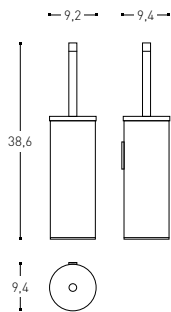

INCH 3.6x3.7x15.2



FREE-STANDING OR WALL MOUNTABLE TOILET BRUSH
ESCOBILLERO SUELO / PARED

251 01 00

251 01 00D

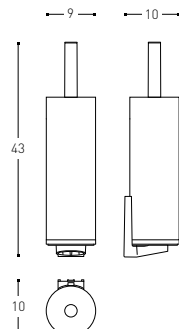

INCH 9.6x3.5x1.8



TOILET BRUSH
ESCOBILLERO

205 01 00

205 01 00D

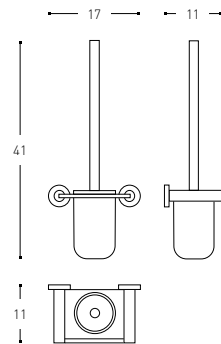

INCH 6.7x4.3x11.8



WASTE BIN
PAPELERA

290 07 02

3L

290 07 03

5L

290 07 04

12L

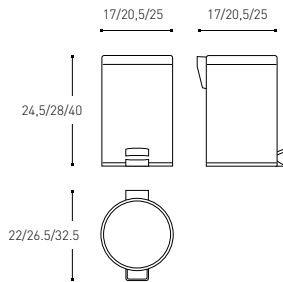

INCH 6.7/8.1/9.8x6.7/8.1/9.8x9.6/11/15.7



BASKET FOR SHOWER BAR
CONTAINER PARA BARRA DUCHA

290 01 33

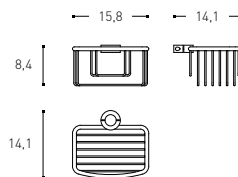

INCH 6.2x5.5x3.3



SHOWER SEAT
ASIENTO DUCHA

290 06 34

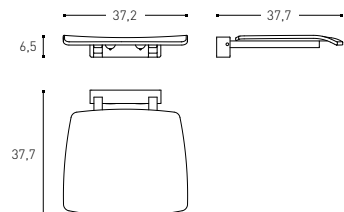

INCH 14.6x14.8x2.5





○
 EXTENSIBLE CLOTHE-LINE
 TENEDERO EXTENSIBLE

290 02 19

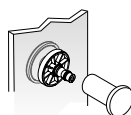
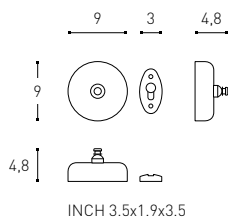

GLASS SHOWER ENCLOSURE HOLDER FOR HOOK
 SOPORTE MAMPARA PARA COLGADOR

205 01 41
 NOT SUITABLE FOR REFERENCE 205 01 67
 NO VÁLIDO PARA REF. 205 01 67

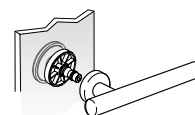
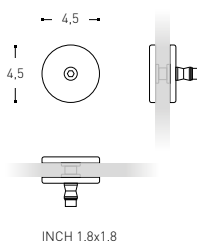

GLASS SHOWER ENCLOSURE HOLDER FOR TOWEL RACK
 SOPORTE MAMPARA PARA TOALLERO

205 01 40

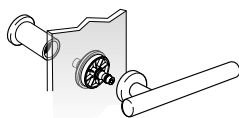
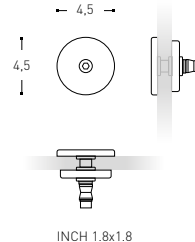

GLASS SHOWER ENCLOSURE HOLDER
 FOR TOWEL RACK / HOOK
 SOPORTE MAMPARA PARA TOALLERO / COLGADOR

205 01 38

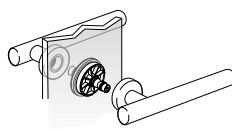
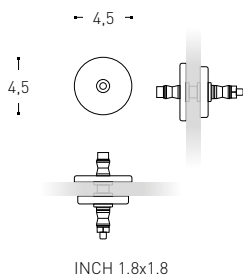

GLASS SHOWER ENCLOSURE HOLDER
 FOR TOWEL RACK / TOWEL RACK
 SOPORTE MAMPARA PARA TOALLERO / TOALLERO

205 01 42

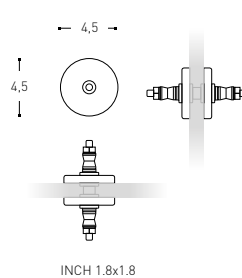

Spare parts | Recambios

DRYWALL ANCHOR TACO PLADUR

3410636

SPARE PART OF / RECAMBIO DE
2050100, 2050103, 2050120, 2050122, 2050132, 2050133, 2050144, 2050145, 2050146, 2050152, 2050153, 2050157, 2050121, 2510100, 2050158, 2050159, 2050161, 2050164, 2050165, 2050166, 2050167, 2050168, 2050169, 2050171, 2050172, 2400175, 2900168, 2900210, 2900211, 2900212, 2900213, 2900214, 2900215, 2900216, 2900230, 2900239

SCREW MOUNTING SET (M5/M6) JUEGO BIS SUJECIÓN (M5/M6)

3309100

SPARE PART OF / RECAMBIO DE
2050120, 2050121, 2050122, 2050168, 2050169, 2050157, 2050158, 2050164, 2050165, 2050166, 2050167, 2050171, 2050172, 2050121D, 2050157D, 2050158D, 2050161D, 2050164D, 2050165D, 2050166D, 2050167D, 2050168D, 2050171D, 2050172D, 2400175

ROUND WALL MOUNTING SET ACCESORIO SUJECIÓN PARED REDONDO

3307600

SPARE PART OF / RECAMBIO DE
2050164, 2050165, 2050166, 2050161, 2050171, 2050172, 2050158, 2050157

WALL MOUNTING SET ACCESORIO SUJECIÓN PARED

3410048

SPARE PART OF / RECAMBIO DE
2400175

SHELF MOUNTING SET ACCESORIO SUJECIÓN ESTANTE

3307900

SPARE PART OF / RECAMBIO DE
2050144

SOAP DISH / SHELF MOUNTING SET ACCESORIO SUJECIÓN JABONERA/ESTANTE

3308700

SPARE PART OF / RECAMBIO DE
2050132, 2050133, 2050144, 2050145, 2050146

WALL MOUNTING SET ACCESORIO SUJECIÓN PARED

3410121

SPARE PART OF / RECAMBIO DE
2050103, 2050153

3410614

SPARE PART OF / RECAMBIO DE
2050168, 2050169, 2400175

GRAB BAR MOUNTING SET ACCESORIO SUJECIÓN PARED ASA

3410633

SPARE PART OF / RECAMBIO DE
2900213, 2900214, 2900215, 2900216

3410749

SPARE PART OF / RECAMBIO DE
2900126

BASIC MOUNTING SET ACCESORIO SUJECIÓN BÁSICO

3410018

SPARE PART OF / RECAMBIO DE
2050159, 2050158, 2050157

WALL MOUNTING SET ACCESORIO SUJECIÓN PARED

3410628

SPARE PART OF / RECAMBIO DE
2900220

3410649

SPARE PART OF / RECAMBIO DE
2900223

WALL MOUNTING SET HOOK SOPORTE PARED COLGADOR

3410671

SPARE PART OF / RECAMBIO DE
2050121D

WALL MOUNTING SET HOOK, TOWEL RING, PAPER HOLDER WITHOUT COVER, TOWEL BAR SOPORTE PARED COLGADOR, ARO, PORTAPAPEL S/T, TOALLEROS

3410663

SPARE PART OF / RECAMBIO DE
2050121D, 2050157D, 2050158D, 2050161D, 2050164D, 2050165D, 2050166D, 2050167D, 2050171D, 2050196

WALL MOUNTING SET SOAP DISH, GLASS/ BRUSH-HOLDER, TOILET BRUSH SOPORTE PARED JABONERA, PORTAVASO ESTANTE, ESCOBILLERO

3410667

SPARE PART OF / RECAMBIO DE
2050100D, 2050132D, 2050133D, 2050144D, 2050145D, 2050146D, 2050152D

WALL MOUNTING SET SOAP DISPENSER, TUMBLER SOPORTE PARED, DOSIFICADOR Y VASO

3410673

SPARE PART OF / RECAMBIO DE
2050103D, 2050153D

WALL MOUNTING SET TOWEL RACK SHELF SOPORTE PARED TOALLERO ESTANTE

3410669

SPARE PART OF / RECAMBIO DE
2050168, 2050168D, 2050169, 2400175, 2900168, 2900168D

GRAB BAR DOUBLE WALL SUPPORT SET SOPORTE PARED DOBLE ASA

3410632

SPARE PART OF / RECAMBIO DE
2900210, 2900211, 2900212, 2900213, 2900214, 2900215, 2900216

HINGED GRAB BAR WALL SUPPORT SET SOPORTE PARED ASA ABATIBLE

3410634

SPARE PART OF / RECAMBIO DE
2900217, 2900218



WALL MOUNTING SET TOILET BRUSH
SOPORTE PARED ESCOBILLERO

3410666

SPARE PART OF / RECAMBIO DE
2510100D

FLANGE FOR HANDGRIP
EMBELLECEDOR ASA

3410750

SPARE PART OF / RECAMBIO DE
2900126

2 WALL MOUNTING SET + KIT SMARTFIX
KIT SMARTFIX + SOPORTE TOALLERO ESTANTE

3410715

SPARE PART OF / RECAMBIO DE
2050168D, 2900168D

KIT SMARTFIX+WALL MOUNTING SET SOAP DISPENSER,TUMBLER
KIT SMARTFIX + SOPORTE DOSIFICADOR, VASO

3410681

SPARE PART OF / RECAMBIO DE
2050103D, 2050153D

KIT SMARTFIX+ 2 WALL MOUNTING SET TOWEL BAR
KIT SMARTFIX+2 SOPORTES TOALLEROS

3410677

SPARE PART OF / RECAMBIO DE
2050161D, 2050164D, 2050165D, 2050166D

KIT SMARTFIX+WALL MOUNTING SE TOWEL RING, PAPER HOLDER WITHOUT COVER
KIT SMARTFIX + SOPORTE ARO, PORTAPAPEL S/T

3410678

SPARE PART OF / RECAMBIO DE
2050157D, 2050158D, 2050167D, 2050171D, 2050172D, 2050196D

KIT SMARTFIX+2 WALL MOUNTING SET SOAP DISH,BRUSH-HOLDER,TOILET BRUSH
KIT SMARTFIX+2 SOPORTE JABONERA, PORTAVASO ESTANTES, ESCOBILLERO

3410680

SPARE PART OF / RECAMBIO DE
2050100D, 2050132D, 2050133D, 2050144D, 2050145D, 2050146D, 2050152D

KIT SMARTFIX+WALL MOUNTING SET TOILET BRUSH
KIT SMARTFIX + SOPORTE ESCOBILLERO

3410679

SPARE PART OF / RECAMBIO DE
2510100D

KIT SMARTFIX TOWEL RING, PAPER HOLDER WITHOUT COVER
KIT SMARTFIX TOALLERO ARO, PORTAPAPEL S/T

3410664

SPARE PART OF / RECAMBIO DE
2050121D, 2050157D, 2050158D, 2050161D, 2050164D, 2050165D, 2050166D, 2050167D,
2050171D

KIT SMARTFIX SOAP DISH,GLASS/ BRUSH-HOLDER, TOILET BRUSH
KIT SMARTFIX JABONERA,PORTAVASO ESTANTE, ESCOBILLERO

3410668

SPARE PART OF / RECAMBIO DE
2050100D, 2050132D, 2050133D, 2050144D, 2050145D, 2050146D, 2050152D

KIT SMARTFIX SOAP DISPENSER,TUMBLER
KIT SMARTFIX DOSIFICADOR,VASO

3410674

SPARE PART OF / RECAMBIO DE
2050103D, 2050153D

KIT SMARTFIX TOWEL RACK SHELF
KIT SMARTFIX TOALLERO ESTANTE

3410670

SPARE PART OF / RECAMBIO DE
2050168D, 2900168D

ADHESIVE KIT PAPER HOLDER WITH COVER
KIT ADHESIVO PORTAPAPEL C/TAPA

3410672

SPARE PART OF / RECAMBIO DE
2050159D

KIT SMARTFIX TOILET BRUSH
KIT SMARTFIX ESCOBILLERO

3410665

SPARE PART OF / RECAMBIO DE
2510100D

GLUE
COLA

3410714

SPARE PART OF / RECAMBIO DE
2050121D, 2050132D, 2050133D, 2050152D, 2050153D, 2050103D, 2050144D, 2050145D,
2050146D, 2050167D, 2050164D, 2050165D, 2050166D, 2050161D, 2050171D, 2050172D,
2900168D, 2050159D, 2050158D, 2050157D, 2510100D, 2050100D

TUMBLER
VASO

3302731

SPARE PART OF / RECAMBIO DE
2050152

DISPENSER PUSH BUTTON + PUMP
PULSADOR + BOMBA DOSIFICADOR

3410615

SPARE PART OF / RECAMBIO DE
2050103, 2050104

DISPENSER PUMP
BOMBA DOSIFICADOR

3410682

SPARE PART OF / RECAMBIO DE
2050103, 2050104

SHELF
ESTANTE

3303130

SPARE PART OF / RECAMBIO DE
2050145

3303530

SPARE PART OF / RECAMBIO DE
2050144, 2310144

WALL MOUNTING SET (1 SCREW)
ACCESORIO SUJECIÓN PARED (1 TORNILLO)

3308600

SPARE PART OF / RECAMBIO DE
2050120

Spare parts | Recambios

CROSS AXIS PAPER HOLDER
EJE PORTAPAPEL

3500600

SPARE PART OF / RECAMBIO DE
2050159

TOILET BRUSH GLASS
VASO ESCOBILLERO

3308300

SPARE PART OF / RECAMBIO DE
2050100

TOILET BRUSH STICK WITH BRUSH
PALO ESCOBILLERO CON CEPILLO

3400401

SPARE PART OF / RECAMBIO DE
2050100

3409017

SPARE PART OF / RECAMBIO DE
2510100

TOILET BRUSH STICK WITH BRUSH + COVER
PALO ESCOBILLERO CON CEPILLO + TAPA

3410648

SPARE PART OF / RECAMBIO DE
2900223, 2900224

TOILET BRUSH BRUSH
CEPILLO ESCOBILLERO

3501100

SPARE PART OF / RECAMBIO DE
2510100

BLACK TOILET BRUSH BRUSH
CEPILLO ESCOBILLERO NEGRO

3410313

SPARE PART OF / RECAMBIO DE
2050100, 20510100

3410735

SPARE PART OF / RECAMBIO DE
290223, 290224

TOILET BRUSH STICK WITH BRUSH
PALO ESCOBILLERO CON CEPILLO

3410747

SPARE PART OF / RECAMBIO DE
2900223, 2900224



Bath Life

Design by **Carles Ferruz**

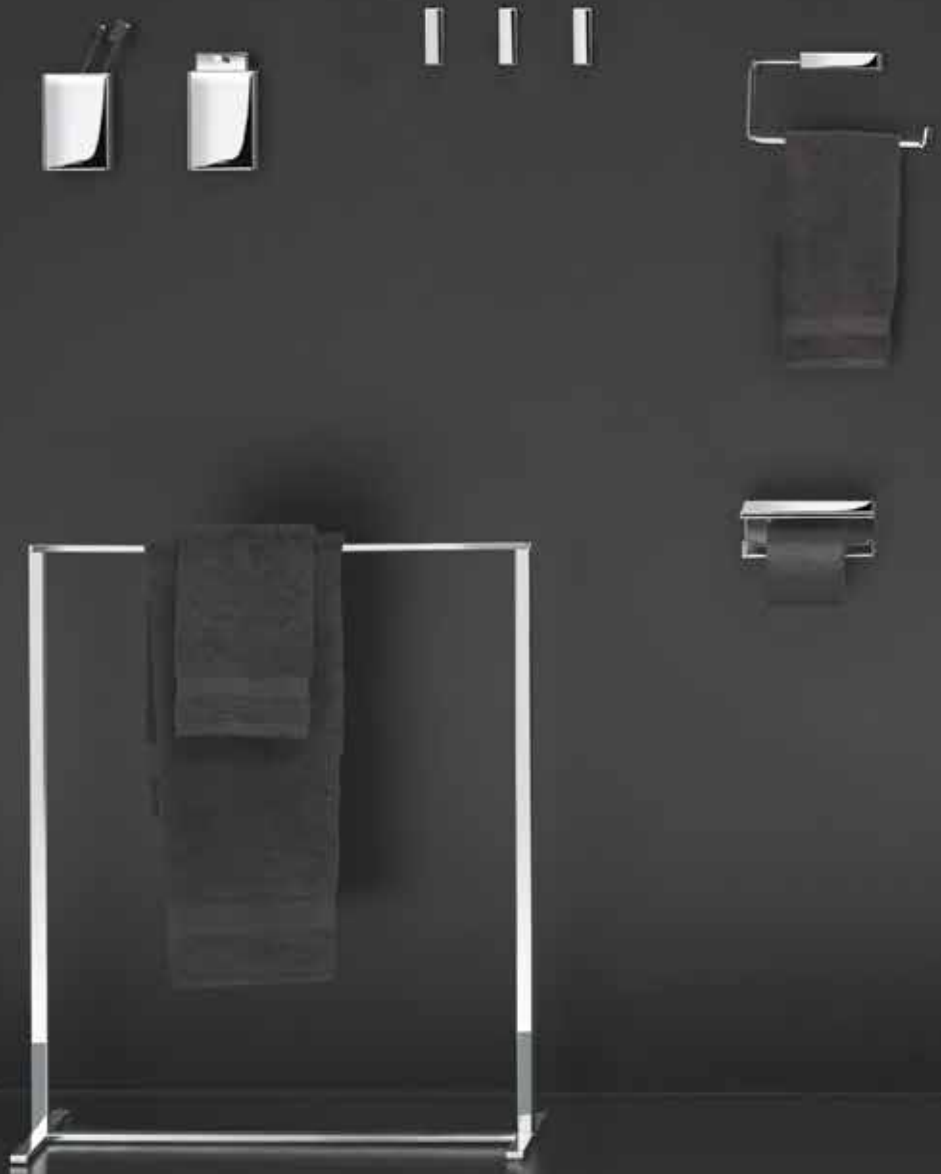





229 01 59
PAPER HOLDER WITH COVER
PORTAPAPEL CON TAPA
(16X12X6)

229 01 00
FREE-STANDING OR WALL TOILET BRUSH
ESCOBILLERO SUELO/PARED
(8X9X50)



Set of perfectly straight lines and angles within an exclusive and timeless design.

Conjugación de líneas y ángulos rectos perfectos, de diseño exclusivo y atemporal.

229 05 53
CONTAINER
PORTA-OBJETOS
(12X12X12)

229 01 40
SHELF RACK
BARRA ESTANTE
(30X12X2)

229 01 60
SHELF RACK
BARRA ESTANTE
(60X12X2)



Bath Life

Design by **Carles Ferruz**





Bath Life has successfully passed the high demanding tests of long last durability and resistance to extreme uses (static charge or impact testing) to assure long last durability of the product.

Toda la gama **Bath Life** ha superado con éxito exigentes tests de durabilidad y resistencia a usos extremos (cargas estáticas o test de impacto), para asegurar una larga vida al producto.

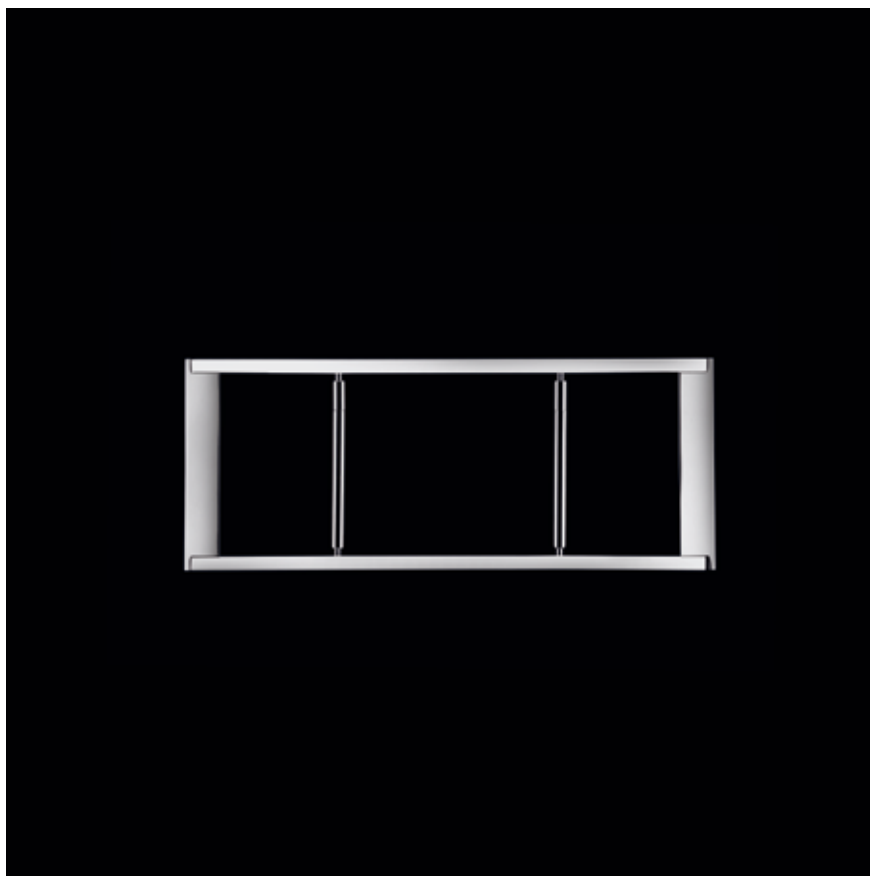

FEATURES / CARACTERÍSTICAS

Easy installation: double pitch screw.
Hidden attachments. Anti-corrosion.

Fácil instalación: tornillo de doble paso.
Fijaciones ocultas. Anticorrosión.

FINISHES / ACABADOS

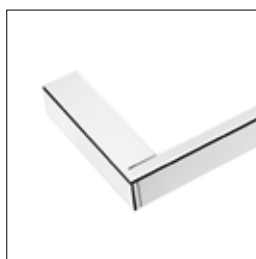

Chrome
Cromo



White
Blanco





⊙
HOOK
COLGADOR

229 0121

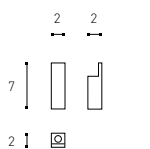

INCH 0.8x0.8x2.7



⊙
FREE STANDING BRUSH-HOLDER
PORTACEPILLOS ENCIMERA

229 0151

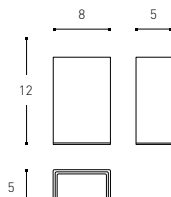

INCH 3.1x2.8x4.7



⊙
BRUSH-HOLDER
PORTACEPILLOS

229 0152

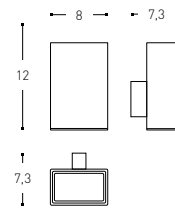

INCH 3.1x1.9x4.7



⊙
FREE STANDING SOAP DISPENSER
DOSIFICADOR ENCIMERA

229 0104

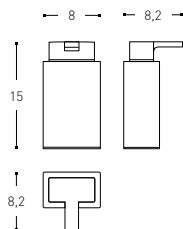

INCH 3.1x3.2x5.9



⊙
SOAP DISPENSER
DOSIFICADOR

229 0105

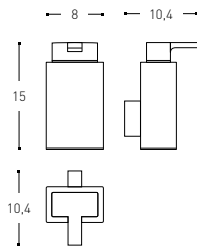

INCH 3.1x4x5.9



⊙
TOWEL RACK
TOALLERO

229 0163
30 CM / INCH 11.8
229 0164
60 CM / INCH 23.6
229 0169
45 CM / INCH 17.7
229 0165
90 CM / INCH 35.4

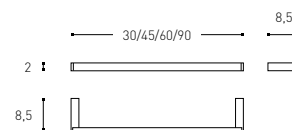

INCH 11.8/17.7/23.6/35.4x3.3x0.8



⊙
SWIVEL TOWEL RACK
TOALLERO GIRATORIO

229 0174

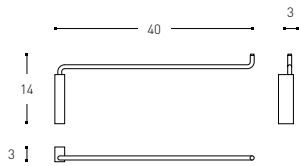

INCH 15.7x1.2x0.8



⊙
TOWEL RING
TOALLERO ARO

229 0171

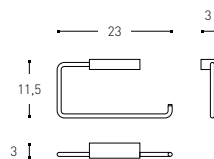

INCH 9x1.2x4.5



⊙
TOWEL RACK SHELF
TOALLERO ESTANTE

229 0168

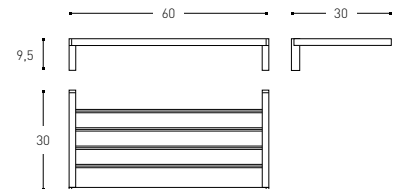

INCH 23.6x11.8x3.7



⊙
FREE STANDING TOWEL RACK
TOALLERO DE PIE

229 0166

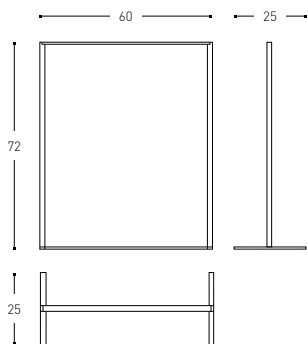

INCH 23.6x9.8x28.3



△
DISH
BANDEJA

229 0533

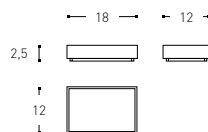

INCH 7.1x4.7x1



△
CONTAINER
PORTA-OBJETOS

229 0553

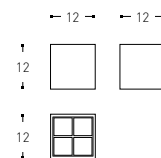

INCH 4.7x4.7x4.7



Bath Life

Design by **Carles Ferruz**



☉
SHELF RACK
BARRA ESTANTE

229 0140
30 CM / INCH 11.8
229 0160
60 CM / INCH 23.6
229 0170
90 CM / INCH 35.4

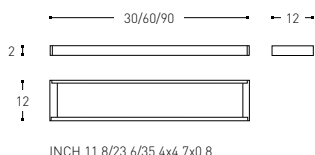

●
SHELF
ESTANTE

229 0545
30 CM / INCH 11.8
229 0546
60 CM / INCH 23.6
229 0547
90 CM / INCH 35.4

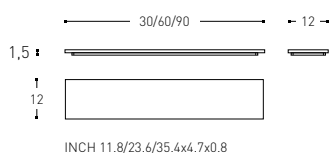

☉
PAPER HOLDER WITH COVER
PORTAPEL CON TAPA

229 0156

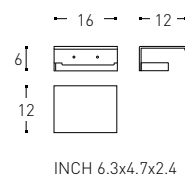

☉
PAPER HOLDER WITH COVER
PORTAPEL CON TAPA

229 0159

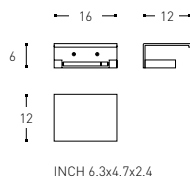

☉
PAPER HOLDER WITHOUT COVER
PORTAPEL SIN TAPA

229 0162

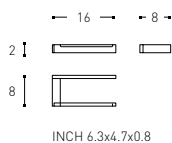

☉
PAPER HOLDER WITHOUT COVER
PORTAPEL SIN TAPA

229 0158

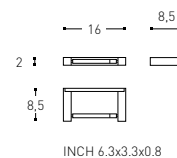



DOUBLE PAPER HOLDER WITHOUT COVER
PORTAPAPEL DOBLE SIN TAPA

229 01 57

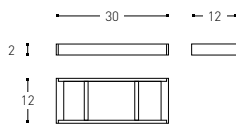

INCH 11.8x4.7x0.8



FREE-STANDING OR WALL TOILET BRUSH
ESCOBILLERO SUELO/PARED

229 01 00

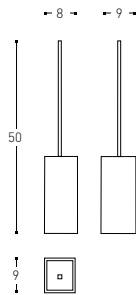

INCH 3.1x3.5x19.7



Bath Life

Design by **Carles Ferruz**

DRYWALL ANCHOR
TACO PLADUR

3410635

SPARE PART OF / RECAMBIO DE
2290156, 2290162

3410636

SPARE PART OF / RECAMBIO DE
2290100, 2290105, 2290121, 2290140, 2290152, 2290157, 2290158, 2290159, 2290160,
2290163, 2290164, 2290165, 2290168, 2290169, 2290171, 2290174

SCREW MOUNTING SET (M5/M6)
JUEGO BIS SUJECIÓN (M5/M6)

3309100

SPARE PART OF / RECAMBIO DE

WALL MOUNTING SET (1 SCREW)
ACCESORIO SUJECIÓN PARED (1 TORNILLO)

3308600

SPARE PART OF / RECAMBIO DE
2290140, 2290157, 2290158, 2290160, 2290163, 2290164, 2290165, 2290169, 2290170

MOUNTING SET
ACCESORIO SUJECIÓN

3410046

SPARE PART OF / RECAMBIO DE
2290121

3410675

SPARE PART OF / RECAMBIO DE
2290156

3410676

SPARE PART OF / RECAMBIO DE*
2290162

BASIC MOUNTING SET
ACCESORIO SUJECIÓN BÁSICO

3410018

SPARE PART OF / RECAMBIO DE
2290100, 2290159

TRIPLE MOUNTING SET
ACCESORIO SUJECIÓN TRIPLE

3410122

SPARE PART OF / RECAMBIO DE
2290168, 2290174

TRIPLE PLASTIC MOUNTING SET
ACCESORIO SUJECIÓN PLÁSTICO TRIPLE

3410125

SPARE PART OF / RECAMBIO DE
2900171

SHELF MOUNTING SET
ACCESORIO SUJECIÓN ESTANTE

3410303

SPARE PART OF / RECAMBIO DE
2290140, 2290160, 2290170

TOILET BRUSH FIXATION SET
ACCESORIO SUJECION ESCOBILLERO

3410307

SPARE PART OF / RECAMBIO DE
2290100

DISPENSER PUSH BUTTON + PUMP
BOMBA-PULSADOR DOSIF. BATHLIFE CROMO

3410650

SPARE PART OF / RECAMBIO DE
2290104, 2290105

DISPENSER PUMP
BOMBA DOSIFICADOR

3410682

SPARE PART OF / RECAMBIO DE
2290104, 2290105

CROSS AXIS DOUBLE PAPER HOLDER
EJE PORTAPEPEL DOBLE

3410323

SPARE PART OF / RECAMBIO DE
2290157

CROSS AXIS PAPER HOLDER
EJE PORTAPEPEL

3410324

SPARE PART OF / RECAMBIO DE
2290158, 2290159

TOILET BRUSH GLASS
VASO ESCOBILLERO

3410030

SPARE PART OF / RECAMBIO DE
2290100

TOILET BRUSH STICK WITH BRUSH
PALO ESCOBILLERO CON CEPILLO

3410041

SPARE PART OF / RECAMBIO DE
2290100

TOILET BRUSH BRUSH
CEPILLO ESCOBILLERO

3501100

SPARE PART OF / RECAMBIO DE
2290100

3410313

SPARE PART OF / RECAMBIO DE
2290100



Black & White

Design by **Cosmic Studio**







The classic colour contrast transforms the bathroom into a bold atmosphere or blends it in to the other components to create harmonious and diaphanous environments.

El contraste cromático más clásico permite transformar el baño en un ambiente atrevido o bien fundirse con el resto de elementos para convertir los entornos en armónicos y diáfanos.

Black & White

Design by Cosmic Studio





Black & White has successfully passed the high demanding tests of long last durability and resistance to extreme uses (static charge or impact testing) to assure long last durability of the product.

Toda la gama **Black & White** ha superado con éxito exigentes tests de durabilidad y resistencia a usos extremos (cargas estáticas o test de impacto), para asegurar una larga vida al producto.



FEATURES / CARACTERÍSTICAS

Easy installation: double pitch screw.
Hidden attachments. Anti-corrosion.
Lead free paint.

Fácil instalación: tornillo de doble paso.
Fijaciones ocultas. Anticorrosión.
Pintura libre de plomo.

FINISHES / ACABADOS



Glossy black
Negro brillo



Glossy white
Blanco brillo



Matte black
Negro mate

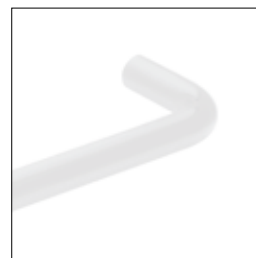

Matte white
Blanco mate



Black & White

Design by Cosmic Studio



⊙
HOOK
COLGADOR

238 15 21
GLOSSY WHITE /BLANCO BRILLO
238 06 21
GLOSSY BLACK /NEGRO BRILLO
238 65 21
MATTE WHITE /BLANCO MATE
238 36 21
MATTE BLACK /NEGRO MATE

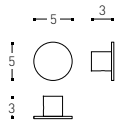

INCH 2x1.2x2



⊙
GLOVE HOOK
PORTAGUANTES

238 15 20
GLOSSY WHITE /BLANCO BRILLO
238 06 20
GLOSSY BLACK /NEGRO BRILLO
238 65 20
MATTE WHITE /BLANCO MATE
238 36 20
MATTE BLACK /NEGRO MATE

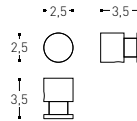

INCH 1x1.4x1



⊙
FREE STANDING BRUSH-HOLDER
PORTACEPILLOS ENCIMERA

251 05 53
GLOSSY WHITE /BLANCO BRILLO
251 06 53
GLOSSY BLACK /NEGRO BRILLO
251 65 53
MATTE WHITE /BLANCO MATE
251 36 53
MATTE BLACK /NEGRO MATE

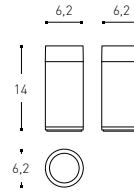

INCH 2.4x2.4x5.5



⊙
BRUSH-HOLDER
PORTACEPILLOS

251 05 54
GLOSSY WHITE /BLANCO BRILLO
251 06 54
GLOSSY BLACK /NEGRO BRILLO
251 65 54
MATTE WHITE /BLANCO MATE
251 36 54
MATTE BLACK /NEGRO MATE

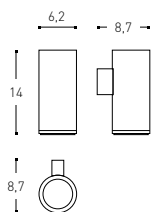

INCH 2.4x3.4x5.5



⊙
FREE STANDING SOAP DISPENSER
DOSIFICADOR ENCIMERA

251 05 04
GLOSSY WHITE /BLANCO BRILLO
251 06 04
GLOSSY BLACK /NEGRO BRILLO
251 65 04
MATTE WHITE /BLANCO MATE
251 36 04
MATTE BLACK /NEGRO MATE

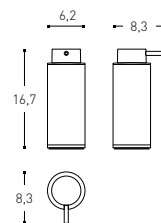

INCH 2.4x3.3x6.6



⊙△
SOAP DISPENSER
DOSIFICADOR

251 05 05
GLOSSY WHITE /BLANCO BRILLO
251 06 05
GLOSSY BLACK /NEGRO BRILLO
251 65 05
MATTE WHITE /BLANCO MATE
251 36 05
MATTE BLACK /NEGRO MATE

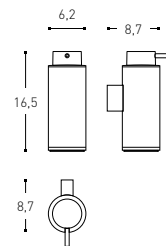

INCH 2.4x3.4x6.6



⊙△
BASKET
CONTAINER

- 251 05 49**
GLOSSY WHITE /BLANCO BRILLO
- 251 06 49**
GLOSSY BLACK /NEGRO BRILLO
- 251 65 49**
MATTE WHITE /BLANCO MATE
- 251 36 49**
MATTE BLACK /NEGRO MATE

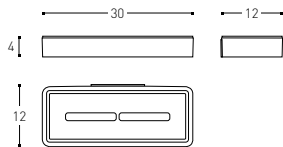

INCH 11.8x4.7x1.6



⊙△◇
FREE STANDING MAGNIFYING MIRROR
ESPEJO AUMENTO ENCIMERA

- 251 05 83**
(x3) GLOSSY WHITE /BLANCO BRILLO
- 251 06 83**
(x3) GLOSSY BLACK /NEGRO BRILLO
- 251 65 83**
(x3) MATTE WHITE /BLANCO MATE
- 251 36 83**
(x3) MATTE BLACK /NEGRO MATE

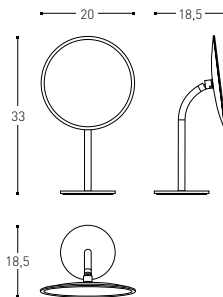

INCH 7.9x7.3x13



⊙△◇
WALL MAGNIFYING MIRROR
ESPEJO DE AUMENTO PARED

- 251 05 85**
(x3) GLOSSY WHITE /BLANCO BRILLO
- 251 06 85**
(x3) GLOSSY BLACK /NEGRO BRILLO
- 251 65 85**
(x3) MATTE WHITE /BLANCO MATE
- 251 36 85**
(x3) MATTE BLACK /NEGRO MATE

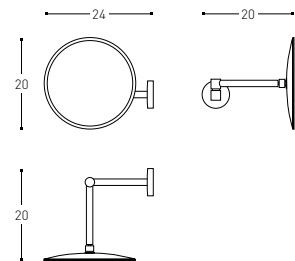

INCH 9.4x7.9x7.9



⊙
TOWEL RACK
TOALLERO

- 238 15 64**
40CM GLOSSY WHITE /BLANCO BRILLO
- 238 06 64**
40CM GLOSSY BLACK /NEGRO BRILLO
- 238 65 64**
40CM MATTE WHITE /BLANCO MATE
- 238 36 64**
40CM MATTE BLACK /NEGRO MATE
- 238 15 65**
60CM GLOSSY WHITE /BLANCO BRILLO
- 238 06 65**
60CM GLOSSY BLACK /NEGRO BRILLO
- 238 65 65**
60CM MATTE WHITE /BLANCO MATE
- 238 36 65**
60CM MATTE BLACK /NEGRO MATE

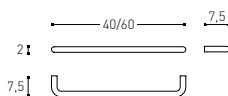

INCH 15.7/23.6x2.9x0.8



⊙
SWIVEL DOUBLE TOWEL RACK
TOALLERO GIRATORIO DOBLE

- 251 05 75**
GLOSSY WHITE /BLANCO BRILLO
- 251 06 75**
GLOSSY BLACK /NEGRO BRILLO
- 251 65 75**
MATTE WHITE /BLANCO MATE
- 251 36 75**
MATTE BLACK /NEGRO MATE

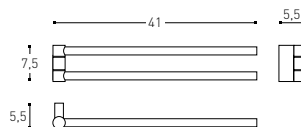

INCH 16.1x2.2x2.9



⊙
TOWEL RING
TOALLERO ARO

- 251 05 71**
GLOSSY WHITE /BLANCO BRILLO
- 251 06 71**
GLOSSY BLACK /NEGRO BRILLO
- 251 65 71**
MATTE WHITE /BLANCO MATE
- 251 36 71**
MATTE BLACK /NEGRO MATE

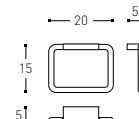

INCH 7.9x2x5.9

Black & White

Design by Cosmic Studio

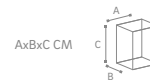

TOWEL RACK SHELF
TOALLERO ESTANTE

- 251 05 68**
GLOSSY WHITE /BLANCO BRILLO
- 251 06 68**
GLOSSY BLACK /NEGRO BRILLO
- 251 65 68**
MATTE WHITE /BLANCO MATE
- 251 36 68**
MATTE BLACK /NEGRO MATE

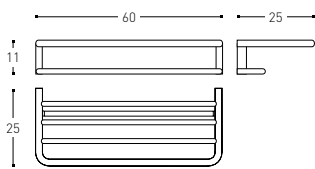

INCH 23.6x9.8x4.3



PAPER HOLDER WITH COVER
PORTAPAPEL CON TAPA

- 238 05 59**
GLOSSY WHITE /BLANCO BRILLO
- 238 06 59**
GLOSSY BLACK /NEGRO BRILLO
- 238 65 59**
MATTE WHITE /BLANCO MATE
- 238 36 59**
MATTE BLACK /NEGRO MATE

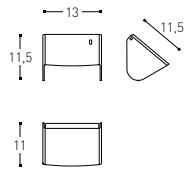

INCH 5.1x4.5x4.5



NEW*



PAPER HOLDER WITHOUT COVER
PORTAPAPEL SIN TAPA

- 251 05 58**
GLOSSY WHITE /BLANCO BRILLO
- 251 06 58**
GLOSSY BLACK /NEGRO BRILLO
- 251 65 58**
MATTE WHITE /BLANCO MATE
- 251 36 58**
MATTE BLACK /NEGRO MATE

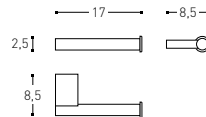

INCH 6.7x3.3x1

* REQUEST MARKET LAUNCH
* CONSULTAR FECHA DE LANZAMIENTO



PAPER HOLDER WITHOUT COVER
PORTAPAPEL SIN TAPA

- 238 15 58**
GLOSSY WHITE /BLANCO BRILLO
- 238 06 58**
GLOSSY BLACK /NEGRO BRILLO
- 238 65 58**
MATTE WHITE /BLANCO MATE
- 238 36 58**
MATTE BLACK /NEGRO MATE

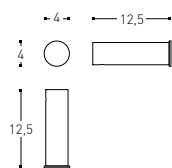

INCH 1.6x4.9x1.6



FREE-STANDING OR WALL TOILET BRUSH
ESCOBILLERO SUELO/PARED

- 251 05 00**
GLOSSY WHITE /BLANCO BRILLO
- 251 06 00**
GLOSSY BLACK /NEGRO BRILLO
- 251 65 00**
MATTE WHITE /BLANCO MATE
- 251 36 00**
MATTE BLACK /NEGRO MATE

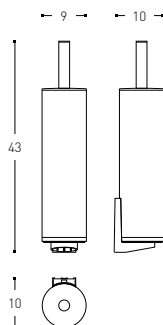

Spare parts | Recambios

DRYWALL ANCHOR
TACO PLADUR

3410636

SPARE PART OF / RECAMBIO DE
2510500, 2510505, 2510532, 2510549, 2510550, 2510554, 2510568, 2510571, 2510572,
2510575, 2510582, 2510585, 2510600, 2510605, 2510632, 2510649, 2510650, 2510654,
2510668, 2510671, 2510672, 2510675, 2510682, 2510685, 2381521, 2380621, 2380620,
2381564, 2380664, 2381565, 2380665, 2381566, 2380666, 2380545, 2380645, 2380559,
2380659, 2381558, 2380658

MOUNTING SET
ACCESORIO SUJECIÓN

3406500

SPARE PART OF / RECAMBIO DE
2380620, 2380621, 2380658, 2380664, 2380665, 2380666, 2381520, 2381521, 2381558,
2381564, 2381565, 2381566

BASIC MOUNTING SET
ACCESORIO SUJECIÓN BÁSICO

3410018

SPARE PART OF / RECAMBIO DE
2380545, 2380559, 2380645, 2380659

ROUND WALL MOUNTING SET
ACCESORIO SUJECIÓN PARED REDONDO

3307600

SPARE PART OF / RECAMBIO DE
2510568, 2510668

TRIPLE MOUNTING SET
ACCESORIO SUJECIÓN TRIPLE

3410122

SPARE PART OF / RECAMBIO DE
2510568, 2510668

TRIPLE PLASTIC MOUNTING SET
ACCESORIO SUJECIÓN PLÁSTICO TRIPLE

3410125

SPARE PART OF / RECAMBIO DE
2510571, 2510671

DISPENSER PUSH BUTTON + PUMP
PULSADOR + BOMBA DOSIFICADOR

3409021

SPARE PART OF / RECAMBIO DE
2510504, 2510505

3409022

SPARE PART OF / RECAMBIO DE
2510604, 2510605

DISPENSER PUMP
BOMBA DOSIFICADOR

3410682

SPARE PART OF / RECAMBIO DE
2510504, 2510505, 2510604, 2510605

GLASS MIRROR
LUNA ESPEJO

3410472

SPARE PART OF / RECAMBIO DE
2510683, 2510685

3410473

SPARE PART OF / RECAMBIO DE
2510583, 2510585

SHELF
ESTANTE

3406600

SPARE PART OF / RECAMBIO DE
2380545, 2380645

TOILET BRUSH STICK WITH BRUSH
PALO ESCOBILLERO CON CEPILLO

3409018

BLACK / NEGRO

SPARE PART OF / RECAMBIO DE
2510600

3409019

WHITE / BLANCO

SPARE PART OF / RECAMBIO DE
2510500

TOILET BRUSH BRUSH
CEPILLO ESCOBILLERO

3410313

BLACK / NEGRO

SPARE PART OF / RECAMBIO DE
2510500, 2510600

3501100

WHITE / BLANCO

SPARE PART OF / RECAMBIO DE
2510500, 2510600



Container

Design by **Claramunt De Mas**







Pieces created from
the perspective of design
and elegance for increasing
the comfort.

Elementos creados
desde la óptica del diseño
y la elegancia que aumentan
el confort.



Container

Design by Claramunt De Mas





Container has successfully passed the high demanding tests of long last durability and resistance to extreme uses (static charge or impact testing) to assure long last durability of the product.

Toda la gama **Container** ha superado con éxito exigentes tests de durabilidad y resistencia a usos extremos (cargas estáticas o test de impacto), para asegurar una larga vida al producto.



FEATURES / CARACTERÍSTICAS

Moisture resistant MDF with a natural wood veneer. Easy installation: double pitch screw. Hidden attachments. Anti-corrosion.

MDF hidrófugo con chapa de madera natural. Fácil instalación: tornillo de doble paso. Fijaciones ocultas. Anticorrosión.

FINISHES / ACABADOS



Ancient oak
Roble milenario



Canadian oak
Roble canadiense



Glossy chrome
Cromo brillo



Container

Design by **Claramunt De Mas**



○
HOOK
COLGADOR

775 02 21

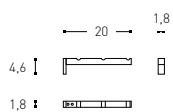

INCH 7.9x0.7x1.8



○
TOWEL RACK
TOALLERO

775 02 65
50CM

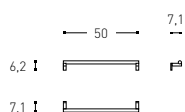

INCH 19.7x2.8x2.4



○
TOWEL RACK
TOALLERO

775 02 66
100CM

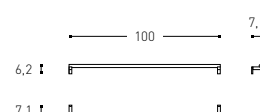

INCH 39.4x2.8x2.4



○
TOWEL RACK SHELF
TOALLERO ESTANTE

775 02 68

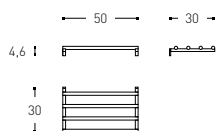

INCH 19.7x11.8x1.8



○
SHELF
ESTANTE

775 02 60
50CM

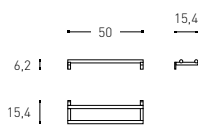

INCH 19.7x6.1x2.4



○
SHELF
ESTANTE

775 02 70
100CM

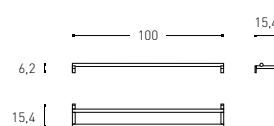

INCH 39.4x6.1x2.4



☐
SHELF
ESTANTE

775 80 46
ANCIENT OAK/ROBLE MILENARIO
775 85 46
CANADIAN OAK/ROBLE CANADIENSE

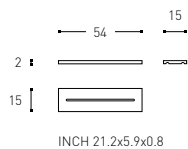

☐
BIG BASKET
CONTAINER GRANDE

775 80 49
ANCIENT OAK/ROBLE MILENARIO
775 85 49
CANADIAN OAK/ROBLE CANADIENSE

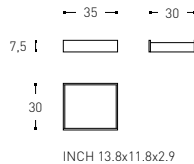

☐
SMALL BASKET
CONTAINER PEQUEÑO

775 80 48
ANCIENT OAK/ROBLE MILENARIO
775 85 48
CANADIAN OAK/ROBLE CANADIENSE

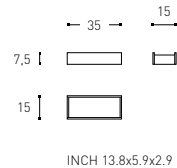

☐○
STOOL
BANQUETA

775 80 07
ANCIENT OAK/ROBLE MILENARIO
775 85 07
CANADIAN OAK/ROBLE CANADIENSE

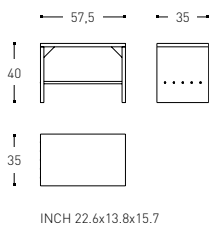

☐
STOOL
TABURETE

775 80 06
ANCIENT OAK/ROBLE MILENARIO
775 85 06
CANADIAN OAK/ROBLE CANADIENSE

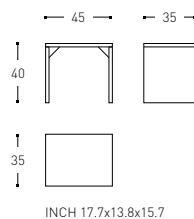

Container

Design by **Claramunt De Mas**

SCREW MOUNTING SET (M5/M6)
JUEGO BIS SUJECIÓN (M5/M6)

3309100

SPARE PART OF / RECAMBIO DE
7750221, 7750260, 7750265, 7750266, 7750268, 7750270

BASIC MOUNTING SET
ACCESORIO SUJECIÓN BÁSICO

3410018

SPARE PART OF / RECAMBIO DE
7750221, 7750260, 7750265, 7750266, 7750268, 7750270



Contract

Design by **Cosmic Studio**

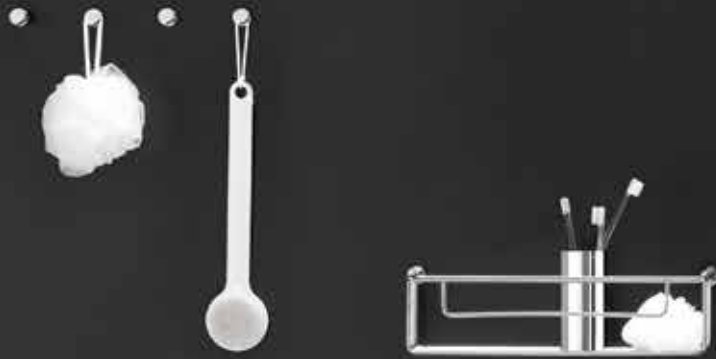







Functional forms that
do not renounce the touch
of elegance that makes
them unique.

Formas funcionales que
no renuncian a ese toque
de elegancia que las convierte
en singulares.



Contract

Design by Cosmic Studio





Contract has successfully passed the high demanding tests of long last durability and resistance to extreme uses (static charge or impact testing) to assure long last durability of the product.

Toda la gama **Contract** ha superado con éxito exigentes tests de durabilidad y resistencia a usos extremos (cargas estáticas o test de impacto), para asegurar una larga vida al producto.



FEATURES / CARACTERÍSTICAS

Easy installation: double pitch screw.
Hidden attachments. Anti-corrosion.

Fácil instalación: tornillo de doble paso.
Fijaciones ocultas. Anticorrosión.





⊙
HOOK
COLGADOR

2310121

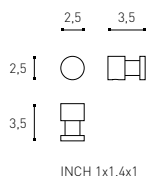

⊙◇
SOAP DISH
JABONERA

240 0132

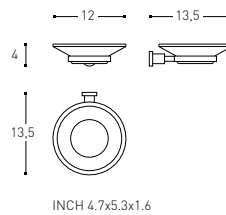

○△
FREE STANDING BRUSH-HOLDER
PORTACEPILLOS ENCIMERA

205 0151

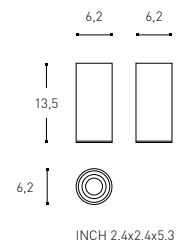

○△
BRUSH-HOLDER
PORTACEPILLOS

205 0153

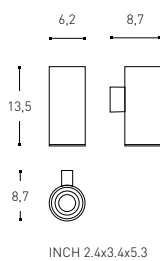

⊙
FREE STANDING SOAP DISPENSER
DOSIFICADOR ENCIMERA

205 0104

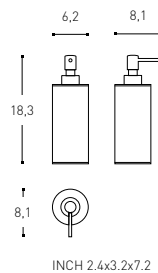

⊙
SOAP DISPENSER
DOSIFICADOR

205 0103

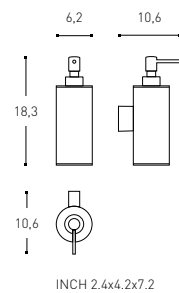



◉◆
GLASS SHELF
ESTANTE VIDRIO

231 01 44

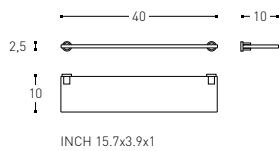

◉
BASKET
CONTAINER

231 01 49

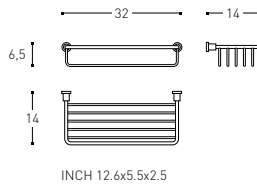

◉
BASKET
CONTAINER

231 01 48

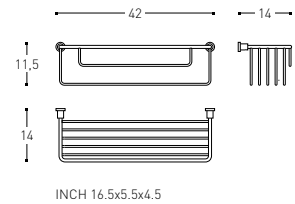

◉△
TOWEL RACK
TOALLERO

231 01 64
41.5 CM / INCH 16.3
231 01 65
58.5 CM / INCH 23

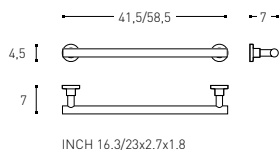

◉△
TOWEL RING
TOALLERO ARO

231 01 71
Ø 16 CM / INCH Ø 6.3
231 01 72
Ø 21 CM / INCH Ø 8.3

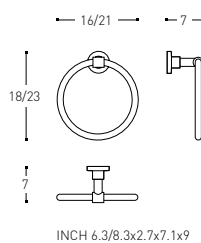

◉
TOWEL RACK SHELF
TOALLERO ESTANTE

290 01 68

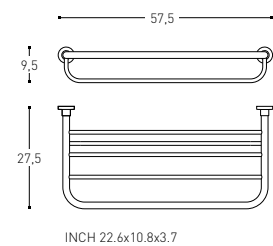



⊙△
PAPER HOLDER WITH COVER
PORTAPAPEL CON TAPA

231 01 59

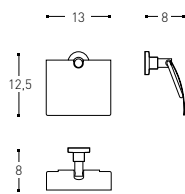

INCH 5.1x3.1x4.9



⊙△
PAPER HOLDER WITHOUT COVER
PORTAPAPEL SIN TAPA

231 01 58

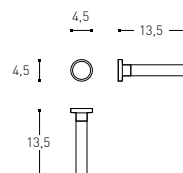

INCH 1.8x5.3x1.8



⊙◇
TOILET BRUSH
ESCOBILLERO

231 01 00

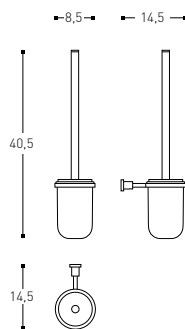

INCH 3.3x5.7x15.9



⊙○△
FREE-STANDING OR WALL TOILET BRUSH
ESCOBILLERO SUELO/PARED

251 01 00

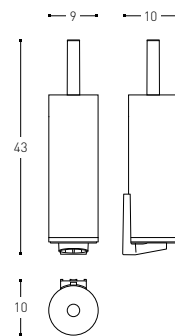

INCH 3.5x3.9x16.9

Spare parts | Recambios

DRYWALL ANCHOR
TACO PLADUR

3410636

SPARE PART OF / RECAMBIO DE
2050153, 2050103, 2510100, 2310100, 2310121, 2310144, 2310148, 2310149, 2310158,
2310159, 2310164, 2310165, 2310171, 2310172

SCREW MOUNTING SET (M5/M6)
JUEGO BIS SUJECIÓN (M5/M6)

3309100

SPARE PART OF / RECAMBIO DE

BASIC MOUNTING SET
ACCESORIO SUJECIÓN BÁSICO

3410018

SPARE PART OF / RECAMBIO DE
2310144

CONTAINER MOUNTING SET
ACCESORIO SUJECIÓN CONTAINER

3410066

SPARE PART OF / RECAMBIO DE
2310148, 2310149

WALL MOUNTING SET WITH FLANGE
ACCESORIO SOPORTE PARED CON EMBELLECEDOR

3410049

SPARE PART OF / RECAMBIO DE
2310158, 2310159, 2310164, 2310165, 2310171, 2310172

WALL MOUNTING SET
ACCESORIO SUJECIÓN PARED

3308800

SPARE PART OF / RECAMBIO DE
2310164, 2310165

SOAP DISH
JABONERA

3306000

SPARE PART OF / RECAMBIO DE
2310132

DISPENSER PUSH BUTTON + PUMP
PULSADOR + BOMBA DOSIFICADOR

3410615

SPARE PART OF / RECAMBIO DE
2050104, 2050103

DISPENSER PUMP
BOMBA DOSIFICADOR

3410682

SPARE PART OF / RECAMBIO DE
2050104, 2050103

SHELF
ESTANTE

3303530

SPARE PART OF / RECAMBIO DE
2310144

TOILET BRUSH GLASS
VASO ESCOBILLERO

3308300

SPARE PART OF / RECAMBIO DE
2310100

TOILET BRUSH STICK WITH BRUSH
PALO ESCOBILLERO CON CEPILLO

3400401

SPARE PART OF / RECAMBIO DE
2310100

3409017

SPARE PART OF / RECAMBIO DE
2310100

TOILET BRUSH BRUSH
CEPILLO ESCOBILLERO

3410313

SPARE PART OF / RECAMBIO DE
2310100, 2510100

3501100

SPARE PART OF / RECAMBIO DE
2310100, 2510100



Extreme

Design by **Cosmic Studio**







Serene balance between sober elegance of rectangular lines and the sensuality released by its smooth curves.

Sereno equilibrio entre la sobria elegancia de las líneas rectangulares y la sensualidad que desprenden sus suaves curvas.

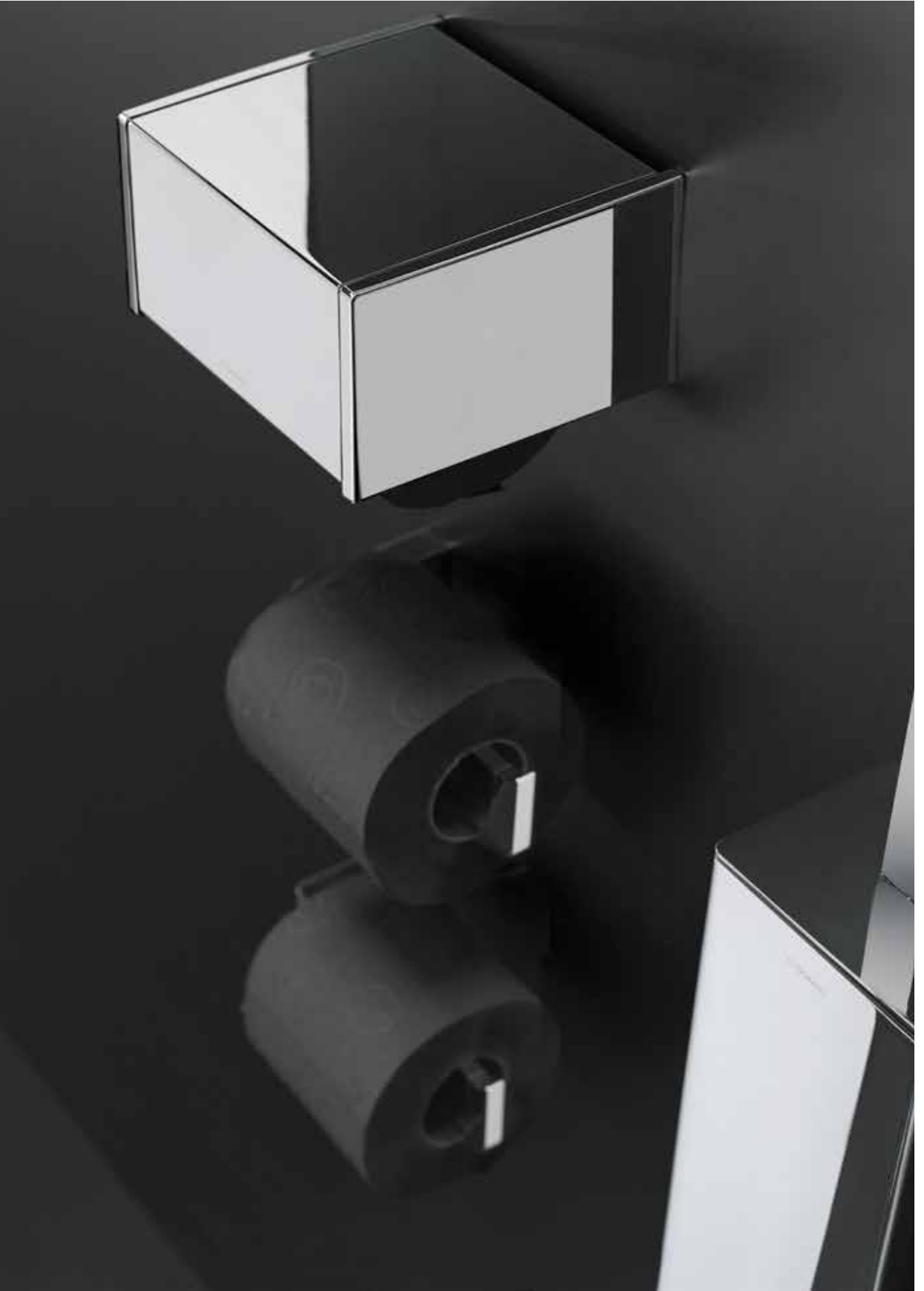

Extreme

Design by Cosmic Studio





Extreme has successfully passed the high demanding tests of long last durability and resistance to extreme uses (static charge or impact testing) to assure long last durability of the product.

Toda la gama **Extreme** ha superado con éxito exigentes tests de durabilidad y resistencia a usos extremos (cargas estáticas o test de impacto), para asegurar una larga vida al producto.

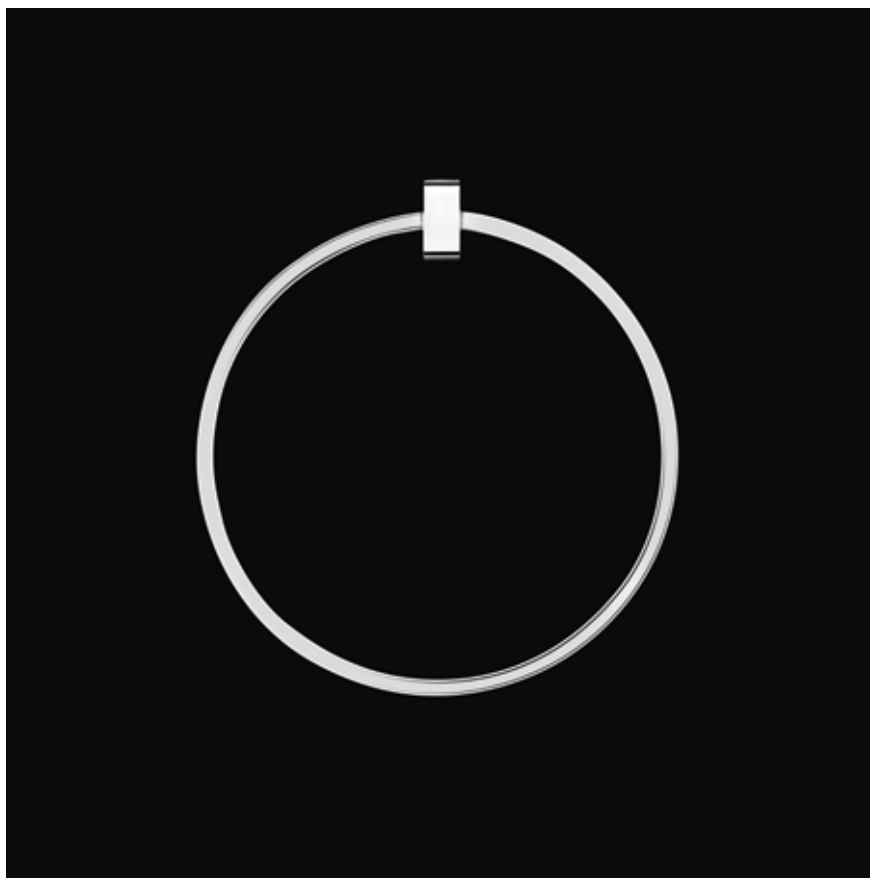

FEATURES / CARACTERÍSTICAS

Easy installation: double pitch screw.
Hidden attachments. Anti-corrosion.
Tempered glass shelf (high safety).

Fácil instalación: tornillo de doble paso.
Fijaciones ocultas. Anticorrosión.
Estante de vidrio templado (alta seguridad).

FINISHES / ACABADOS

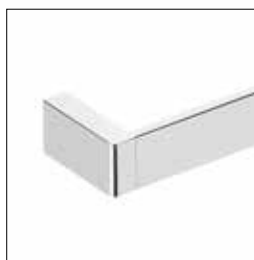

Chrome
Cromo



Chrome - black
Cromo - negro





⊙
HOOK
COLGADOR

253 01 21

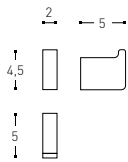

INCH 0.8x2x1.8



⊙
SOAP DISH
JABONERA

253 01 32

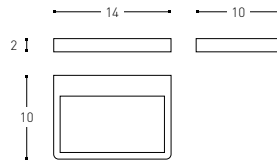

INCH 5.5x3.9x0.8



⊙△
FREE STANDING BRUSH-HOLDER
PORTACEPILLOS ENCIMERA

253 01 53

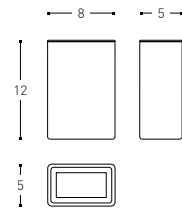

INCH 3.1x2x4.7



⊙△
BRUSH-HOLDER
PORTACEPILLOS

253 01 52

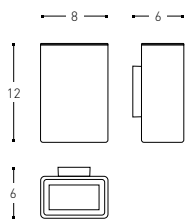

INCH 3.1x2.4x4.7



⊙△
FREE STANDING SOAP DISPENSER
DOSIFICADOR ENCIMERA

253 01 04

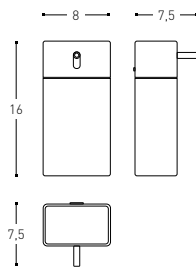

INCH 3.1x2.9x6.3



⊙△
SOAP DISPENSER
DOSIFICADOR

253 01 05

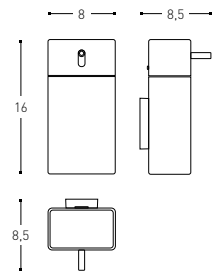

INCH 3.1x3.3x6.3



◆
SHELF
ESTANTE

253 0144
40 CM / INCH 15.7
253 0145
60 CM / INCH 23.6

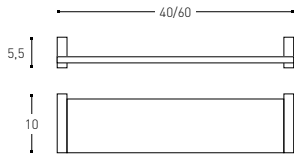

INCH 15.7/23.6x3.9x2.2



◆
TOWEL RACK SHELF
TOALLERO ESTANTE

253 0168

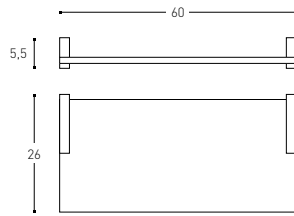

INCH 23.6x3.9x2.2



△
BASKET
CONTAINER

251 6149

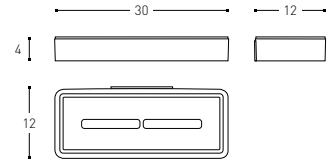

INCH 11.8x4.7x1.6



△
CORNER BASKET
CONTAINER RINCÓN

251 6150

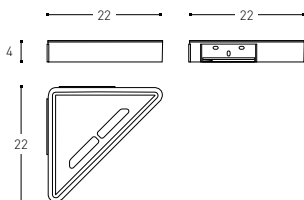

INCH 8.7x8.7x1.6



○
TOWEL RACK
TOALLERO

253 0163
30 CM / INCH 11.8
253 0164
45 CM / INCH 17.7
253 0165
60 CM / INCH 23.6
253 0166
80 CM / INCH 31.5

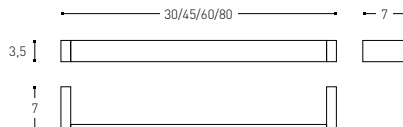

INCH 11.8/17.7/23.6/31.5x2.7x1.4



○
SWIVEL DOUBLE TOWEL RACK
TOALLERO DOBLE GIRATORIO

253 0175

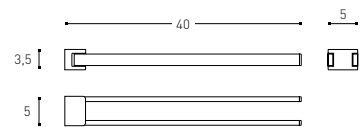

INCH 15.7x2x1.4





⊙
TOWEL RING
TOALLERO ARO

253 0171

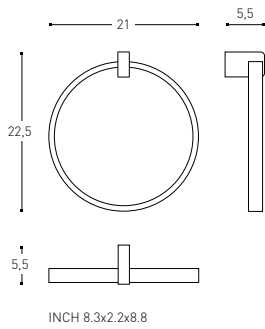

⊙△
PAPER HOLDER WITH COVER
PORTAPEPEL CON TAPA

251 0159

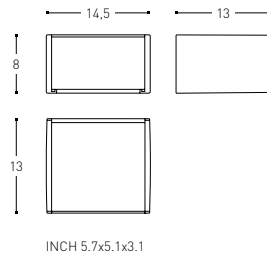

⊙
PAPER HOLDER WITHOUT COVER
PORTAPEPEL SIN TAPA

253 0158

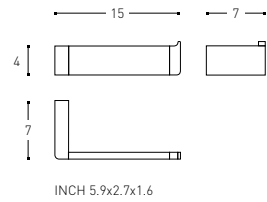

⊙△
FLOOR TOILET BRUSH
ESCOBILLERO SUELO

253 0101

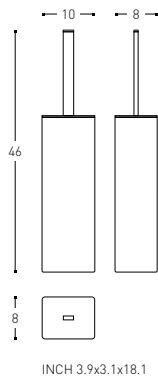

⊙△
TOILET BRUSH
ESCOBILLERO

253 0100

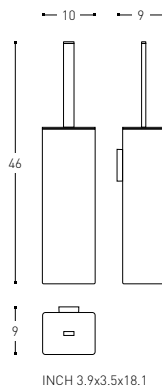

Spare parts | Recambios

DRYWALL ANCHOR
TACO PLADUR

3410636

SPARE PART OF / RECAMBIO DE
2516149, 2516150, 2510159, 2530100, 2530105, 2530121, 2530132, 2530144, 2530145,
2530152, 2530158, 2530163, 2530164, 2530165, 2530166, 2530168, 2530171, 2530175

WALL FIXATION SET HOOK/PAPER HOLDER/TOWEL RACK/TOWEL RING
ACCESORIO SUJECIÓN PARED COLGADOR/PORTAPAPEL/TOALLERO/TOALLERO ARO

3410209

SPARE PART OF / RECAMBIO DE
2530121, 2530158, 2530163, 2530164, 2530165, 2530166, 2530171

WALL FIXATION SET TOWEL RACK / SHELF
ACCESORIO SUJECIÓN PARED ESTANTE/PORTATOALLAS

3410208

SPARE PART OF / RECAMBIO DE
2530144, 2530145, 2530168

WALL MOUNTING SET
ACCESORIO SUJECIÓN PARED

3410210

SPARE PART OF / RECAMBIO DE
2530100, 2530105, 2530152

WALL FIXATION SET SWIVEL TOWEL RACK
ACCESORIO SUJECIÓN PARED TOALLERO GIRATORIO

3410211

SPARE PART OF / RECAMBIO DE
2530175

TRIPLE PLASTIC MOUNTING SET
ACCESORIO SUJECIÓN PLÁSTICO TRIPLE

3410125

SPARE PART OF / RECAMBIO DE
2530132

DISPENSER PUSH BUTTON + PUMP
PULSADOR + BOMBA DOSIFICADOR

3410657

SPARE PART OF / RECAMBIO DE
2530104, 2530105

DISPENSER PUMP
BOMBA DOSIFICADOR

3410682

SPARE PART OF / RECAMBIO DE
2530104, 2530105

SHELF
ESTANTE

3410202

SPARE PART OF / RECAMBIO DE
2530144

3410203

SPARE PART OF / RECAMBIO DE
2530145

TOWEL RACK SHELF
ESTANTE TOALLERO ESTANTE

3410205

SPARE PART OF / RECAMBIO DE
2530168

CROSS AXIS PAPER HOLDER
EJE PORTAPAPEL

3419020

SPARE PART OF / RECAMBIO DE
2510159

TOILET BRUSH STICK WITH BRUSH
PALO ESCOBILLERO CON CEPILLO

3410206

SPARE PART OF / RECAMBIO DE
2530100, 2530101

TOILET BRUSH BRUSH
CEPILLO ESCOBILLERO

3410313

SPARE PART OF / RECAMBIO DE
2530100, 2530101

3501100

SPARE PART OF / RECAMBIO DE
2530100, 2530101



Logic

Design by **Cosmic Studio**









Pieces that bring together the functions and basic forms of the bathroom to create comfortable and pleasant ambiances.

Piezas que recogen los usos y formas básicas del baño para crear ambientes confortables y cómodos.







Logic has successfully passed the high demanding tests of long last durability and resistance to extreme uses (static charge or impact testing) to assure long last durability of the product.

Toda la gama **Logic** ha superado con éxito exigentes tests de durabilidad y resistencia a usos extremos (cargas estáticas o test de impacto), para asegurar una larga vida al producto.

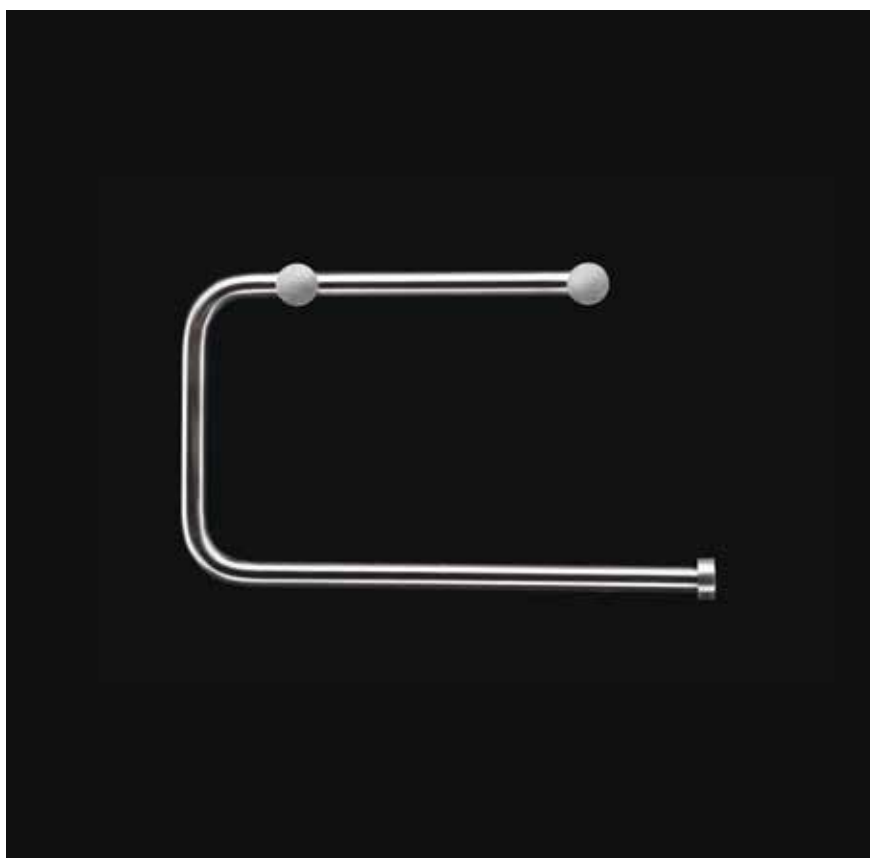

FEATURES / CARACTERÍSTICAS

Easy installation: double pitch screw.
Hidden attachments. Anti-corrosion.

Fácil instalación: tornillo de doble paso.
Fijaciones ocultas. Anticorrosión.

FINISHES / ACABADOS



Bright
Brillo



Matte
Mate





○
HOOK
COLGADOR

226 02 21
BRIGHT / BRILLO
226 03 21
MATTE / MATE

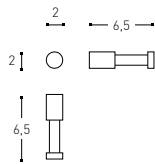

INCH 0.8x2.5x0.8



○
HOOK
COLGADOR

225 02 21
BRIGHT / BRILLO
225 03 21
MATTE / MATE

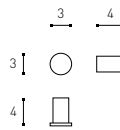

INCH 1.2x1.6x1.2



○△
FREE STANDING BRUSH-HOLDER
PORTACEPILLOS ENCIMERA

226 02 51
BRIGHT / BRILLO
226 03 51
MATTE / MATE

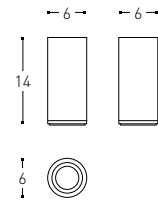

INCH 2.4x3.5x5.5



○△
BRUSH-HOLDER
PORTACEPILLOS

226 02 03
BRIGHT / BRILLO
226 03 03
MATTE / MATE

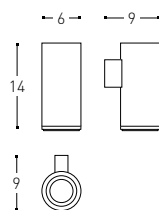

INCH 2.4x3.5x5.5



○△
FREE STANDING SOAP DISPENSER
DOSIFICADOR ENCIMERA

226 02 53
BRIGHT / BRILLO
226 03 53
MATTE / MATE

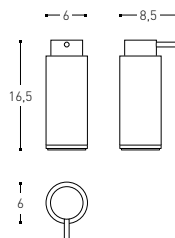

INCH 2.4x3.3x6.5



○△
SOAP DISPENSER
DOSIFICADOR

226 02 04
BRIGHT / BRILLO
226 03 04
MATTE / MATE

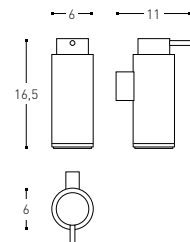

INCH 2.4x4.3x6.5



○ ◆
GLASS SHELF
ESTANTE VIDRIO

226 02 45
BRIGHT / BRILLO
226 03 45
MATTE / MATE

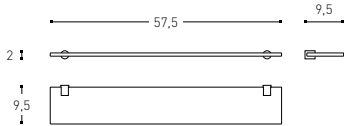

INCH 22.6x3.7x0.8



○
STAINLESS STEEL FLAT SHELF
ESTANTE INOX

226 02 46
BRIGHT / BRILLO
226 03 46
MATTE / MATE

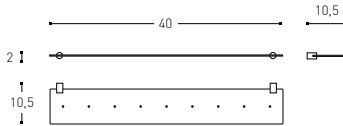

INCH 15.7/23.6x4.1x0.8



○
STAINLESS STEEL CORNER SHELF
ESTANTE RINCÓN INOX

226 02 43
BRIGHT / BRILLO
226 03 43
MATTE / MATE

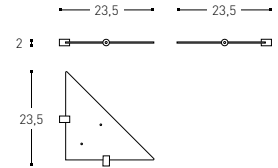

INCH 9.2x9.2x0.8



○
TOWEL RACK
TOALLERO

226 02 64
40 CM / INCH 15.5 BRIGHT / BRILLO
226 02 65
60 CM / INCH 23.4 BRIGHT / BRILLO
226 02 66
80 CM / INCH 31.3 BRIGHT / BRILLO
226 03 64
40 CM / INCH 15.5 MATTE / MATE
226 03 65
60 CM / INCH 23.4 MATTE / MATE
226 03 66
80 CM / INCH 31.3 MATTE / MATE

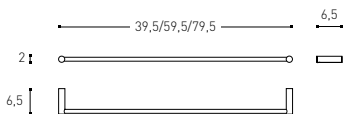

INCH 15.5/23.4/31.3x2.5x0.8



○
DOUBLE TOWEL RACK
TOALLERO DOBLE

226 02 61
BRIGHT / BRILLO
226 03 61
MATTE / MATE

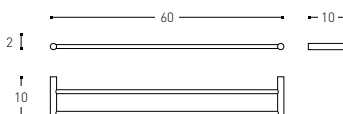

INCH 23.6x3.9x0.8



○
SWIVEL TOWEL RACK
TOALLERO GIRATORIO

226 02 74
BRIGHT / BRILLO
226 03 74
MATTE / MATE

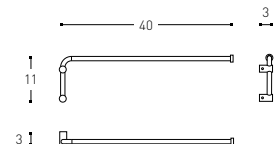

INCH 15.7x1.2x4.3





○
TOWEL RING
TOALLERO ARO

226 02 72
BRIGHT / BRILLO
226 03 72
MATTE / MATE

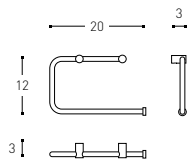

INCH 7.9x1.2x4.7



○
TOWEL RACK SHELF
TOALLERO ESTANTE

226 02 68
BRIGHT / BRILLO
226 03 68
MATTE / MATE

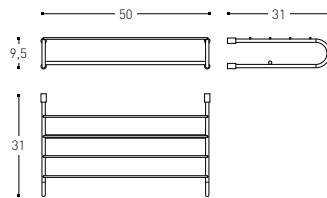

INCH 19.7x12.2x3.7



○
PAPER HOLDER WITH COVER
PORTAPAPEL CON TAPA

226 02 59
BRIGHT / BRILLO
226 03 59
MATTE / MATE

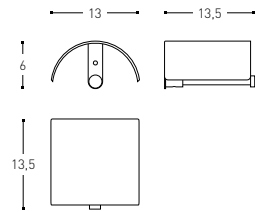

INCH 5.1x5.3x2.4



○
PAPER HOLDER WITH COVER
PORTAPAPEL CON TAPA

225 02 59
BRIGHT / BRILLO
225 03 59
MATTE / MATE

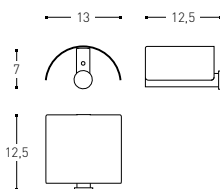

INCH 5.1x4.9x2.7



○
PAPER HOLDER WITHOUT COVER
PORTAPAPEL SIN TAPA

226 02 58
BRIGHT / BRILLO
226 03 58
MATTE / MATE

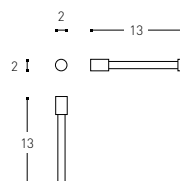

INCH 0.8x5.1x0.8



○
PAPER HOLDER WITHOUT COVER
PORTAPAPEL SIN TAPA

225 02 58
BRIGHT / BRILLO
225 03 58
MATTE / MATE

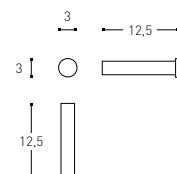

INCH 1.2x4.9x1.2



DOUBLE PAPER HOLDER WITHOUT COVER
PORTAPAPEL DOBLE SIN TAPA

226 02 57
BRIGHT / BRILLO
226 03 57
MATTE / MATE

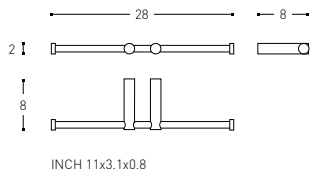

PAPER HOLDER WITHOUT COVER
PORTAPAPEL SIN TAPA

226 02 56
BRIGHT / BRILLO
226 03 56
MATTE / MATE

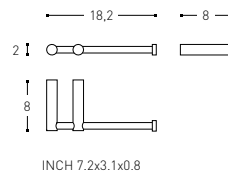

PAPER HOLDER/TOWEL RACK
PORTAPAPEL/TOALLERO

226 02 54
BRIGHT / BRILLO
226 03 54
MATTE / MATE

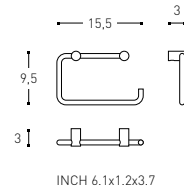

PAPER HOLDER / SWIVEL TOWEL RACK
PORTAPAPEL/TOALLERO GIRATORIO

226 02 73
BRIGHT / BRILLO
226 03 73
MATTE / MATE

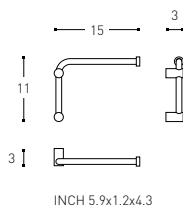

TOILET BRUSH FLOOR / WALL
ESCOBILLERO SUELO/PARED

249 98 00
NEGRO-MATE / BLACK-MATTE
249 96 00
NEGRO-BRILLO / BLACK-GLOSSY

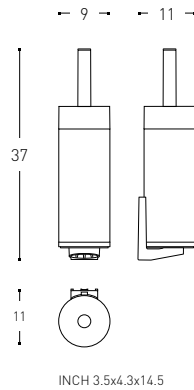

FREE STANDING TOILET BRUSH
ESCOBILLERO SUELO

226 02 01
BRIGHT / BRILLO
226 03 01
MATTE / MATE

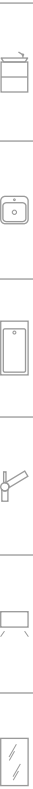
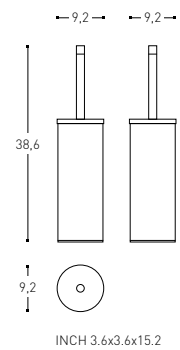



TOILET BRUSH
ESCOBILLERO

226 02 97
BRIGHT / BRILLO

226 03 97
MATTE / MATE

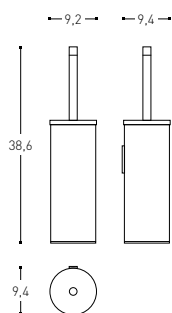

INCH 3.6x3.7x15.2



SET OF 2 SHELF HOLDERS
JUEGO 2 SOPORTES ESTANTE

226 02 80
BRIGHT / BRILLO

226 03 80
MATTE / MATE

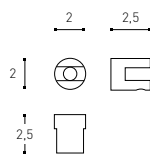

INCH 0.8x1x0.8

Spare parts | Recambios

DRYWALL ANCHOR
TACO PLADUR

3410636

SPARE PART OF / RECAMBIO DE
2250221, 2250232, 2250246, 2250258, 2250259, 2250261, 2250264, 2250271, 2250321,
2250332, 2250346, 2250358, 2250359, 2250361, 2250365, 2499600, 2499800

SCREW MOUNTING SET (M5/M6)
JUEGO BIS SUJECIÓN (M5/M6)

3309100

SPARE PART OF / RECAMBIO DE
2260243, 2260246, 2260343, 2260346, 2260221, 2260258, 2260268, 2260321, 2260358,
2260368, 2260259, 2260359, 2260254, 2260257, 2260261, 2260264, 2260265, 2260266,
2260272, 2260273, 2260274, 2260357, 2260361, 2260364, 2260365, 2260366, 2260372,
2260373, 2260374, 2660354

ROUND WALL MOUNTING SET
ACCESORIO SUJECIÓN PARED REDONDO

3410612

SPARE PART OF / RECAMBIO DE
2250221, 2250258, 2250321, 2250358

BASIC MOUNTING SET
ACCESORIO SUJECIÓN BÁSICO

3410018

SPARE PART OF / RECAMBIO DE
2260203, 2260204, 2260245, 2260280, 2260304, 2260345, 2260380, 2260303

WALL MOUNTING SET (1 SCREW)
ACCESORIO SUJECIÓN PARED (1 TORNILLO)

3308600

SPARE PART OF / RECAMBIO DE
2260254, 2260256, 2260257, 2260261, 2260264, 2260265, 2260266, 2260272, 2260273,
2260274, 2260354, 2260356, 2260357, 2260361, 2260364, 2260365, 2260366, 2260372,
2260373, 2260374

WALL MOUNTING SET
ACCESORIO SUJECIÓN PARED

3410044

SPARE PART OF / RECAMBIO DE
2260268

3410045

SPARE PART OF / RECAMBIO DE
2260368

PAPER HOLDER MOUNTING SET
ACCESORIO SUJECIÓN PORTAPAPEL

3410007

SPARE PART OF / RECAMBIO DE
2250259, 2250359

DISPENSER PUSH BUTTON + PUMP
PULSADOR + BOMBA DOSIFICADOR

3410113

SPARE PART OF / RECAMBIO DE
2260204, 2260253

3410115

SPARE PART OF / RECAMBIO DE
2260304, 2260353

DISPENSER PUMP
BOMBA DOSIFICADOR

3410682

SPARE PART OF / RECAMBIO DE
2260253, 2260353

SHELF
ESTANTE

3303130

SPARE PART OF / RECAMBIO DE
2260245, 2260345

TOILET BRUSH STICK WITH BRUSH
PALO ESCOBILLERO CON CEPILLO

3410093

GLOSSY BLACK / NEGRO BRILLO
SPARE PART OF / RECAMBIO DE
2499800

3410095

MATTE BLACK / NEGRO MATE
SPARE PART OF / RECAMBIO DE
2499800

3410747

GLOSSY STAINLESS STEEL / INOX BRILLO
SPARE PART OF / RECAMBIO DE
2260201, 2260297

3410748

MATTE STAINLESS STEEL / INOX MATE
SPARE PART OF / RECAMBIO DE
2260301, 2260397

TOILET BRUSH BRUSH
CEPILLO ESCOBILLERO

3410313

SPARE PART OF / RECAMBIO DE
2499600, 2499800

3410735

SPARE PART OF / RECAMBIO DE
2260201, 2260301, 2260297, 2260397

3501100

SPARE PART OF / RECAMBIO DE
2499600, 2499800



Minimalism

Design by **Cosmic Studio**







Maximum wellbeing in
the bathroom environment
with minimum elements.

El máximo bienestar
en el entorno del baño
con mínimos elementos.

Minimalism

Design by Cosmic Studio





Minimalism has successfully passed the high demanding tests of long last durability and resistance to extreme uses (static charge or impact testing) to assure long last durability of the product.

Toda la gama **Minimalism** ha superado con éxito exigentes tests de durabilidad y resistencia a usos extremos (cargas estáticas o test de impacto), para asegurar una larga vida al producto.

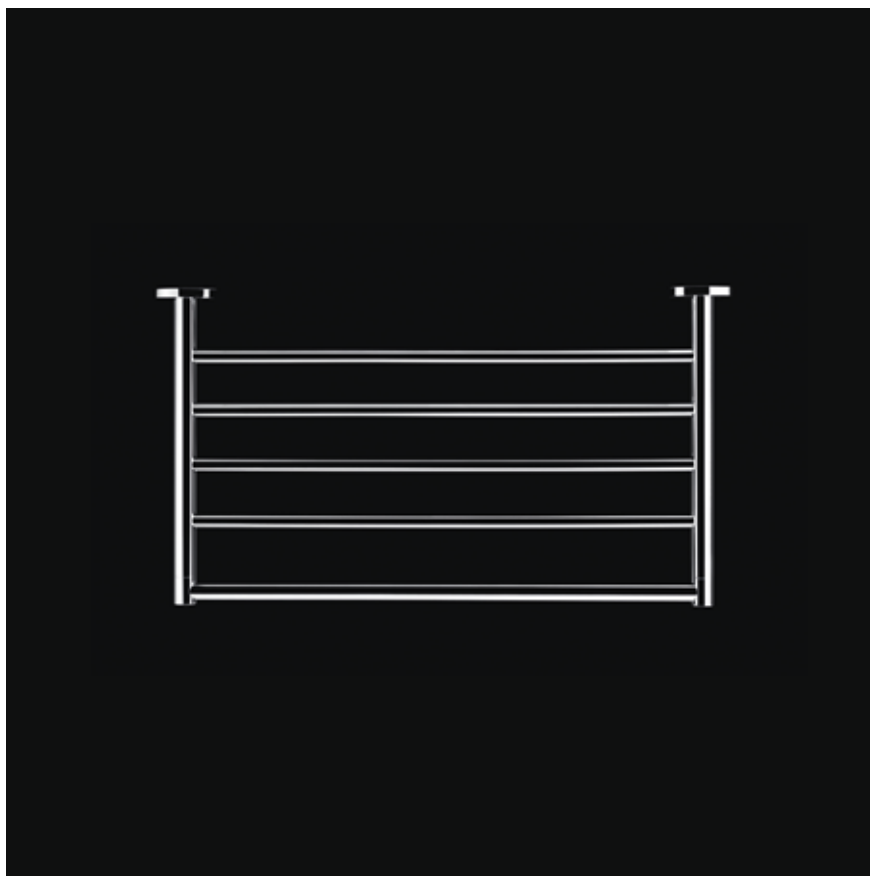

FEATURES / CARACTERÍSTICAS

Easy installation: double pitch screw.
Hidden attachments. Anti-corrosion.

Fácil instalación: tornillo de doble paso.
Fijaciones ocultas. Anticorrosión.



Minimalism

Design by **Cosmic Studio**



⊙
HOOK
COLGADOR

240 0121

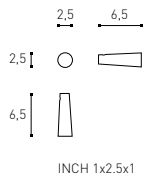

⊙◇
SOAP DISH
JABONERA

240 0132

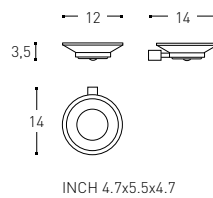

⊙△
FREE STANDING BRUSH-HOLDER
PORTACEPILLOS ENCIMERA

251 0153

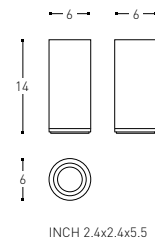

⊙△
BRUSH-HOLDER
PORTACEPILLOS

251 0154

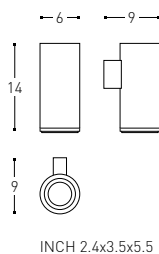

⊙△
FREE STANDING SOAP DISPENSER
DOSIFICADOR ENCIMERA

251 0104

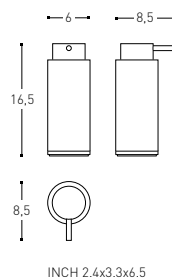

⊙△
SOAP DISPENSER
DOSIFICADOR

251 0105

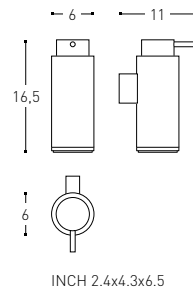



WALL MAGNIFYING MIRROR
ESPEJO DE AUMENTO PARED

240 0186

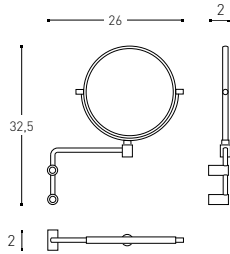

INCH 10.2x0.8x12.8



GLASS SHELF
ESTANTE VIDRIO

240 0145

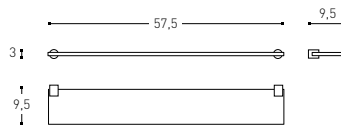

INCH 22.6x3.7x1.2



SHELF
ESTANTE

240 0146

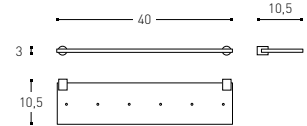

INCH 15.7x4.1x1.2



STAINLESS STEEL CORNER SHELF
ESTANTE RINCÓN INOX

240 0143

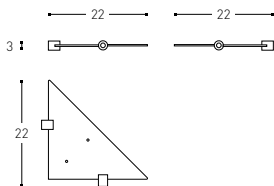

INCH 8.7x8.7x1.2



BASKET
CONTAINER

240 0149

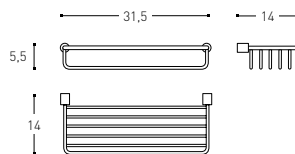

INCH 12.4x5.5x2.2



BASKET
CONTAINER

240 0148
41 CM / INCH 16.1
240 0188
51 CM / INCH 20.1

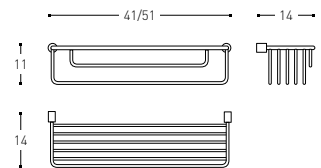

INCH 16.1/20.1x5.5x4.3



Minimalism

Design by **Cosmic Studio**



⊙
CORNER BASKET
CONTAINER RINCÓN

240 0150
5,5 CM / INCH 2.2
240 0189
9 CM / INCH 3.5

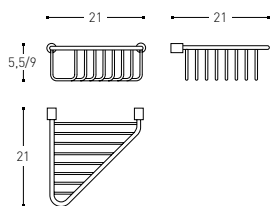

INCH 8.3x8.3x2.2/3.5



⊙
TOWEL RACK
TOALLERO

240 0164
41,5 CM / INCH 16.3
240 0165
61,5 CM / INCH 24.2
240 0166
81,5 CM / INCH 32.1

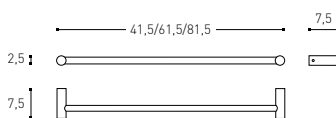

INCH 16.3/24.2/32.1x2.9x1



⊙
DOUBLE TOWEL RACK
TOALLERO DOBLE

240 0161

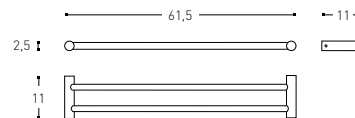

INCH 24.2x4.3x1



⊙
SWIVEL DOUBLE TOWEL RACK
TOALLERO DOBLE GIRATORIO

240 0175

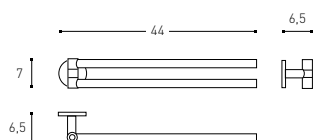

INCH 18.3x2.6x2.4



⊙
TOWEL RING
TOALLERO ARO

240 0171
16x5x17 CM / INCH 6.3x2x6.7
240 0172
21x5x22 CM / INCH 8.3x2x8.7

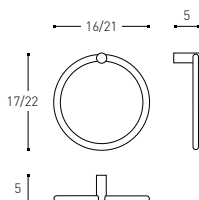

INCH 6.3/8.3x2x6.7/8.7



⊙
TOWEL RACK SHELF
TOALLERO ESTANTE

240 0168

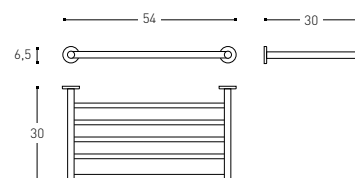

INCH 21.2x11.8x2.5



⊙
PAPER HOLDER WITH COVER
PORTAPAPEL CON TAPA

240 0159



⊙
PAPER HOLDER WITHOUT COVER
PORTAPAPEL SIN TAPA

240 0158



⊙
SET OF 2 SHELF HOLDERS
JUEGO 2 SOPORTES ESTANTE

240 0180

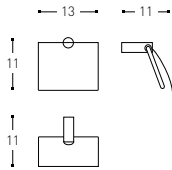

INCH 5.1x4.3x4.3

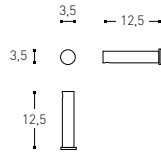

INCH 1.4x4.9x1.4

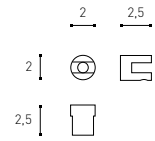

INCH 0.8x1x0.8



⊙◇
TOILET BRUSH
ESCOBILLERO

240 0100

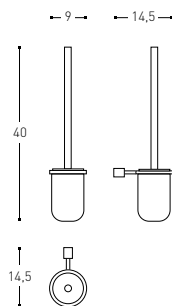

INCH 3.5x5.7x15.7



⊙○△
FREE-STANDING OR WALL TOILET BRUSH
ESCOBILLERO SUELO/PARED

251 0100

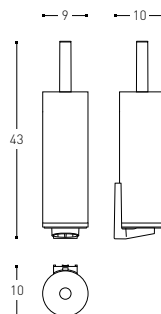

INCH 3.5x3.9x16.9



Minimalism

Design by **Cosmic Studio**

DRYWALL ANCHOR
TACO PLADUR

3410636

SPARE PART OF / RECAMBIO DE
2400100, 2400121, 2400132, 2400143, 2400145, 2400146, 2400148, 2400149, 2400150,
2400158, 2400159, 2400161, 2400164, 2400165, 2400166, 2400168, 2400171, 2400172,
2400175, 2400186, 2400188, 2400189, 2510105, 2510100

SCREW MOUNTING SET (M5/M6)
JUEGO BIS SUJECIÓN (M5/M6)

3309100

SPARE PART OF / RECAMBIO DE
2400148, 2400149, 2400100, 2400132, 2400150, 2400188, 2400189, 2400121, 2400168,
2400175

WALL MOUNTING SET (1 SCREW)
ACCESORIO SUJECIÓN PARED (1 TORNILLO)

3308600

SPARE PART OF / RECAMBIO DE
2400121, 2400171, 2400172, 2400186, 2400158, 2400164, 2400165, 2400166,

BASIC MOUNTING SET
ACCESORIO SUJECIÓN BÁSICO

3410018

SPARE PART OF / RECAMBIO DE
2400145, 2400180

ROUND WALL MOUNTING SET
ACCESORIO SUJECIÓN PARED REDONDO

3307600

SPARE PART OF / RECAMBIO DE
2400168

WALL MOUNTING SET
ACCESORIO SUJECIÓN PARED

3410048

SPARE PART OF / RECAMBIO DE
2400175

ROUND WALL MOUNTING SET
ACCESORIO SUJECIÓN PARED REDONDO

3410612

SPARE PART OF / RECAMBIO DE
2400143, 2400146

WALL MOUNTING SET
ACCESORIO SUJECIÓN PARED

3410614

SPARE PART OF / RECAMBIO DE
2400168, 2400175

CONTAINER MOUNTING SET
ACCESORIO SUJECIÓN CONTAINER

3410064

SPARE PART OF / RECAMBIO DE
2400148, 2400149, 2400150, 2400188, 2400189

WALL MOUNTING SET TOWEL RACK SHELF
SOPORTE PARED TOALLERO ESTANTE

3410669

SPARE PART OF / RECAMBIO DE
2400175

SOAP DISH
JABONERA

3306000

SPARE PART OF / RECAMBIO DE
2400132

DISPENSER PUSH BUTTON + PUMP
PULSADOR + BOMBA DOSIFICADOR

3409020

SPARE PART OF / RECAMBIO DE
2510104, 2510105

DISPENSER PUMP
BOMBA DOSIFICADOR

3410682

SPARE PART OF / RECAMBIO DE
2510104, 2510105

SHELF
ESTANTE

3303130

SPARE PART OF / RECAMBIO DE
2400145

TOILET BRUSH GLASS
VASO ESCOBILLERO

3308300

SPARE PART OF / RECAMBIO DE
2400100

TOILET BRUSH STICK WITH BRUSH
PALO ESCOBILLERO CON CEPILLO

3400401

SPARE PART OF / RECAMBIO DE
2400100

3409017

SPARE PART OF / RECAMBIO DE
2510100

TOILET BRUSH BRUSH
CEPILLO ESCOBILLERO

3410313

SPARE PART OF / RECAMBIO DE
2510100, 2400100

3501100

SPARE PART OF / RECAMBIO DE
2510100, 2400100



Project

Design by **Cosmic Studio**









Project has successfully passed the high demanding tests of long last durability and resistance to extreme uses (static charge or impact testing) to assure long last durability of the product.

Toda la gama **Project** ha superado con éxito exigentes tests de durabilidad y resistencia a usos extremos (cargas estáticas o test de impacto), para asegurar una larga vida al producto.

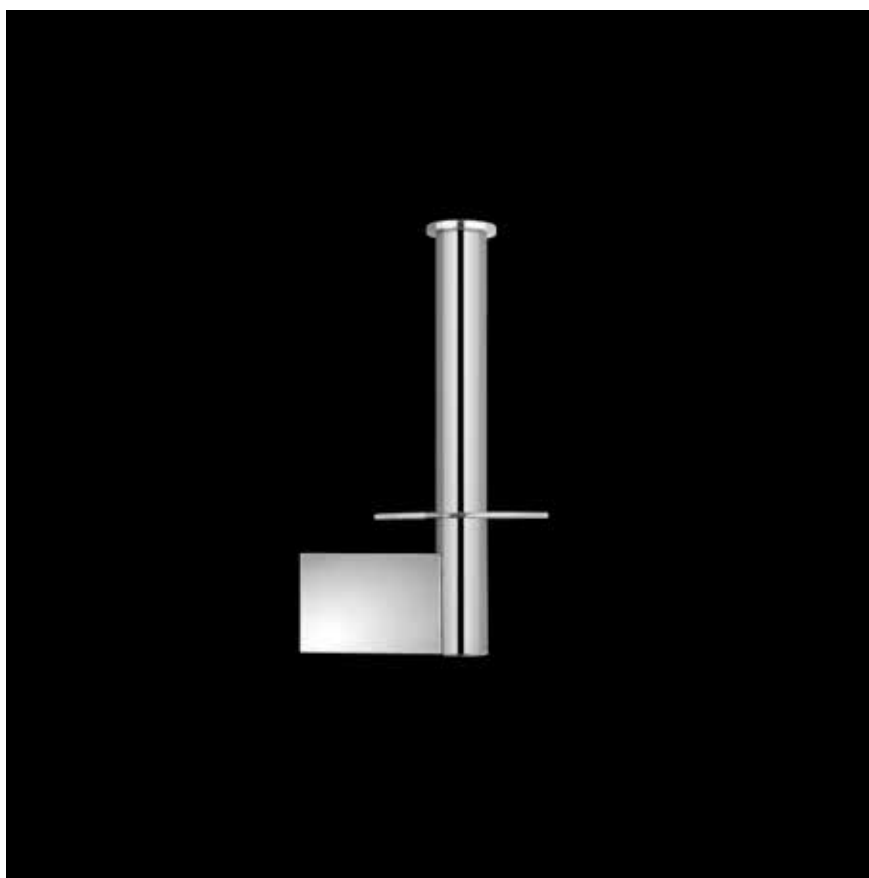

FEATURES / CARACTERÍSTICAS

Easy installation: double pitch screw.
Hidden attachments. Support bars:
reinforced design for disabled people: 150kg.
Anti-corrosion.

Fácil instalación: tornillo de doble paso.
Fijaciones ocultas. Barras de apoyo: diseño
reforzado para minusvalías: 150 kgs.
Anticorrosión.

FINISHES / ACABADOS



Chrome
Cromo



Chrome-White
Cromo-Blanco



Chrome-Black
Cromo-Negro





⊙
HOOK
COLGADOR

251 01 21

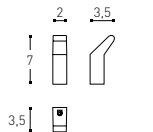

INCH 0.8x1.4x2.7



⊙△
FREE STANDING SOAP DISH
JABONERA ENCIMERA

251 51 34
CHROME-WHITE / CROMO-BLANCO
251 61 34
CHROME-BLACK / CROMO-NEGRO

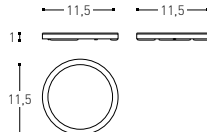

INCH 4.5x4.5x0.4



⊙△
SOAP DISH
JABONERA

251 51 32
CHROME-WHITE / CROMO-BLANCO
251 61 32
CHROME-BLACK / CROMO-NEGRO

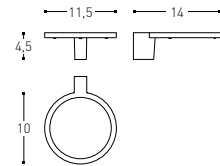

INCH 4.5x5.5x1.8



⊙△
FREE STANDING BRUSH-HOLDER
PORTACEPILLOS ENCIMERA

251 01 53

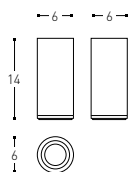

INCH 2.4x2.4x5.5



⊙△
BRUSH-HOLDER
PORTACEPILLOS

251 01 54

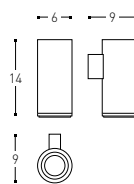

INCH 2.4x3.2x5.5



⊙△
FREE STANDING SOAP DISPENSER
DOSIFICADOR ENCIMERA

251 01 04

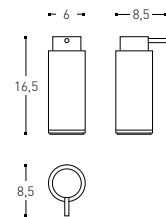

INCH 2.4x3.3x6.5



⊙△
SOAP DISPENSER
DOSIFICADOR

2510105

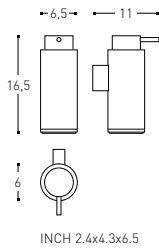

⊙△◇
FREE STANDING MAGNIFYING MIRROR
ESPEJO AUMENTO ENCIMERA

2515183
(x3) CHROME-WHITE / CROMO-BLANCO
2516183
(x3) CHROME-BLACK / CROMO-NEGRO

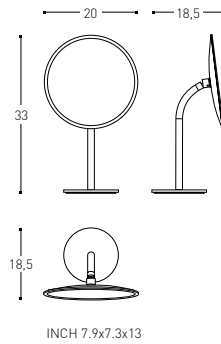

⊙△◇
WALL MAGNIFYING MIRROR
ESPEJO DE AUMENTO PARED

2515185
(x3) CHROME-WHITE / CROMO-BLANCO
2516185
(x3) CHROME-BLACK / CROMO-NEGRO

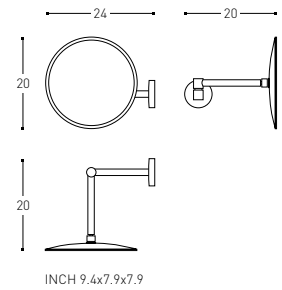

⊙◇
GLASS SHELF
ESTANTE VIDRIO

2510144
40 CM / INCH 15.7
2510145
60 CM / INCH 23.6

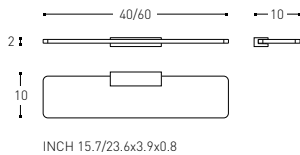

⊙△
BASKET
CONTAINER

2515149
CHROME-WHITE / CROMO-BLANCO
2516149
CHROME-BLACK / CROMO-NEGRO

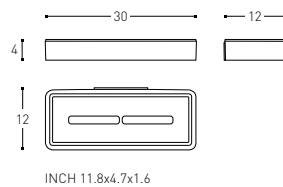

⊙△
CORNER BASKET
CONTAINER RINCÓN

2515150
CHROME-WHITE / CROMO-BLANCO
2516150
CHROME-BLACK / CROMO-NEGRO

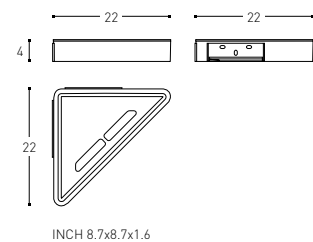



●
TOWEL RACK
TOALLERO

251 01 62

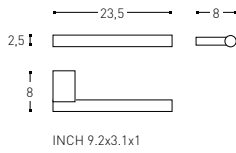

●
TOWEL RACK
TOALLERO

251 01 64
40 CM / INCH 15.7
251 01 65
60 CM / INCH 23.6
251 01 66
80 CM / INCH 31.5

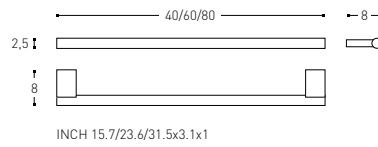

●
SWIVEL DOUBLE TOWEL RACK
TOALLERO DOBLE GIRATORIO

251 01 75

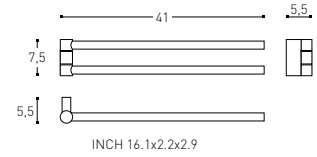

●
TOWEL RING
TOALLERO ARO

251 01 71
15 CM / INCH 5.9
251 01 72
20 CM / INCH 7.9

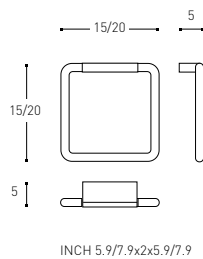

●
TOWEL RING
TOALLERO ARO

251 01 82

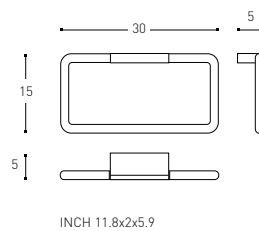

●
TOWEL RACK SHELF
TOALLERO ESTANTE

251 01 68

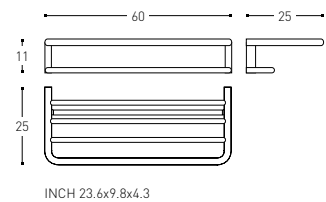



⊙
FREE STANDING TOWEL RACK
 TOALLERO DE PIE

251 01 67

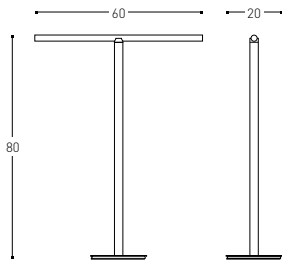

INCH 23.6x7.9x31.5



⊙
GRAB BAR
 ASA BAÑERA

251 01 24
 40 CM / INCH 15.7
251 01 25
 60 CM / INCH 23.6
251 01 98
 80 CM / INCH 31.5
251 01 99
 100 CM / INCH 39.4

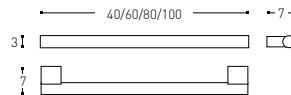

INCH 15.7/23.6/31.5/39.4x2.7x1.2



⊙
90° ANGLE BAR GRAB
 ASA BAÑERA ANGULO 90°

251 01 36

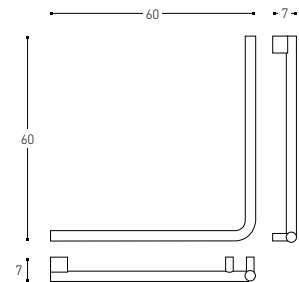

INCH 23.6x2.7x23.6



⊙△
PAPER HOLDER WITH COVER
 PORTAPEPEL CON TAPA

251 01 59

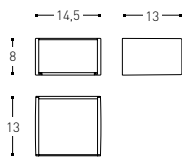

INCH 5.7x5.1x3.1



⊙
PAPER HOLDER WITHOUT COVER
 PORTAPEPEL SIN TAPA

251 01 58

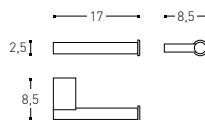

INCH 6.7x3.3x1



⊙
DOUBLE PAPER HOLDER WITHOUT COVER
 PORTAPEPEL DOBLE SIN TAPA

251 01 57

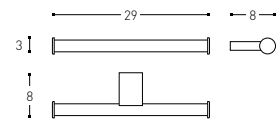

INCH 11.4x3.1x1.2





VERTICAL PAPER HOLDER
PORTAPEPEL VERTICAL

2510196

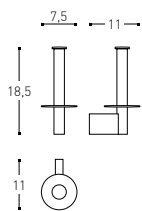

INCH 2.9x4.3x7.3



FREE-STANDING OR WALL TOILET BRUSH
ESCOBILLERO SUELO/PARED

2510100

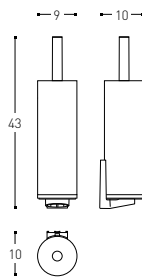

INCH 3.5x3.9x16.9



FREE STANDING TOILET BRUSH/PAPER HOLDER
ESCOBILLERO/PORTAPEPEL SUELO

2510197

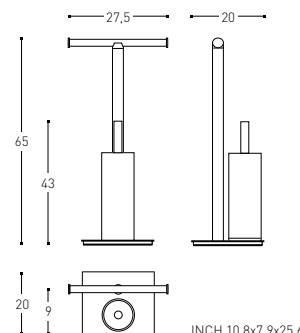

INCH 10.8x7.9x25.6

Spare parts | Recambios

DRYWALL ANCHOR
TACO PLADUR

3410636

SPARE PART OF / RECAMBIO DE
2515132, 2515149, 2515150, 2515185, 2516132, 2516149, 2516150, 2516185, 2510162, 2510105,
2510151, 2510121, 2510164, 2510165, 2510166, 2510175, 2510172, 2510171, 2510182, 2510168,
2510159, 2510157, 2510196, 2510100

3410637

SPARE PART OF / RECAMBIO DE
2510124, 2510125, 2510136, 2510198, 2510199,

SCREW MOUNTING SET (M5/M6)
JUEGO BIS SUJECIÓN (M5/M6)

3309100

SPARE PART OF / RECAMBIO DE
2510175, 2510196

WALL MOUNTING SET ACCESORIO SUJECIÓN PARED
3410121

SPARE PART OF / RECAMBIO DE
2510121, 2510157, 2510158, 2510162, 2510164, 2510165, 2510166, 2515132, 2516132

TRIPLE MOUNTING SET
ACCESORIO SUJECIÓN TRIPLE

3410122

SPARE PART OF / RECAMBIO DE
2510168, 2510175

SUPPORT BAR WALL MOUNTING SET
ACCESORIO SUJECIÓN BARRA DE APOYO

3410123

SPARE PART OF / RECAMBIO DE
2510124, 2510125, 2510136, 2510198, 2510199

90° ANGLE SUPPORT BAR WALL MOUNTING SET
ACCESORIO SUJECIÓN BARRA DE APOYO 90°

3410124

SPARE PART OF / RECAMBIO DE
2510136

TRIPLE PLASTIC MOUNTING SET
ACCESORIO SUJECIÓN PLÁSTICO TRIPLE

3410125

SPARE PART OF / RECAMBIO DE
2510171, 2510172, 2510182

SHELF MOUNTING SET
ACCESORIO SUJECIÓN ESTANTE

3410302

SPARE PART OF / RECAMBIO DE
2510144, 2510145

DISPENSER PUSH BUTTON + PUMP
PULSADOR + BOMBA DOSIFICADOR

3409020

SPARE PART OF / RECAMBIO DE
2510104, 2510105

DISPENSER PUMP
BOMBA DOSIFICADOR

3410682

SPARE PART OF / RECAMBIO DE
2510104, 2510105

GLASS MIRROR
LUNA ESPEJO

3410473

SPARE PART OF / RECAMBIO DE
2515183, 2515185

3410472

SPARE PART OF / RECAMBIO DE
2510185, 2516183

SHELF
ESTANTE

3410091

SPARE PART OF / RECAMBIO DE
2510144

3410088

SPARE PART OF / RECAMBIO DE
2510145

CROSS AXIS PAPER HOLDER
EJE PORTAPAPEL

3419020

SPARE PART OF / RECAMBIO DE
2510159

TOILET BRUSH STICK WITH BRUSH
PALO ESCOBILLERO CON CEPILLO

3409017

SPARE PART OF / RECAMBIO DE
2510100, 2510197

TOILET BRUSH BRUSH
CEPILLO ESCOBILLERO

3410313

SPARE PART OF / RECAMBIO DE
2510100, 2510197

3501100

SPARE PART OF / RECAMBIO DE
2510100, 2510197



The Grid

Design by Ricard Ferrer







Parallel lines which frame
objects specifically designed
for an architecturally
engineered bathroom.

Líneas paralelas que
enmarcan objetos dedicados
a un baño concebido desde
la óptica arquitectónica.



The Grid

Design by Ricard Ferrer



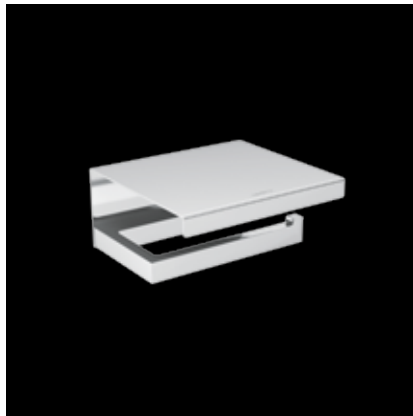
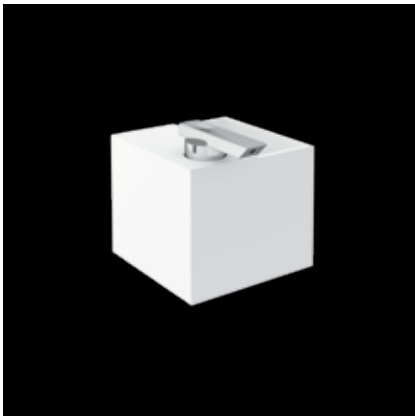

FEATURES / CARACTERÍSTICAS

Hidden attachments. Anti-Corrosion. Lead free matte paint. Shelves & glasses made of acrylic glass.

Fijaciones ocultas. Anticorrosión. Pintura mate libre de plomo. Estantes y vasos fabricados en cristal acrílico.

Accessories with a ground-breaking, functional design. A commitment to innovation and modernity.

Accesorios con un diseño rompedor y funcional. Una apuesta por la innovación y la modernidad.

The Grid has successfully passed the high demanding tests of long last durability and resistance to extreme uses (static charge or impact testing) to assure long last durability of the product.

Toda la gama **The Grid** ha superado con éxito exigentes tests de durabilidad y resistencia a usos extremos (cargas estáticas o test de impacto), para asegurar una larga vida al producto.

STRUCTURE FINISHES / ACABADOS ESTRUCTURA



Chrome
Cromo

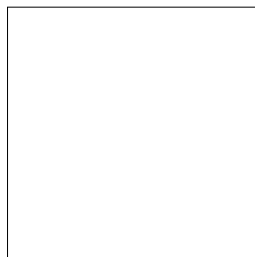

Matte white
Blanco mate

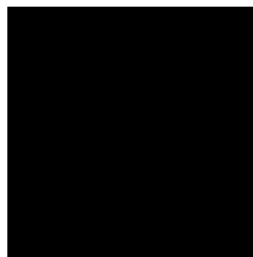

Matte black
Negro mate

SHELF/FURNITURE FINISHES / ACABADOS ESTANTES/MUEBLES

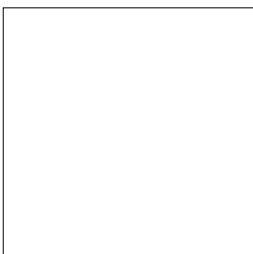

Matte white
Blanco mate



Clear oak
Roble claro



Dark oak
Roble oscuro

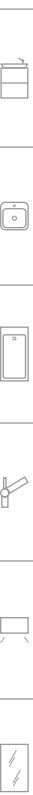

The Grid

Design by Ricard Ferrer



⊙
HOOK
COLGADOR

268 01 21
CHROME / CROMO
268 36 21
MATTE BLACK / NEGRO MATE
268 65 21
MATTE WHITE / BLANCO MATE



INCH 0.6x1.2x4.3



⊙ △
FREE-STANDING SOAP DISPENSER + BRUSH-HOLDER
DOSIFICADOR + PORTACEPILLOS ENCIMERA

268 01 04
CHROME / CROMO
268 36 04
MATTE BLACK / NEGRO MATE
268 65 04
MATTE WHITE / BLANCO MATE

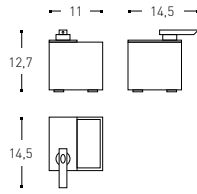

INCH 4.3x5.7x5



⊙ △
SOAP DISPENSER + BRUSH-HOLDER
DOSIFICADOR + PORTACEPILLOS

268 01 05
CHROME / CROMO
268 36 05
MATTE BLACK / NEGRO MATE
268 65 05
MATTE WHITE / BLANCO MATE

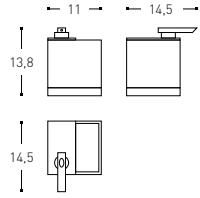

INCH 4.3x5.7x5.4



△
DOUBLE BRUSH-HOLDER
PORTACEPILLOS DOBLE

268 05 53

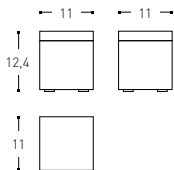

INCH 4.3x4.3x4.9



⊙ △
TOWEL RACK WITH SHELF / BASKET
TOALLERO CON REPISA / CONTAINER

268 01 63
CHROME / CROMO
268 36 63
MATTE BLACK / NEGRO MATE
268 65 63
MATTE WHITE / BLANCO MATE

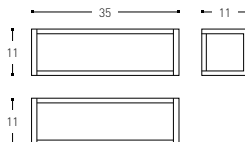

INCH 13.8x4.3x4.3

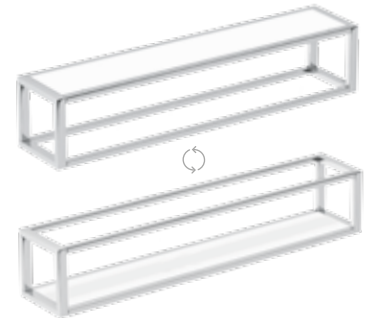

⊙ △
TOWEL RACK WITH SHELF / BASKET
TOALLERO CON REPISA / CONTAINER

268 01 65
CHROME / CROMO
268 36 65
MATTE BLACK / NEGRO MATE
268 65 65
MATTE WHITE / BLANCO MATE

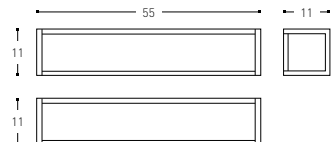

INCH 21.7x4.3x4.3



⊙
TOWEL RING
TOALLERO ARO

268 0171
CHROME / CROMO
268 36 71
MATTE BLACK / NEGRO MATE
268 65 71
MATTE WHITE / BLANCO MATE

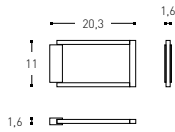

INCH 9.2x0.6x4.3



⊙
SWIVEL TOWEL RACK
TOALLERO GIRATORIO

268 0174
CHROME / CROMO
268 36 74
MATTE BLACK / NEGRO MATE
268 65 74
MATTE WHITE / BLANCO MATE

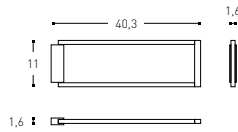

INCH 15.9x0.6x4.3



⊙⚠
TOWEL RACK SHELF
TOALLERO ESTANTE

268 0168
CHROME / CROMO
268 36 68
MATTE BLACK / NEGRO MATE
268 65 68
MATTE WHITE / BLANCO MATE

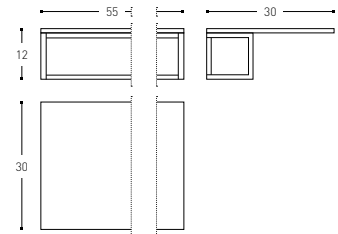

INCH 21.7x11.8x4.7

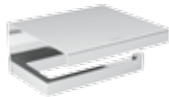

⊙
PAPER HOLDER WITH COVER
PORTAPAPEL CON TAPA

268 0159
CHROME / CROMO
268 36 59
MATTE BLACK / NEGRO MATE
268 65 59
MATTE WHITE / BLANCO MATE

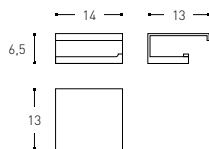

INCH 5.5x5.1x2.6



⊙
PAPER HOLDER WITHOUT COVER
PORTAPAPEL SIN TAPA

268 0158
CHROME / CROMO
268 36 58
MATTE BLACK / NEGRO MATE
268 65 58
MATTE WHITE / BLANCO MATE

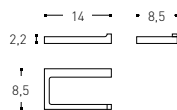

INCH 5.5x3.3x0.9



⊙⚠
FREE-STANDING OR WALL TOILET BRUSH
ESCOBILLERO SUELO/PARED

268 0100
CHROME / CROMO
268 36 00
MATTE BLACK / NEGRO MATE
268 65 00
MATTE WHITE / BLANCO MATE

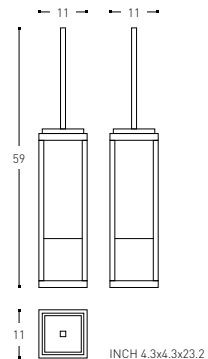

INCH 4.3x4.3x23.2



The Grid

Design by Ricard Ferrer



TOILET BRUSH
ESCOBILLERO

- 268 01 01**
CHROME / CROMO
- 268 36 01**
MATTE BLACK / NEGRO MATE
- 268 65 01**
MATTE WHITE / BLANCO MATE

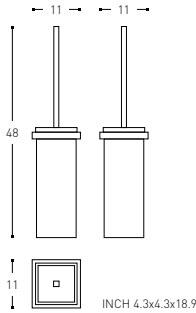

PORTABLE TOILET BRUSH + PAPER HOLDER + WASTE BIN
PORTÁTIL ESCOBILLERO + PORTAPEPEL + PAPELERA

- 768 00 05 180 01 265**
CHROME-MATTE WHITE / CROMO-BLANCO MATE
- 768 00 05 180 36 265**
MATTE BLACK-MATTE WHITE / NEGRO MATE-BLANCO MATE
- 768 00 05 180 65 265**
MATTE WHITE-MATTE WHITE / BLANCO MATE-BLANCO MATE

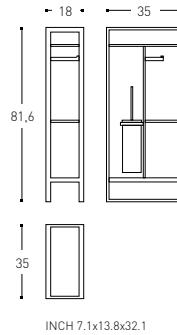

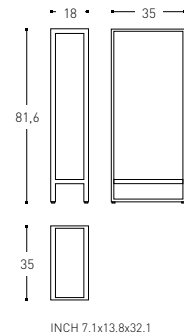

FREE STANDING TOWEL RACK
TOALLERO DE PIE

- 768 00 05 170 01 194**
CHROME-CLEAR OAK / CROMO-ROBLE CLARO
- 768 00 05 170 01 195**
CHROME-DARK OAK / CROMO-ROBLE OSCURO
- 768 00 05 170 01 265**
CHROME-MATTE WHITE / CROMO-BLANCO MATE
- 768 00 05 170 36 194**
MATTE BLACK-CLEAR OAK / NEGRO MATE-ROBLE CLARO
- 768 00 05 170 36 195**
MATTE BLACK-DARK OAK / NEGRO MATE-ROBLE OSCURO
- 768 00 05 170 36 265**
MATTE BLACK-MATTE WHITE / NEGRO MATE-BLANCO MATE
- 768 00 05 170 65 194**
MATTE WHITE-CLEAR OAK / BLANCO MATE-ROBLE CLARO
- 768 00 05 170 65 195**
MATTE WHITE-DARK OAK / BLANCO MATE-ROBLE OSCURO
- 768 00 05 170 65 265**
MATTE WHITE-MATTE WHITE / BLANCO MATE-BLANCO MATE





○◻◇
STOOL
TABURETE

-  **768 00 06 160 01 194**
CHROME-CLEAR OAK / CROMO-ROBLE CLARO
-  **768 00 06 160 01 195**
CHROME-DARK OAK / CROMO-ROBLE OSCURO
-  **768 00 06 160 01 265**
CHROME-MATTE WHITE / CROMO-BLANCO MATE
-  **768 00 06 160 36 194**
MATTE BLACK-CLEAR OAK / NEGRO MATE-ROBLE CLARO
-  **768 00 06 160 36 195**
MATTE BLACK-DARK OAK / NEGRO MATE-ROBLE OSCURO
-  **768 00 06 160 36 265**
MATTE BLACK-MATTE WHITE / NEGRO MATE-BLANCO MATE
-  **768 00 06 160 65 194**
MATTE WHITE-CLEAR OAK / BLANCO MATE-ROBLE CLARO
-  **768 00 06 160 65 195**
MATTE WHITE-DARK OAK / BLANCO MATE-ROBLE OSCURO
-  **768 00 06 160 65 265**
MATTE WHITE-MATTE WHITE / BLANCO MATE-BLANCO MATE

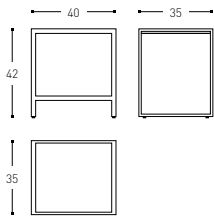

INCH 15.8x13.8x16.5



The Grid

Design by Ricard Ferrer

DRYWALL ANCHOR UX-R Ø6X35MM
TACO PLADUR UX-R Ø6X35MM

3410636

SPARE PART OF / RECAMBIO DE

WALL FIXATION SET SWIVEL TOWEL RACK
ACCESORIO SUJECIÓN PARED TOALLERO GIRATORIO

3410733

SPARE PART OF / RECAMBIO DE
2680121, 2680171, 2680174, 2683621, 2683671, 2683674, 2686521, 2686571, 2686574

WALL MOUNTING SET FOR
ACCESORIO SUJECIÓN PARED

3410732

SPARE PART OF / RECAMBIO DE
2680104, 2680105, 2683604, 2683605, 2686504, 2686505

CONTAINER MOUNTING SET
ACCESORIO SUJECIÓN CONTAINER

3410734

SPARE PART OF / RECAMBIO DE
2680163, 2680165, 2680168, 2683663, 2683665, 2683668, 2686563, 2686565, 2686568

PAPER HOLDER MOUNTING SET
ACCESORIO SUJECIÓN PORTAPEPEL

3410730

SPARE PART OF / RECAMBIO DE
2680158, 2680159, 2683658, 2683659, 2686558, 2686559

TOILET BRUSH FIXATION SET
ACCESORIO SUJECIÓN ESCOBILLERO

3410731

SPARE PART OF / RECAMBIO DE
2680100, 2680101, 2683600, 2683601, 2686500, 2686501

DISPENSER PUSH BUTTON + PUMP
PULSADOR + BOMBA DOSIFICADOR

3410739

SPARE PART OF / RECAMBIO DE
2680104, 2680105

3410740

SPARE PART OF / RECAMBIO DE
2683604, 2683605

3410741

SPARE PART OF / RECAMBIO DE
2686504, 2686505

DISPENSER PUMP
BOMBA DOSIFICADOR

3410682

SPARE PART OF / RECAMBIO DE
2680104, 2680105, 2683604, 2683605, 2686504, 2686505

FLANGE (X2)
EMBELLECEDOR (X2)

3410742

SPARE PART OF / RECAMBIO DE
2680163, 2680165, 2680168

3410743

SPARE PART OF / RECAMBIO DE
2683663, 2683665, 2683668

3410744

SPARE PART OF / RECAMBIO DE
2686563, 2686565, 2686568

SHELF 35CM
ESTANTE BLANCO MATE 35CM

3410745

SPARE PART OF / RECAMBIO DE
2680163, 2683663, 2686563

3410746

SPARE PART OF / RECAMBIO DE
2680165, 2683665, 2686565

TOILET BRUSH STICK WITH BRUSH + COVER
PALO ESCOBILLERO CON CEPILLO + TAPA

3410736

SPARE PART OF / RECAMBIO DE
2680100, 2680101

3410737

SPARE PART OF / RECAMBIO DE
2683600, 2683601

3410738

SPARE PART OF / RECAMBIO DE
2686500, 2686501

TOILET BRUSH BRUSH
CEPILLO ESCOBILLERO

3410735

SPARE PART OF / RECAMBIO DE
2680100, 2680101, 2683600, 2683601, 2686500, 2686501



Working

Design by **Cosmic Studio**









Based on pure function,
without ostentation.
Simple forms with an
extremely elegant expression.

Basada en la función pura,
sin más pretensiones.
Formas simples con un gesto
extremadamente elegante.







Working has successfully passed the high demanding tests of long last durability and resistance to extreme uses (static charge or impact testing) to assure long last durability of the product.

Toda la gama **Working** ha superado con éxito exigentes tests de durabilidad y resistencia a usos extremos (cargas estáticas o test de impacto), para asegurar una larga vida al producto.

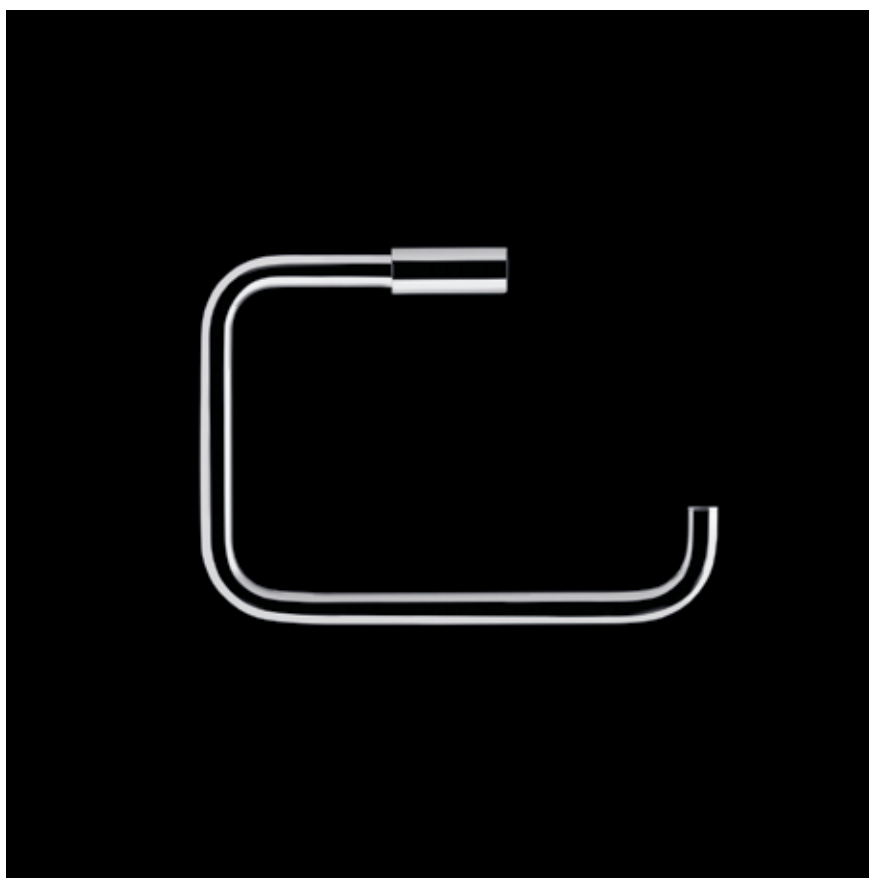

FEATURES / CARACTERÍSTICAS

Easy installation: double pitch screw.
Hidden attachments. Anti-corrosion.

Fácil instalación: tornillo de doble paso.
Fijaciones ocultas. Anticorrosión.





⊙
HOOK
COLGADOR

238 0121

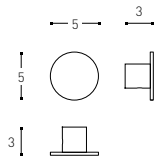

INCH 2x1.2x2



⊙
HOOK
PORTAGUANTES

238 0120

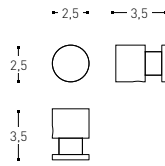

INCH 1x1.4x1



⊙△
FREE STANDING BRUSH-HOLDER
PORTACEPILLOS ENCIMERA

251 0153

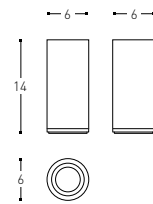

INCH 2.4x2.4x5.5



⊙△
BRUSH-HOLDER
PORTACEPILLOS

251 0154

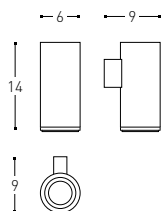

INCH 2.4x3.5x5.5



⊙
FREE STANDING SOAP DISPENSER
DOSIFICADOR ENCIMERA

251 0104

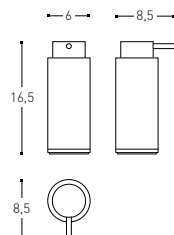

INCH 2.4x3.3x6.5



⊙
SOAP DISPENSER
DOSIFICADOR

251 0105

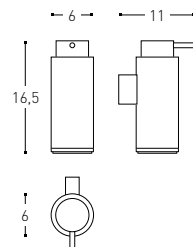

INCH 2.4x4.3x6.5



◆
GLASS SHELF
ESTANTE VIDRIO

238 0145

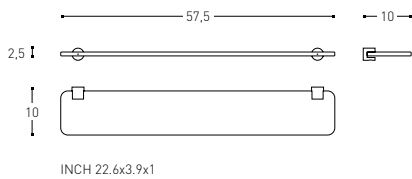

●
BASKET
CONTAINER

238 0186

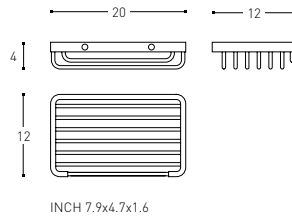

●
BASKET
CONTAINER

238 0149

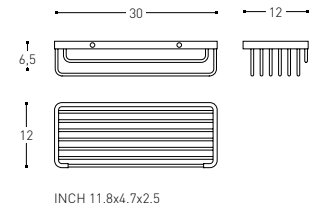

●
BASKET
CONTAINER

238 0148
40 CM / INCH 15.7
238 0188
50 CM / INCH 19.7

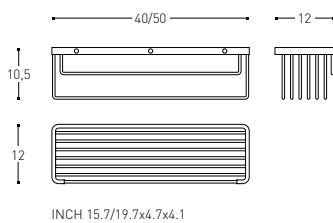

●
CORNER BASKET
CONTAINER RINCÓN

238 0150

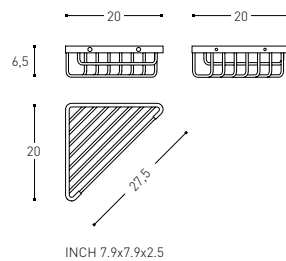

●
TOWEL RACK
TOALLERO

238 0164
40 CM / INCH 15.7
238 0165
60 CM / INCH 23.6
238 0166
80 CM / INCH 31.5

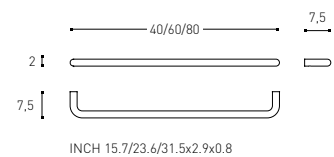



⊙
SWIVEL TOWEL RACK
TOALLERO GIRATORIO

238 0174

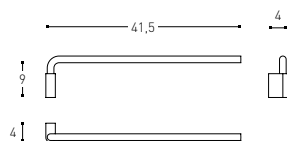

INCH 16.3x1.6x3.5



⊙
TOWEL RACK SHELF
TOALLERO ESTANTE

238 0168

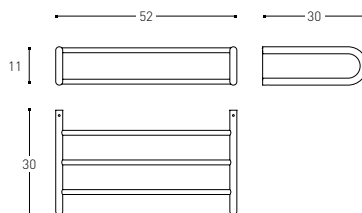

INCH 20.5x11.8x4.3



⊙
TOWEL RING
TOALLERO ARO

238 0171
12.5 CM / INCH 4.9

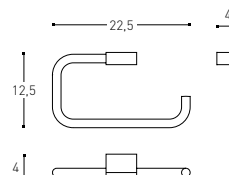

INCH 8.8x1.6x4.9



⊙○
PAPER HOLDER WITH COVER
PORTAPEPEL CON TAPA

238 0159

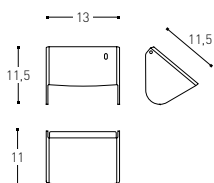

INCH 5.1x4.5x4.5



⊙
PAPER HOLDER WITHOUT COVER
PORTAPEPEL SIN TAPA

238 0158

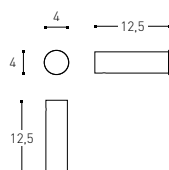

INCH 1.6x4.9x1.6



⊙◇
FREE STANDING TOILET BRUSH
ESCOBILLERO SUELO

238 0100

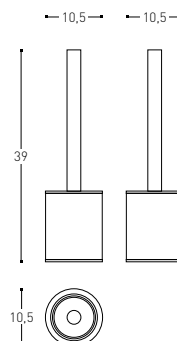

INCH 4.1x4.1x15.3



◎○△

FREE-STANDING OR WALL TOILET BRUSH
ESCOBILLERO SUELO/PARED

2510100

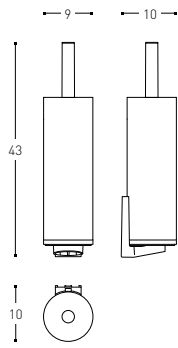

INCH 3.5x3.9x16.9



DRYWALL ANCHOR
TACO PLADUR

3410636

SPARE PART OF / RECAMBIO DE
2380120, 2380121, 2380145, 2380148, 2380149, 2380150, 2380158, 2380159, 2380164,
2380165, 2380166, 2380168, 2380171, 2380174, 2380186, 2380188, 2510154, 2510105,
2510100

SCREW MOUNTING SET (M5/M6)
JUEGO BIS SUJECIÓN (M5/M6)

3309100

SPARE PART OF / RECAMBIO DE

WALL MOUNTING SET (2 SCREWS)
ACCESORIO SUJECIÓN PARED (2 TORNILLOS)

3405800

SPARE PART OF / RECAMBIO DE

MOUNTING SET
ACCESORIO SUJECIÓN

3406500

SPARE PART OF / RECAMBIO DE
2380120, 2380164, 2380165, 2380166, 2380121

BASIC MOUNTING SET
ACCESORIO SUJECIÓN BÁSICO

3410018

SPARE PART OF / RECAMBIO DE
2380145, 2380159

ROUND WALL MOUNTING SET
ACCESORIO SUJECIÓN PARED REDONDO

3307600

SPARE PART OF / RECAMBIO DE
2380168

DISPENSER PUSH BUTTON + PUMP
PULSADOR + BOMBA DOSIFICADOR

3409020

SPARE PART OF / RECAMBIO DE
2510104, 2510105

DISPENSER PUMP
BOMBA DOSIFICADOR

3410682

SPARE PART OF / RECAMBIO DE
2510104, 2510105

SHELF
ESTANTE

3406600

SPARE PART OF / RECAMBIO DE
2380145

TOILET BRUSH GLASS
VASO ESCOBILLERO

3308300

SPARE PART OF / RECAMBIO DE
2380100

TOILET BRUSH STICK WITH BRUSH
PALO ESCOBILLERO CON CEPILLO

3410060

SPARE PART OF / RECAMBIO DE
2380100

3409017

SPARE PART OF / RECAMBIO DE
2510100

TOILET BRUSH BRUSH
CEPILLO ESCOBILLERO

3410313

SPARE PART OF / RECAMBIO DE
2380100, 2510100

3501100

SPARE PART OF / RECAMBIO DE
2510100







Free standing accessories

Complementos

482 **Saku**

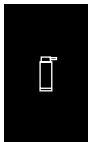
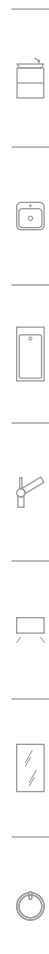

Saku

Design by **Ricard Ferrer**





Vegetable forms that grow and evolve; thus its name "saku", to flourish in japanese. Accessories with silky gloss or matt finish, ideal for nature-inspired bathrooms.

Formas vegetales que crecen y evolucionan, de ahí su nombre "saku", florecer en japonés. Complementos con acabados en brillo o mate sedoso, ideales para baños inspirados en la naturaleza.





FEATURES / CARACTERÍSTICAS

Complements in PMMA (Polymethyl methacrylate), coated in transparent paint with a gummy finish.

Complementos realizados en PMMA (poli metil metacrilato) recubiertos con pintura transparente en acabado gomoso.

AA
FINISHES / ACABADOS



25
Soft white
Blanco soft



26
Soft black
Negro soft



28
Soft gray
Gris soft



27
Soft stone
Piedra soft



23
Soft bluish gray
Gris azulado soft

05
Glossy white
Blanco brillo

06
Glossy black
Negro brillo





SOAP DISH
JABONERA



252 AA 32
SOFT / SOFT



252 AA 32
GLOSSY / BRILLO

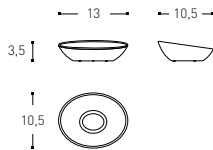

INCH 5.1x4.1x1.4



BRUSH-HOLDER
PORTACEPILLOS



252 AA 52
SOFT / SOFT



252 AA 52
GLOSSY / BRILLO

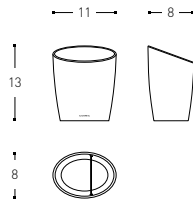

INCH 4.3x3.1x5.1



SOAP DISPENSER
DOSIFICADOR



252 AA 04
SOFT / SOFT



252 AA 04
GLOSSY / BRILLO

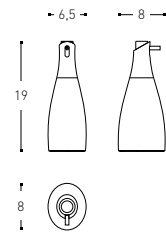

INCH 2.5x3.1x7.5



POT
FRASCO



252 AA 49
SOFT / SOFT



252 AA 49
GLOSSY / BRILLO

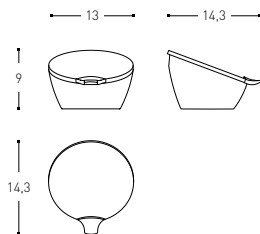

INCH 5.1x5.6x3.5



TOILET BRUSH
ESCOBILLERO



252 AA 00
SOFT / SOFT



252 AA 00
GLOSSY / BRILLO

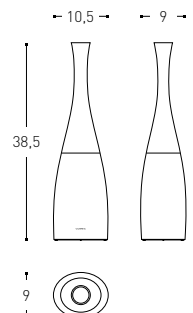

INCH 4.1x3.5x15.1

Spare parts | Recambios

DISPENSER PUMP
BOMBA DOSIFICADOR

3410682

SPARE PART OF / RECAMBIO DE
2520504, 2520604, 2522304, 2522504, 2522604, 2522704, 2522804

TOILET BRUSH BRUSH
CEPILLO ESCOBILLERO

3410267

SPARE PART OF / RECAMBIO DE
5250500, 2520600, 2522300, 2522500, 2522600, 2522700, 2522800



Displays

CODE / CODIFICACIÓN

3260822
3260822

COLLECTION
COLECCIÓN

EN
ES

LANGUAGE
IDIOMA

EN ENGLISH

ES ESPAÑOL



EXPOSITOR TOTEM
TOTEM DISPLAY

326 70 03

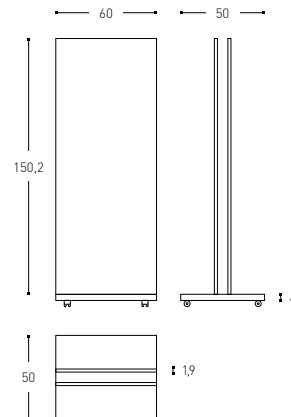

INCH 23.6x19.7x59.8 / 1.6 / 0.7





ARCHITECT
60X150,2 CM

3260803AA



BATH LIFE
60X150,2 CM

3260819AA



BLACK & WHITE
60X150,2 CM

3260827AA



EXTREME
60X150,2 CM

3260823AA



WORKING
60X150,2 CM

3260814AA



ASIDEROS
90X150,2 CM

3260915AA

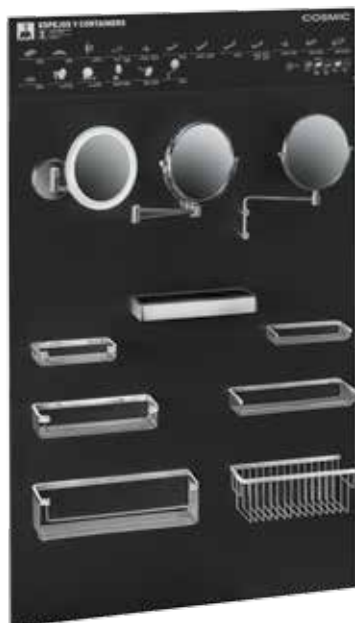

ESPEJOS Y CONTAINERS
90X150,2 CM

3260916AA



Materials



FLOAT GLASS (flat shelves and washbasin tops)

This material is solely mechanized, cut, and polished. Though we utilized the most durable thickness, special care must be taken to ensure this naturally fragile material will last. To maintain the appearance of this glass, avoid contact with hard or sharp materials that could scratch the surface. Many of these products have one side engraved with acid that should be facing down to facilitate cleaning and make any possible scratching less visible. We recommend using soapy water to clean both the top and bottom surfaces.



PRESSED GLASS (glasses and soap dishes in most collections)

This material is manufactured similarly to FLOAT glass, with the added steps of melting and shaping. To maintain the appearance of this glass, avoid contact with hard or sharp materials that could scratch the surface. To clean, we recommend the use of soapy water.



TEMPERED GLASS

This material is manufactured similarly to FLOAT glass, but also undergoes a thermal processing to increase its resistance. Though stronger than FLOAT glass, the same care should be applied. To maintain the appearance of this glass, avoid contact with hard or sharp materials that could scratch the surface. To clean, we recommend the use of soapy water.



MIRRORS

As we use only top quality raw materials and follow appropriate manufacturing processes, our mirrors have maximum protection against corrosion stains. However, it is highly important to avoid rubbing or scratching the underside of any mirror during installation, as this can lead to corrosion staining over time. We recommend the use of mild cleaning agents that contain no acetones or similar substances.



SYNTHETIC RESIN (CRISTALPLANT®)

Is a technologically advanced and unique compound, made up of high percentage of mineral extenders from nature (ATH derived from bauxite) as well as a small one of high-purity polyester and acrylic polymers; therefore, it is an inert, hypoallergenic and non-toxic material. 100% recyclable, practically fireproof (class 1), strongly UV-resistant, solid and non-porous, hygienic and healthy, resistant and agreeable to the touch for its velvety and natural stone-like finish. 100% restorable, i.e. it can bring back the original state and look by simply using an abrasive sponge and a detergent, thus removing even cigarette burning rings. These properties of durability and restorability make it an eco-compatible material.



CRISTALPLANT BIOBASED®

Material made up of 50% natural minerals (aluminium trihydrate -ATH- derived from bauxite) and 50% high-purity polyester bioresins. Plant resins: this is the first ecologically sustainable solid surface, consisting of resins of plant origin and extremely pure natural minerals. It is an inert, hypoallergenic, non-toxic material. It is practically inflammable, certified Class 1 fire resistance. It is highly resistant to ultraviolet rays. It regains its original appearance with just soapy water and a scrubber.



PHENOLIC RESIN

This material is a high pressure laminate (HPL) with a decorative surface. Typically the superficial layer consists of thermo-hardened resin-treated plywood. The special texture and durability of this material makes it very resistant to impact and scratching, and it is completely waterproof. Specially designed for use in places where hygiene is of the utmost importance, this material can be cleaned frequently with active detergents, chemical agents, or organic solvents.



VENEERED WOOD

Plywood of waterproof DM + sheets of: oak or American walnut. To avoid its yellowing, they are varnished with high quality materials. This kind of surface must be treated and cleaned like many other pieces of furniture, using specific products like wood care products.



LACQUERED WOOD

This material is made from 16mm-thick double-faced waterproof MDF plywood. Its high quality varnish provides a bright or matte finish and prevents yellowing. Due to its delicate lacquered surface, we recommend the use of mild cleaning products, avoiding solvents or any abrasive substances.



PVC / PVC

Polyvinyl chloride (PVC) is a polyvinyl chloride polymer used to manufacture numerous products and is also applied in making boards, panels, windows, shutters, etc. Its durability, colour stability, watertightness and moisture proof properties make PVC an ideal material for bathroom and kitchen furniture. The material can be cleaned quickly and easily with just soap and water, although its resilience means most cleaning products can also be used.



PLASTIC

We use various technical plastics with different features to meet the manufacturing and aesthetic needs of each product. These include ABS (with or without chrome), PP, PA, PE, PC, PS, etc. We recommend maintaining decorative items the same way you would chrome brass pieces. Avoid the use of solvents.



ACRYLIC GLASS

The polymethylmethacrylate (PMMA) is known as one of the "engineering plastics", and is obtained through the polymerisation of methyl methacrylate. It stands out from other plastics due to the fact that it is impact resistant, weather resistant—as it does not undergo any significant ageing in ten years of outdoor exposure—resistant to UVA rays and scratch resistant. Due to its absolute transparency (it is the most transparent plastic), it is most commonly used in vehicle headlights, optics, medicine or partition panels. For use in architecture and decoration, it is lighter than glass and provides greater resistance to impact, meaning it can be a good substitute in many situations.



STAINLESS STEEL (bright and matte)

This material is made of certain alloys such as AISI 303, 304, 316, or 430, depending on the requirements for each item. To maintain its quality, regular maintenance must be applied. To clean this material, we recommend the use of soapy water, followed by a thorough rinsing. Finish by wiping the surface dry with a cloth or soft leather. Avoid using strong or abrasive substances, especially those containing acids or bleach. If cleaned inappropriately, this material can develop lime scale deposits that cause deterioration.



BRASS OR SIMILAR ALLOYS (bright chrome or matte chrome)

We apply a nickel or chrome coating over a brass base to make this material. To maintain its quality, regular maintenance must be applied. To clean this material, we recommend the use of soapy water, followed by a thorough rinsing. Finish by wiping the surface dry with a cloth or soft leather. Avoid using strong or abrasive substances, especially those containing acids or bleach. If cleaned inappropriately, this material can develop lime scale deposits that cause deterioration.



ALUMINUM (anodized)

We manufacture this AA6060 alloy in accordance with the required specific industrial standards. This material is protected by an anodizing treatment that also provides color and texture. To clean this material, we recommend the use of soapy water, followed by a thorough rinsing. Finish by wiping the surface dry with a cloth or soft leather. Do not use abrasive solvents, particularly those containing acids or bleach.



GLASS-LINED STEEL (VIT-TECH)

Cutting-edge, 100% recyclable, non-porous and hygienic material made from pre-enamelled steel fired at over 800°. The vitreous enamel withstands corrosion, high temperatures and chemical agents. This durability means it can be used for a wide range of functional applications in bathtubs, shower trays and washbasins, as well as for ovens and coatings. It is an easy to clean material that does not require special cleaning products.



TECKSTONE

Advanced formula composed by natural minerals (calcium carbonate and quartz) mixed with resin. The surface is covered by Gelcoat Premium Maxguard™ film, with plastic fibre and polymer, which provides the needed durability and resistance for an intensive daily use. It is a solid surface with excellent physic-mechanical properties that supplies important design possibilities. Its capacity of moulding allows reproducing forms with a great precision and with less curvature radius. Teckstone is very hard, resistant and compact; being a non porous material and without angles, it is very easy to maintain, the stains can be eliminated without effort and it is easy to clean. For the maintenance, wash with a soft cloth and dry with a chamois. We recommend not to use abrasive cloth or scourers, acid detergents, bleach ... and/or cleaning products with unknown components.



MARBLE

The Carrara marble (white matt and glossy finish) extracted from the Tuscany quarry at Carrara. With white background and its distinctive grey blue color marble vein covering the whole surface.

The Marquina marble (intense black and glossy finish), elegant and classic, extracted from the Marquina quarry (Vizcaya), characterized by its white vein. The less veins the better.

The Brescia marble (Brown matt and glossy) from the region of Lombardy (Italy). It is considered as one of the most sumptuous Italian marble.



PORCELAIN

Depending on the specifications of the item, either porcelain or porcelain stoneware is used to manufacture our washbasins (although differences between them may be imperceptible by the user). The vitrified finish gives the surface hardness, colour, shine, non-porosity and hygiene and makes this product ideal for its use. Besides this, any product designed for the bath cleaning can be used for the cleaning of this vitrified finish as well. Do not blow with hard, heavy objects as they may damage the surface or even break the product.



Materiales



VIDRIO FLOAT (Estantes y encimeras)

Realizado con vidrio tipo FLOAT estándar sin ningún otro tratamiento posterior más que la mecanización, corte y pulido necesarios. Se trata, pues, de un material que por su propia naturaleza es frágil y a pesar de que en cada caso se ha utilizado el espesor más adecuado, debe tenerse un especial cuidado en su uso. Para conseguir que el buen aspecto inicial del producto se mantenga a lo largo de los años, se recomienda no depositar artículos fabricados con materiales duros que pudieran rayar la superficie. Muchos de nuestros artículos tienen una cara gravada al ácido (mate o traslúcida). Se recomienda que esta cara mate, se instale en la cara inferior, para facilitar la limpieza, y evitar que posibles ralladuras sean más visibles. Para la limpieza de ambas superficies es suficiente con agua jabonosa.



VIDRIO PRENSADO (Vasos y jaboneras de la mayoría de nuestras series)

Material muy similar al vidrio FLOAT utilizado en estantes y encimeras, este vidrio fundido es conformado en un molde. El uso y cuidados deben ser los mismos que para estantes y encimeras.



VIDRIO TEMPLADO

Vidrio FLOAT sometido a tratamiento térmico para aumentar su resistencia.



ESPEJOS

Cosmic utiliza materia prima de primera calidad que, unido a un correcto proceso de fabricación de los espejos, aseguran la mayor protección contra las manchas por corrosión. Es importante evitar, en especial durante el proceso de instalación, roces o ralladuras en la cara oculta del espejo, que con el tiempo podrían dar origen a manchas de corrosión. Para su limpieza se recomienda utilizar productos suaves y en ningún caso acetonas o similares.



RESINA SINTÉTICA (CRISTALPLANT®)

Es un material compuesto tecnológicamente avanzado y único, formado por un porcentaje elevado de minerales naturales (trihidrato de aluminio -ATH- derivado de la bauxita) y un bajo porcentaje de polímeros poliésteres y acrílicos de gran pureza; se trata, por lo tanto, de un material inerte, hipoalérgico y no tóxico. Es un material que puede reciclarse al 100%, prácticamente ignífugo (clase 1), con una óptima resistencia a los rayos ultravioletas; es compacto, no poroso, higiénico, resistente y agradable al tacto gracias a su acabado aterciopelado, similar al de la piedra natural. Puede recuperar completamente su aspecto original utilizando simplemente detergentes y estropajos abrasivos para eliminar incluso las quemaduras de cigarrillo. Sus propiedades de duración y capacidad de recuperación lo convierten en un material ecológico.



CRISTALPLANT BIOBASED®

Material compuesto formado por un 50% de minerales naturales (trihidrato de aluminio -ATH- derivado de la bauxita) y un 50% de biorresinas de poliéster de gran pureza. Es el primer solid surface eco sostenible que deriva de materias primas resinosas de origen vegetal, procedentes de cultivos certificados, mezcladas con minerales naturales de extrema pureza. Es un material inerte, hipoalérgico y no tóxico. Es prácticamente ignífugo, con certificado de resistencia al fuego Clase 1. Presenta una óptima resistencia a los rayos ultravioletas. Puede recuperar completamente su aspecto original utilizando simplemente agua jabonosa y estropajos abrasivos.



RESINA FENÓLICA

La Resina Fenólica o Stratificato es un laminado de alta presión (HPL) con superficie decorativa. En general, la capa superficial está constituida por una superficie dura, basada en resinas de melamina, mientras que el grueso está constituido por un contrachapado impregnado de resina termo endurecida que le confiere al material una excepcional resistencia al impacto. Su especial textura y su durabilidad proporcionan a nuestros muebles una excelente resistencia al rayado. Gracias a su superficie perfectamente impermeable es un material resistente al desgaste, al agua y al vapor. A fin de dar solución a las normas más exigentes en materia de higiene, puede limpiarse frecuentemente con detergentes activos ofreciendo alta resistencia a los agentes químicos y disolventes orgánicos. Especialmente indicado para su uso en áreas donde la higiene desempeña un papel fundamental.



MADERA CHAPADA

DM hidrófugo + chapa de roble o nogal americano. Barnizado con materiales de primera calidad que evitan el amarillamiento. Este tipo de superficies deben ser tratadas y limpiadas como cualquier otro mueble, con productos específicos para la madera.



MADERA LACADA

Aglomerado DM hidrófugo de 16mm melaminado dos caras y lacado en acabados brillo y mate con barnices de primera calidad resistentes y que evitan el amarillamiento. Las superficies lacadas son delicadas y deben ser tratadas y limpiadas cuidadosamente, utilizando productos específicos para estas superficies. No usar nunca disolventes o productos abrasivos.



PVC

El cloruro de polivinilo (PVC) es un polímero de cloruro de vinilo que se emplea para la fabricación de multitud de productos, encontrando aplicación en la realización de tableros, paneles, ventanas, persianas, etc. La larga durabilidad, estabilidad del color, estanqueidad al agua y resistencia a la humedad, son las características que hacen del PVC un material idóneo para muebles de baño y de cocina. La limpieza de este material es fácil y rápida y se realiza con agua y jabón, aunque por su resistencia permite el empleo la mayoría de productos de limpieza.



PLÁSTICO

Cosmic utiliza plásticos técnicos de distintas características en función de las necesidades de fabricación y estéticas de cada producto o pieza. Entre los plásticos utilizados están: ABS (cromado o no), PP, PA, PE, PC, PS, etc. En el caso de piezas decorativas deben tenerse los mismos cuidados en la limpieza y mantenimiento que para una pieza de latón cromado. Evitar el uso de disolventes.



CRISTAL ACRÍLICO

El Polimetilmetacrilato (PMMA) es conocido como uno de los "plásticos de la ingeniería", se obtiene de la polimerización del metacrilato de metilo. Destaca frente a otros plásticos por la resistencia a los impactos, a la intemperie ya que no sufre un envejecimiento apreciable en diez años de exposición exterior, a los rayos UVA, y por la resistencia al rayado. Por su transparencia máxima (es el plástico más transparente) las funciones más habituales van desde los faros de los vehículos, la óptica, la medicina o mamparas separadoras. Para su uso en la arquitectura y decoración se beneficia de un peso menor al del vidrio y mayor resistencia a impactos por lo cual puede ser un buen sustituto en muchas ocasiones.



INOX (Acero inoxidable brillo y mate)

Para la fabricación de nuestros productos de acero inoxidable, se utilizan aleaciones como AISI 303, 304, ó 430 en función de las necesidades de cada pieza. Para asegurar una larga vida al producto es necesario realizar un mantenimiento periódico consistente en conservar la pieza limpia. Para la limpieza utilizar agua jabonosa, luego aclarar con abundante agua y finalmente secar con un paño o gamuza suave. Nunca utilizar productos fuertes, que contengan ácidos, lejía, o sean abrasivos. Los depósitos de cal, por falta de una limpieza regular, son el principal riesgo de deterioro.



LATÓN O ALEACIONES ANÁLOGAS (cromo brillante y cromo mate)

Sobre la base de latón se aplica un recubrimiento de Níquel y Cromo. Para asegurar una larga vida al producto es necesario realizar un mantenimiento periódico que consiste únicamente en mantener la pieza limpia. Para la limpieza utilizar agua jabonosa, luego aclarar con abundante agua y finalmente secar con un paño o gamuza suave. Nunca utilizar productos fuertes, que contengan ácidos, lejía, o sean abrasivos. Los depósitos de cal, por falta de una limpieza regular, son el principal riesgo de deterioro de este producto.



ALUMINIO (Anodizado)

Nuestros productos de base aluminio, aleación AA6060, son fabricados bajo los estándares industriales de esta materia prima, y son sometidos, cuando es necesario, a un tratamiento de anodizado que les da protección, color y textura. Para la limpieza utilizar agua jabonosa, luego aclarar con abundante agua y finalmente secar con un paño o gamuza suave. Nunca utilizar productos fuertes, que contengan ácidos, lejía, o sean abrasivos.



ACERO VITRIFICADO (VIT-TECH)

Material tecnológicamente avanzado y 100% reciclable que nace de la cocción de una superficie de acero esmaltada previamente. Es un material no poroso, higiénico y resistente a la corrosión, a las altas temperaturas y a agentes químicos debido a la naturaleza vítrea del esmalte. Esta característica le confiere una gran dureza permitiendo una amplia gama de aplicaciones en bañeras, platos de ducha y lavabos así como hornos y revestimientos. Es un material de fácil limpieza que no requiere la utilización de productos de limpieza específicos.



TECKSTONE

Formulación avanzada compuesta de minerales naturales (carbonato de calcio y cuarzo) mezclados con resina. La película Gelcoat Premium Maxguard™, con fibras de plástico y polímeros, recubre la superficie proporcionando la durabilidad y resistencia que necesita el uso diario intensivo. Se trata de una superficie sólida con excelentes propiedades físico-mecánicas que ofrece grandes posibilidades de diseño. Su capacidad de moldeo permite reproducir formas con gran precisión y con menores radios de curvatura. Teckstone es muy resistente, compacto y de gran dureza. Al ser un material no poroso y carente de juntas, su mantenimiento es muy sencillo, las manchas se eliminan sin esfuerzo y es de fácil limpieza. Para su mantenimiento, limpiar con un paño suave humedecido con agua y secar con una gamuza. No usar trapos o estropajos abrasivos, detergentes ácidos, lejías... y/o productos de los que desconozca su composición.



MÁRMOL

Mármol carrara (Blanco mate y brillo) extraído de las canteras de la Toscana italiana. Con fondo blanco y distintivas vetas de color azul grisáceo claro repartidas por toda la superficie.

Mármol marquina (negro mate y brillo), elegante y clásico, se extrae de las canteras en Marquina (Vizcaya), caracterizado por sus vetas de color blanco. Cuantas menos vetas más apreciado.

Mármol brescia (marrón mate y brillo) extraído de las canteras de la región de Lombardía (Italia). Considerado uno de los mármoles italianos más suntuosos.



PORCELANA

Para la fabricación de nuestros lavabos se utiliza porcelana o gres porcelánico según las características de la pieza (aunque las diferencias entre ambos no son perceptibles para el usuario). El acabado final vitrificado da a la superficie la dureza superficial, color, brillo, no porosidad e higiene idóneos para su uso en el baño. Este vitrificado permite la limpieza con cualquier producto destinado a la limpieza del baño. Evitar golpes con objetos duros y pesados ya que pueden dañar la superficie e incluso llegar a romper la pieza.



Sales conditions

EXPORT GENERAL SALES CONDITIONS

- 1**

The sales of INDUSTRIAS COSMIC S.A.U. are ruled by the herewith detailed general sales condition and the delivery of any order implies the buyer's acceptance of these general conditions.
- 2**

The products can be modified, replaced or cancelled at any time and all information of any kind included in our catalogues, price lists or advertising materials are indicative.
- 3**

Orders received from customers or through our salesmen are always subject to our previous approval and are considered confirmed unless otherwise specified.
- 4**

No order accepted by INDUSTRIAS COSMIC, S.A.U. can be amended or cancelled without our approval. The customer, as far as he is concerned, cannot return any goods to us without our previous acceptance or consent. In case the customer wants to cancel or amend an order that has been already shipped, due to INDUSTRIAS COSMIC, S.A.U. external causes, the customer will be charged with a € 50 invoice (VAT non included) as return management expenses.
- 5**

Goods will be invoiced in accordance with our current price list at the moment of shipment. The prices are F.O.B. Barcelona for orders above € 1,500; for orders below € 1,500 goods will be shipped under Ex-Works conditions.
- 6**

Unless otherwise agreed, the payment terms are:
-Irrevocable Letter of Credit at sight
-Advanced Bank Transfer
-Cash Against Documents
- 7**

INDUSTRIAS COSMIC, S.A.U. offers two years guarantee, in exception of the indicated in the price list, against raw material and manufacturing defects. The guarantee is valid from the time of purchase by the final customer. To confirm the date of purchase, the invoice of the consumer should be provided. The guarantee consists of the replacement of the defective piece that impedes the regular use of the item, except in case of improper use, incorrect assembly or installation, natural wear and tear, improper maintenance or, chemical, electrochemical or electrical influences. We are not responsible for all the damage brought about by misuse or bad installation of the products and won't accept any indemnities for the replacement of defective pieces or any demands for damage.
- 8**

INDUSTRIAS COSMIC, S.A.U. always try to minimize the customer service time and to meet the lead time requirements on our customers' orders as much as possible. In case we cannot satisfy them, customers will be duly advised.
- 9**

Ordered COSMIC products will be delivered under reservation of title in favour of INDUSTRIAS COSMIC, S.A.U. until all payment obligations by the purchaser have been met in full.
- 10**

In case of outstanding payments, the return and bank expenses are on the purchaser's. INDUSTRIAS COSMIC S.A.U. has the right to block all orders accepted as long as the outstanding payments are not sorted out.
- 11**

In case of claims regarding the interpretation or execution of the herewith sales conditions, will be competent the courts of our head office's jurisdiction.

Condiciones de venta

CONDICIONES GENERALES DE VENTA EXPORTACIÓN

- 1**

Las ventas de INDUSTRIAS COSMIC, S.A.U. se realizan según las condiciones generales aquí expuestas y la entrega de cualquier pedido supone la aceptación, por parte del comprador, de dichas condiciones generales de venta.
- 2**

Los productos se pueden modificar, reemplazar o suprimir en todo momento y la información de cualquier naturaleza contenida en nuestros catálogos, tarifas o material publicitario es indicativa.
- 3**

Los pedidos recibidos directamente de los clientes o realizados por nuestros representantes en nombre de ellos siempre estarán sujetos a nuestra aceptación. INDUSTRIAS COSMIC, S.A.U. da por confirmados todos los pedidos recibidos y, si no hay notificación específica se entenderán como aceptados.
- 4**

Ningún pedido aceptado por nosotros se podrá retractar ni anular sin nuestra aceptación. El cliente, por su parte, no podrá efectuar ninguna devolución de mercancía sin nuestro consentimiento previo. En el caso de anulación o modificación por parte del cliente y por causas ajenas a INDUSTRIAS COSMIC, S.A.U., de un pedido que ya haya sido expedido, se le facturará al cliente un importe de 50€ netos (IVA no incluido) en concepto de gastos de gestión y transporte.
- 5**

La mercancía será facturada de acuerdo con nuestra tarifa vigente en el momento del envío. Los precios serán F.O.B. Barcelona para pedidos superiores a 1.500€. Los pedidos inferiores a 1.500€ serán enviados ExWorks.
- 6**

De no existir otro acuerdo, las condiciones de pago serán:
-Letra de crédito irrevocable a la vista
-Transferencia por avanzado
-Contado contra documento
- 7**

INDUSTRIAS COSMIC, S.A.U. ofrece una garantía de 2 años, excepto en los casos indicados en la tarifa, contra todos los defectos de materia prima y fabricación válida a partir del momento de adquisición por parte del cliente final. A fin de determinar la fecha de adquisición será imprescindible la presentación de la factura de compra. Esta garantía consistirá en la sustitución de la pieza que determine su irregular funcionamiento, salvo por razones de uso inadecuado, montaje o instalación incorrectos, mantenimiento indebido, desgaste del uso diario o defectos provocados por reacciones químicas, electroquímicas o eléctricas. La garantía excluye de responsabilidad a INDUSTRIAS COSMIC, S.A.U. de todas las consecuencias derivadas del funcionamiento o instalación de nuestros productos y esta no reconoce ninguna indemnización por la sustitución de artículos defectuosos ni demanda por daños y perjuicios.
- 8**

INDUSTRIAS COSMIC, S.A.U. intenta siempre reducir al máximo los tiempos de servicio al cliente, ajustándose en lo posible a los requisitos de plazo solicitados expresamente en el pedido y, en caso de no poder satisfacerlos, se enviará una notificación.
- 9**

Los productos marca COSMIC, objeto de pedido, se entregarán bajo reserva de dominio a favor de INDUSTRIAS COSMIC, S.A.U. hasta el total cumplimiento de las obligaciones de pago por parte del comprador.
- 10**

En caso de impagados, se incurre en un cargo por devolución, más los gastos de financiación actuales en el mercado. INDUSTRIAS COSMIC, S.A.U. se reserva el derecho de retener los pedidos en curso hasta solucionar los efectos pendientes.
- 11**

Las disputas referentes a la interpretación o a la ejecución de estas condiciones generales de venta pasarán a ser competencia de los tribunales de nuestra jurisdicción.

COSMIC

ART DIRECTION
COSMIC STUDIO

GRAPHIC DESIGN
AT COMUNICACIÓ

Ref. 3140637 / EN-ES

COSMIC

INDUSTRIAS COSMIC, S.A.U.
CERDANYA, 2
POL. IND. LA BORDA
P.O. BOX 184
08140 CALDES DE MONTBUI BARCELONA SPAIN
CENTRAL OFFICE TEL +34 938 654 277 FAX +34 938 654 264
INTERNATIONAL PHONE TEL +34 938 664 101 FAX +34 938 654 264
SHOWROOM CERDANYA, 2 08140 CALDES DE MONTBUI BARCELONA SPAIN

info@icosmic.com
www.icosmic.com



429960 498580

8